

# PRIVATE LANDS

# INTRODUCTION



Cooperative Extension Service, Kansas State University, Manhattan, Kansas

All educational programs and materials available without discrimination on the basis of race, color, national origin, sex, age, or disability.

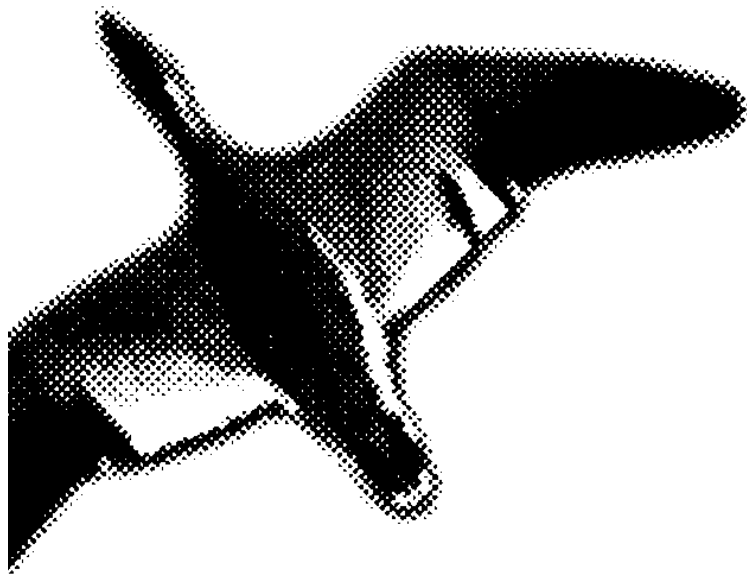

# WILDLIFE MANAGEMENT

A Technical Manual  
&  
Correspondence  
Course

---

---

# Table of Contents

<i>Foreward</i> .....	<i>iii</i>
<i>Acknowledgements</i> .....	<i>v</i>
<i>How to Use This Manual</i> .....	<i>vii</i>
<i>About the Authors</i> .....	<i>ix</i>

## *Section I*

### Understanding How the System Works

#### **Chapter**

1. Introduction: What Are Wildlife and Wildlife Management? .....	3
2. Where Are We Now and How Did We Get There? A Lesson from History and Wildlife Legislation .....	11
3. Understanding How the System Works: Basic Ecological Principles .....	21
4. Food, Water, Cover, and Space: What Wildlife Require .....	31
5. Animals Everywhere: The Basics of Population Dynamics .....	41
6. Inventory, Goals, and Guidelines: The Process of Managing Wildlife .....	49
7. Aerial Photographs, Maps, and Habitat: Creating a Planning Document .....	57
8. How Many Wildlife Are on My Property .....	63
9. An Introduction to Pesticides and Their Effects .....	69

## *Section II*

### Wetlands/Waterfowl

10. Wetland Ecology and Value .....	79
11. Wetland Management .....	91
12. Waterfowl Management .....	103
13. Wood Duck .....	115
14. Mallard .....	121
15. Geese .....	127

## *Section III*

### Habitats

16. Management of Native Grasslands .....	135
17. Rangeland Management for Wildlife .....	157
18. Woodland Management for Wildlife .....	163
19. Wildlife Management on Croplands .....	173
20. Habitat Improvement Practices and Guidelines .....	179
21. Backyard Wildlife Habitat Management .....	197

---

***Section IV***

Economics

22. Economic Returns of Wildlife to the Landowner ..... 211  
23. Private Property: Rights and Liabilities ..... 221  
24. Assessing the Farm/Ranch Recreation Potential ..... 233  
25. Marketing Farm/Ranch Recreation ..... 257

***Section V***

Fish

26. Producing Fish and Wildlife from Kansas Ponds ..... 265

***Section VI***

Wildlife

27. Ring-Necked Pheasant Management ..... 293  
28. Bobwhite Quail Management ..... 299  
29. Greater Prairie Chicken Management ..... 311  
30. Mourning Dove Management ..... 317  
31. Wild Turkey Management ..... 323  
32. Attracting Songbirds to Your Yard ..... 329  
33. Big Game Management ..... 337  
34. Tree Squirrel Management ..... 347  
35. Cottontail Rabbit Management ..... 353  
36. Furbearer Management ..... 357  
37. Predators ..... 377  
38. Mussels, Madtoms, Bats, and Darters: Kansas' Endangered Species ..... 381

***Appendix***

Agencies ..... 395

---

# Foreward

Our state boasts a surprising mixture of wildlife. That diversity depends upon our vigilance. As pressure continues to build on an ever-dwindling natural environment in Kansas, it is vital that we, as property owners, become more than just good stewards of the land. We must become proactive stewards, willing to dedicate our own time and resources to take measures that anticipate environmental changes.

This manual was developed by wildlife professionals and members of our Company's Environmental Task Force in an effort to inspire our employees to include wildlife habitat management in their daily routine of managing thousands of acres our Company owns and impacts. We also hope it becomes a useful guide in how all Kansans approach land management in the future.

To leave this land in better shape than when you found it is a creed ingrained in the Kansas character. However, a new generation of Kansans won't necessarily learn the basics of good land stewardship at a young age on the seat of a tractor. That responsibility falls to every Kansas resident. Western Resources is proud to sponsor this manual because our past and future is rooted in this unique prairie ecosystem. This is your native land; it is yours to lose, preserve, or enhance for the next generation of Kansans.

*John E. Hayes, Jr.*  
Chairman of the Board, President  
and Chief Executive Officer  
Western Resources

---

---

# Acknowledgments

We owe Dr. Tom Barnes and his colleagues in Kentucky a debt of gratitude for their original work in developing the first Private Lands Wildlife Management Manual and for granting us permission to adopt and modify their manual to conditions in Kansas. In some cases, entirely new material for Kansas was written. For this, we owe the “new” authors our sincere thanks for taking extra time and effort to bring their information to Kansas private landowners and managers.

We have listed all the authors of the chapters and something about each of them in the following sections entitled, “About the Authors.”

Dr. Edward Kozicky spent many hours editing and, in some cases, rewriting parts of the manual. We appreciate his time and efforts and we thank the Welder Wildlife Foundation for allowing Dr. Kozicky to work on this project.

There are others who deserve special credit for the production of this manual. Brandy Nowakowski, secretary for the Department of Animal Sciences and Industry, typed and managed the text development—working with this project from the beginning to completion. Rebecca Schwenke, office specialist for the Department of Communications, transferred the text to a desktop publishing program and established the page formats. We thank these two for their help.

Permission to reprint illustrations by Charles W. Schwartz has been granted by the following:

From *Wildlife Drawings*. Copyright 1980 by the Conservation Commission of the State of Missouri. Reprinted by permission.

From *The Wild Mammals of Missouri*, by Charles W. and Elizabeth R. Schwartz, by permission of the University of Missouri Press. Copyright 1981 by the Curators of the University of Missouri.

Artwork also provided by Jerry Thomas, Manhattan, Kansas.

This manual for Kansas people would not have been possible had it not been for the financial support of The Western Resources Council and we thank this organization for its support of this project.

**Charles Lee, Editor**

Kansas Department of Wildlife and Parks  
Room 127, Call Hall  
Kansas State University  
Manhattan, KS 66506

**F. Robert Henderson, Editor**

Extension Specialist, Animal Damage Control  
Room 128, Call Hall  
Kansas State University  
Manhattan, KS 66506



---

# How to Use This Manual

**T**he purpose of this project is to provide an educational opportunity for private landowners who wish to learn how to manage wildlife. The manual has been designed for home study. The user can check their own work or they can fill in the questions at the end of each chapter and mail them to the editors. These will be checked for accuracy and mailed back with comments. At the end of the course, when all chapter questions have been answered, sent in, checked and returned, a certificate of completion will be awarded. This course will provide you with a basic understanding of how you can manage your property to benefit wildlife. The course is also designed to create an awareness of why and how wildlife management works. You will also get insight in how rangeland, wetlands, agricultural lands and ponds can be managed for maximum recreational, aesthetic or economic benefits. It will also help you develop your management objectives and organize activities to meet those objectives.

## *Course Content*

This course is divided into six sections with chapters covering most aspects of rangeland, woodland, and wetland wildlife management. Emphasis is on management for wildlife production, but management for other uses (rangeland, timber, recreation, and livestock production) is also discussed as it relates to the wildlife resource in Kansas. The course is practical and designed for the person without a background in wildlife management.

## *Highlights of the Sections*

### **Section I—Understanding How the System Works**

The nine chapters in this section discuss the basic principles of ecology and wildlife management. These initial chapters provide a framework for understanding why wildlife biologists recommend certain management practices. Topics include a brief chapter on history and legislation as well as chapters on basic ecology, wildlife habitat requirements, fluctuations in animal populations, developing objectives, and the planning process.

### **Section II—Wetlands and Waterfowl Management**

The six chapters in this section describe the wetland resource in Kansas, what has happened to this resource in the past, why wetlands are important habitats, how wetlands

can be managed for waterfowl and other wildlife, and how you can restore wetlands on your property. Other chapters are devoted to describing how our ducks and geese are managed by state and federal wildlife agencies and life history strategies of wood ducks, mallards, and geese.

### **Section III—Habitat Management**

The six chapters in this section describe what plant communities can be found in Kansas' diverse landscape; the basic principles of rangeland management, including how rangelands can be managed to maximize wildlife benefits, wildlife management on agricultural croplands, and the woodland resource in Kansas, also included are chapters about habitat manipulations you can use to create wildlife habitat on your property, including your backyard.

### **Section IV—Economics**

These four chapters discuss how wildlife can yield economic returns. The rights and liabilities of private landowners who manage for outdoor recreational use is discussed. Chapters on how to evaluate your economic potential and how to market that potential are included.

### **Section V—Fish**

The chapter on producing fish and wildlife is detailed and includes sections on fish management, pond construction, aquatic vegetation management, and fishing techniques.

### **Section VI—Wildlife**

The twelve chapters in this section deal with some terrestrial wildlife natural history and management. Chapters include information on species most commonly managed for in Kansas as well as information on predator ecology, and the special concerns involved in threatened and endangered species management.

The editors hope that each participant will gain a better understanding about the management of wildlife. At the same time, we hope that private landowners will begin to understand the technical difficulties and political realities faced by public agencies when trying to manage public resources on private lands. State agencies cannot successfully maintain wildlife populations without private landowner cooperation. Participants who complete this course



---

will be able to help their neighbor as well as others, thereby extending this new understanding. Youth can be taught and shown the results of wildlife management practices. Only with such broad-based educational approaches to wildlife management can we expect good landowner stewardship and understanding.

**Charles Lee, Editor**

Kansas Department of Wildlife and Parks  
Room 127, Call Hall  
Kansas State University  
Manhattan, KS 66506

**F. Robert Henderson, Editor**

Extension Specialist, Animal Damage Control  
Room 128, Call Hall  
Kansas State University  
Manhattan, KS 66506

---

## About the Authors

**THOMAS G. BARNES, Assistant Extension Professor, University of Kentucky.** Tom has been the Extension wildlife specialist in the Department of Forestry at the University of Kentucky since 1988. Before coming to UK, Tom worked as a wildlife technician for the South Dakota Game, Fish and Parks Department, and the U.S. Fish and Wildlife Service in South Dakota as an endangered species wildlife biologist. Tom has a B.A. in biology from Huron College, an M.S. in wildlife and fisheries sciences from South Dakota State University, and a Ph.D. in wildlife and fisheries sciences from Texas A&M University. His current responsibilities include developing and coordinating Extension wildlife programs throughout the state of Kentucky. Tom's current research interests include evaluation of the nutritional carrying capacity of wildlife habitat.

**TERRY BIDWELL, Associate Professor of Rangeland Resources and State Extension Specialist at Oklahoma State University.** Terry has been the Extension Specialist at Oklahoma State University since 1988. He received an A.D. in Forest Technology from Eastern Oklahoma State College, B.S. and M.S. in Wildlife Ecology from Oklahoma State University, and a Ph.D. in Range Science from Oklahoma State University. Previous positions included Graduate Research Assistant with the Oklahoma Cooperative Fish and Wildlife Research Unit (USFWS), and District Conservationist and Acting State Biologist with the USDA Soil Conservation Service in Oklahoma and Colorado. His research interests include historical fire effects and landscape patterns of Great Plains vegetation types, effects of fire and herbivory by large grazing animals on endangered species, and the effects of herbicides and fire on birds indigenous to prairies and shrublands, particularly lesser and greater prairie chickens.

**ART BOEBINGER, Lands Coordinator, Kentucky Department of Fish and Wildlife Resources (KDFWR).** Art has been the lands coordinator for the KDFWR since 1985. He held numerous positions with the Kentucky Department of Natural Resources, Kentucky Nature Preserves Commission, and the U.S. Army Corps of Engineers before joining the KDFWR. Art is a native Kentuckian and has a B.S. from Cumberland College and an M.S. in botany from Eastern Kentucky University. His current responsibilities include evaluation and acquisition of properties for the KDFWR land-acquisition program.

**PETER T. BROMLEY, Extension Specialist In-Charge and Professor of Zoology, Department of Zoology, North Carolina State University in Raleigh.** Peter's major extension program links wildlife with sustainable agriculture, and he directs graduate research on quail ectotoxicology. He collaborated with Ms. Stinson when he was Wildlife Extension Specialist with the Virginia Cooperative Extension Service.

**GEORGIA BRYAN, Extension Associate, Iowa State University (ISU) Extension Wildlife Programs.** Georgia received her B.S. in wildlife from the University of Wisconsin—Stevens Point in 1986 and her M.S. in wildlife biology from Iowa State University in 1989. She has authored and co-authored six wildlife Extension publications in the *ISU Managing Iowa Habitats* and *Managing Iowa Wildlife* series and a 1993 curriculum for teachers, *Sustainable Agriculture and Wildlife: Piecing Together a Habitat Puzzle*.

In addition to writing, she also presents workshops on wildlife and wildlife damage management, especially in backyard situations. Her interactive techniques have been popular at Master Gardener programs, Shade Tree Shortcourse, and with many other groups.

**CHARLES ELLIOTT, Associate Professor, Eastern Kentucky University (EKU).** Chuck has been on the faculty at EKU since 1985. Before coming to EKU, Chuck was employed as a terrestrial ecologist with an environmental consulting firm in Alaska. He has a B.S. in wildlife from Frostburg State College and an M.S. in wildlife from the University of Idaho and Brigham Young University. His Ph.D. in wildlife is from the University of Alaska at Fairbanks.

**LLOYD B. FOX, Program Specialist I (Furbearer) Kansas Department of Wildlife and Parks.** Lloyd received a B.S. in Wildlife Science from Cornell University and a Ph.D. from the State University of New York, College of Environmental Science and Forestry. He studied bobcat ecology in Kansas, New York, and West Virginia. He worked as a District Wildlife Biologist from 1973 to 1976 and as a Program Specialist working with furbearers since 1982, for the Kansas Department of Wildlife and Parks. Lloyd administered the furharvester education program in Kansas. He is currently working on swift fox ecology studies within sustainable agricultural systems.

---

**DONALD W. GABELHOUSE, JR., Current Administrator of the Fisheries Division at the Nebraska Game and Parks in Lincoln, Nebraska.** Don was formerly Pond Fisheries Investigator, Kansas Department of Wildlife and Parks at Emporia, Kansas. His undergraduate work in fisheries was at the University of Nebraska and graduate work was at the University of Missouri for a master's degree in division administration. Don was the principle author on the pond management text, and he gave an outstanding contribution to the advancement of fisheries management while working in Kansas.

**RICHARD L. HAGER, State Information Resources Manager for USDA/SCS.** Richard was born and raised in Montana on the Yellowstone and Boulder Rivers. In 1961, he entered Montana State University in Bozeman. From 1962 to 1966 he was in the U.S. Navy. He returned to Montana State University to receive his B.S. degree in 1970, and in 1972 received his M.S. degree, both degrees were in Biology. From 1972 to 1979, he was an area biologist with the USDA/SCS Missoula, Montana. In 1979 to 1987, Richard was a state biologist with the USDA/SCS in Salina,

**RICHARD R. HANNAN, Director, Kentucky Nature Preserves Commission.** Richard has been the director of the Kentucky State Nature Preserves Commission since 1982. Before becoming director, Richard served as a staff ecologist with the Nature Preserves Commission for four years. Richard has a B.S. in biology and an M.S. in plant ecology from Eastern Kentucky University. His current responsibilities include coordinating the efforts of the Nature Preserves Commission.

**F. ROBERT HENDERSON, Professor and Extension Specialist, Animal Damage Control, Kansas State University, Department of Animal Sciences and Industry.** Bob received his M.S. in 1956 from Fort Hays State University. He then worked on a private hunting preserve from 1956 to 1958. From 1958 to 1960, he served as the first Executive Secretary of the Kansas Wildlife Federation. From 1961 to 1967 he worked as a District Game Manager for the South Dakota Game, Fish, and Parks Department. While there he did research on sharp-tailed grouse and the endangered species, the black-footed ferret. From 1968 to the present time, he has held his current appointment.

**GERALD J. HORAK, Wildlife Research Biologist, Kansas Department of Wildlife and Parks.** Gerald received his B.A. degree in 1962 from St. Ambrose College in Iowa and his M.S. degree in 1964 at Iowa State University in the Wildlife Ecology Program. He worked from 1964 to

1979 as a Prairie Chicken Project Leader conducting statewide habitat and populations surveys. From 1980 to 1990 he was the Waterfowl Project Leader and initiated and supervised the giant Canada goose restoration program in Kansas. In 1991 he became the Threatened and Endangered Program Specialist for Wildlife and Parks.

**HAROLD E. KLAASSEN, Associate Professor, Kansas State University.** Harold grew up on a farm in Kansas. He received his B.A. degree from Tabor College, his M.S. degree from Kansas State University, and Ph.D. degree from the University of Washington. He has been a faculty member in the Division of Biology of Kansas State University since 1967. At K-State, he teaches courses such as Wildlife Conservation, Ichthyology, Herpetology, Fisheries Management, and Aquaculture. Dr. Klaassen has been involved in a variety of fisheries related research, including distribution of stream fishes, reservoir fish distribution, pesticide residues in aquatic systems, farm pond management, and production of channel catfish in ponds for home use. Currently, he is engaged in studies of crayfish aquaculture.

**EDWARD L. KOZICKY, past President of the Wildlife Society, and currently, a visiting scientist at Welder Wildlife Foundation, Sinton, Texas.** In 1983, Ed was a visiting scientist at the Caesar Kleberg Wildlife Research Institute, Texas A & M University, Kingsville, Texas, where he wrote a book, *Hunting Preserves for Sport or Profit*. His refinements of census techniques for game birds while at Iowa State University, 1948 to 1956 have been recognized as an outstanding contribution in the application of statistical procedures to wildlife research and management projects. He served as director of conservation for the Winchester Group, Olin Corporation, from 1956 to 1983. Included in his responsibilities were the direction of Nilo Farms, where he supervised the development of many techniques for the management of game birds on hunting preserves.

**MICHAEL J. LACKI, Assistant Professor, University of Kentucky (UK).** Mike has been on the faculty at UK since 1990. Before coming to UK, Mike was an assistant professor and leader of the wildlife technology program at The Pennsylvania State University, DuBois campus. Mike has also been a visiting assistant professor at the State University of New York at Plattsburg and an instructor at North Carolina State University. Mike has a B.S. in biology from the University of Dayton. He has an M.S. in zoology and wildlife biology from Ohio State University and a Ph.D. from North Carolina State University. His current responsi-

---

bilities include directing the teaching and research wildlife biology program at UK. Mike's current research interests include examining wildlife habitat in the context of biogeographic principles.

**CHARLES D. LEE, Agricultural Liaison Biologist, Kansas Department of Wildlife and Parks.** Charles received a B.S. in Fisheries and Wildlife Biology from Kansas State University in 1975. After being involved in the family farm and ranch operations, he returned to KSU for graduate school. He received an M.S. in Animal Science in 1988, with a thesis project on control of starling damage at Kansas feedlots. Charles currently coordinates many of Kansas Department of Wildlife and Parks' private land programs including the Wildlife Habitat Improvement Program, Wetlands and Riparian Areas Project, Animal Damage Control, and serves as liaison to USDA agencies concerning wildlife management on private lands.

**ROBERT M. MORTON, Area Supervisor, Sloughs Wildlife Management Area (WMA), Kentucky Department of Fish and Wildlife Resources.** Robert has been the area supervisor at Sloughs WMA for 10 years. Before becoming an area supervisor, Robert was a wildlife biologist with the KDFWR for four years, working in north-central and southeastern Kentucky. He has an associate degree in science from Henderson Community College and a B.S. in wildlife biology from Murray State University. His current responsibilities include planning, supervising, and reporting on all the activities conducted on the 10,500-acre Sloughs WMA.

**LEE K. NELSON, private consultant, Owensboro, Kentucky.** Lee was a wildlife biologist with the KDFWR from 1950 until he retired in 1987. He held a variety of positions with the department, including ring-necked pheasant project leader, chief of the wildlife research section, district wildlife biologist, and land-acquisition coordinator. He has a B.S. in biology and an M.S. in wildlife management from Michigan State University. Lee is an honorary member of the Organization of Lands and Realty Specialists and the Kentucky Chapter of the Wildlife Society.

**PAUL D. OHLENBUSCH, Associate Professor of Range Science and Extension Specialist, Range and Pasture Management, Department of Agronomy, Kansas State University.** Paul received his B.S. degree in 1963 from Southwest Texas State University. He received his M.S. and Ph.D. degree from Texas A & M University in 1966 and 1975 respectively. From 1965 to 1968 he served as

County Extension Agent Chairman, University of Nebraska Cooperative Extension Service. From 1968 to 1975 he served as research associate and Graduate Research Assistant, Range Science Department, Texas A & M University. From 1975 to the present he serves as Associate Professor of Range Science and Extension Specialist, Range and Pasture Management, Department of Agronomy, Kansas State University.

**RICHARD OLSON, Assistant Professor and Rangeland Wildlife Habitat Extension Specialist, Department of Range Management, University of Wyoming.** Richard has extensive professional experience in waterfowl, upland game bird, and big game habitat management. He has worked as a Wildlife Habitat Biologist for 10 years with the Wyoming Game and Fish Department before transferring to the University of Wyoming. He is a Certified Wildlife Biologist with The Wildlife Society. Research interests focus on wildlife/livestock habitat enhancement, rangeland wetland/riparian ecology, and wildlife habitat evaluation. At the University of Wyoming, he teaches a course in Rangeland Vegetation Management. He received a Ph.D. from North Dakota State University (1979) in Range Management/Wetland Ecology, an M.S. from South Dakota State University (1975) in Wildlife Biology/Plant Ecology, and a B.S. from the University of Wisconsin (1970) in Journalism.

**JAMES L. PEASE, Assistant Professor and Extension Wildlife Specialist, Department of Animal Ecology, Iowa State University (ISU).** Jim has a broad background in education, natural resources, wildlife and camping. He currently teaches interpretation and directs his efforts in Extension wildlife education. In addition, he advises State 4-H Staff at ISU on Extension camping and environmental education, a program he directed for nine years. He has authored and co-authored many state and national publications for Extension, including publications on managing Iowa wildlife, the 4-H Ding Darling school enrichment project and the nationally popular *Birds, Beasts, Bugs, and Us*, a collection of hands-on environmental activities used at camps and schools. His creative, high-involvement teaching techniques are some of those featured on a nationally released series of video tapes, *Teaching Natural Resources*.

**JOHN H. PHILLIPS, Deer Program Coordinator, Kentucky Department of Fish and Wildlife Resources.** John has been the deer program coordinator for the KDFWR since 1978. Before taking that position, John worked as a district wildlife biologist and wildlife manager with the KDFWR for four years. He has a B.S. and an M.S. in wildlife biology from Eastern Kentucky University. His

---

current responsibilities include coordinating white-tailed deer research and management efforts throughout the state.

**JEFF POWELL, Professor, Department of Range Management, University of Wyoming.** Jeff has extensive professional experience in ranch management and ranch recreation. He is a certified range management consultant with specialization in the areas of ranch recreation business, ranch management planning, rangeland nonpoint pollution problems from cattle grazing, and environmental impact assessment. Research interests focus on livestock-wildlife interrelationships and livestock-wildlife habitat improvement. At the University of Wyoming, he teaches courses in Range Inventory and Management Planning, Rangeland Forage Quality, and International Range Management. He received a Ph.D. from Colorado State University (1968) in Range Ecology/Nutrition, an M.S. from Texas Tech University (1966) in Range Science/Animal Science/Wildlife, and a B.S. from Oregon State University (1964) in Range Management/Animal Science.

**RONALD D. PRITCHERT, JR., Waterfowl Program Coordinator, Kentucky Department of Fish and Wildlife Resources.** Ron has been the waterfowl program coordinator for the KDFWR since January 1990. Before coming to Kentucky, he was a waterfowl biologist with the U.S. Fish and Wildlife Service's National Wetlands Center in Louisiana for two years. He also gained wildlife biology expertise working for Southern Illinois University. He has an associate degree in biology from Waubensee Community College and a B.S. and an M.S. in zoology from Southern Illinois University. His current responsibilities include coordinating all activities associated with waterfowl management in the state. He is also Kentucky's representative to the Mississippi Flyway Council.

**RANDY RODGERS, Wildlife Research Biologist working with upland game for the Kansas Department of Wildlife and Parks.** Randy is a native Kansan and earned his B.S. degree in wildlife biology from Kansas State University in 1975. He completed his M.S. at the University of Wisconsin at Madison and began work in Kansas in early 1979. Randy initiated and coordinated restoration programs for both ruffed grouse and sharp-tailed grouse in Kansas. His specialty is the effects of certain agricultural practices on wildlife. In particular, he has focused on changes in wheat cropping practices on the High Plains and the associated decline in pheasant populations.

**ROBERT D. SMITH, Extension Wildlife Associate, University of Tennessee.** Bob has been an assistant wildlife

associate with the University of Tennessee Extension Service since 1990. Before working with Extension, Bob was a wildlife biologist at the Land Between the Lakes (LBL) for 23 years. He has also worked for the Tennessee Wildlife Resources Agency as a district game biologist and assistant chief before working at LBL. Bob has a B.S. in biology and agriculture from Western Kentucky University. His M.S. in wildlife management is from Louisiana State University. His current responsibilities include providing wildlife information to Extension clientele in western Tennessee.

**JEFFERY D. SOLE, Upland Game Program Coordinator, Kentucky Department of Fish and Wildlife Resources.** Jeff has been upland game program coordinator with the KDFWR since 1986. Before taking that position, Jeff worked as a wildlife biologist and environmental specialist with the KDFWR for five years. He has also worked as a botanist with the Kentucky Nature Preserves Commission. Jeff has a B.S. in wildlife management and an M.S. in biology from Eastern Kentucky University. His current responsibilities include conducting research and implementing programs to manage and monitor small game populations across the state.

**ELIZABETH R. STINSON, Research Wildlife Biologist with the Virginia Department of Game and Inland Fisheries, stationed in Blacksburg, Virginia.** Among Elizabeth's responsibilities for the department, she conducts reviews of pesticide impacts on wildlife. She completed her master's research on pesticide effects on quail, using laboratory studies combined with analysis of pesticide residues in wings returned by hunters. Her masters was granted in 1988 from the Department of Fisheries and Wildlife Sciences, Virginia Polytechnic Institute and State University.

**DALE STRICKLAND, co-owner and Vice President and Senior Ecologist for Western EcoSystems Technology, Inc. (WEST) in Cheyenne, Wyoming.** Dale has over 20 years of experience in wildlife research and management. His research experience includes applied research on large and small mammals, birds, reptiles, and amphibians and habitat. He has had extensive involvement in research and management of game, nongame, and endangered and threatened species. Dale is a graduate of the University of Wyoming with a Ph.D. in ecology and is presently an Adjunct Professor in the Department of Statistics at Wyoming. He is author of over 50 scientific and popular papers regarding wildlife ecology, wetlands and threatened and endangered species. Prior to founding WEST, Dale was

---

employed by the Wyoming Game and Fish Department for over 16 years. While with the Department, he was a wildlife biologist and administrator. He served as Assistant Chief of the Wildlife Division for seven years. Dale is currently involved in research on wildlife and wetlands throughout the United States.

**GERALD (Jerry) W. TOMANEK, was a Professor of Biology at Fort Hays State University for 40 years (1947-87) and served as President during the last 12 years.** Jerry taught a wide variety of courses in the areas of grassland ecology, conservation and field biology. He directed grassland research projects on prairies of western Kansas and has numerous publications in scientific journals and books. He has received many awards and was named “Kansan of the Year” in 1978 but feels his greatest award (reward) is the success of hundreds of his former students.

**LEE WOLLRAB, Idaho Department of Fish and Game.** Lee began working as a Biologist Aide for the Wyoming Game and Fish Department in 1982. He was promoted to a Wildlife Biologist in Pinedale in 1986, where contributions included big game herd unit management, deer mortality and elk habitat-use research, mitigation for losses of big game habitat as a result of oil and gas developments, land-use planning efforts with federal agencies, and public relations.

After moving to Idaho in 1993, Lee started promoting nongame and Watchable Wildlife programs as a Technician in the Southwest Region of the Idaho Department of Fish and Game. Recent work includes drafting a Watchable Wildlife plan, mitigation efforts with local planners to protect Bald Eagles wintering on the Boise River, and community involvement to promote Kuna, Idaho as the Gateway Community to the BLM Snake River Birds of Prey National Conservation Area.

**GEORGE WRIGHT, Turkey Program Coordinator, Kentucky Department of Fish and Wildlife Resources.** George has been the KDFWR turkey program coordinator since 1984. Previously, George worked on turkey management for 10 years with the KDFWR as a district biologist and a wildlife biologist. He has a B.S. in wildlife management from Tennessee Tech University and an M.S. in wildlife management from Auburn University. His current responsibilities include conducting turkey research and reintroductions and implementing programs geared to monitoring and managing the turkey population throughout Kentucky.



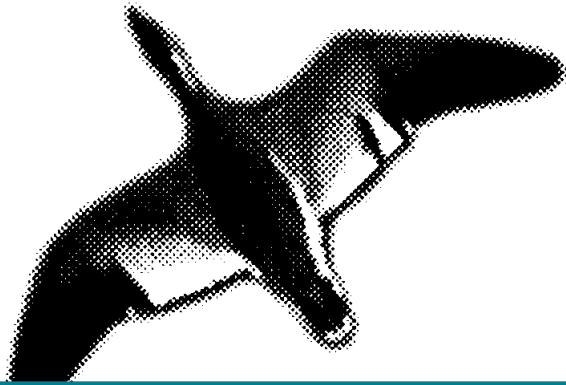

PRIVATE  
LANDS

SECTION I

UNDERSTANDING HOW  
THE SYSTEM WORKS

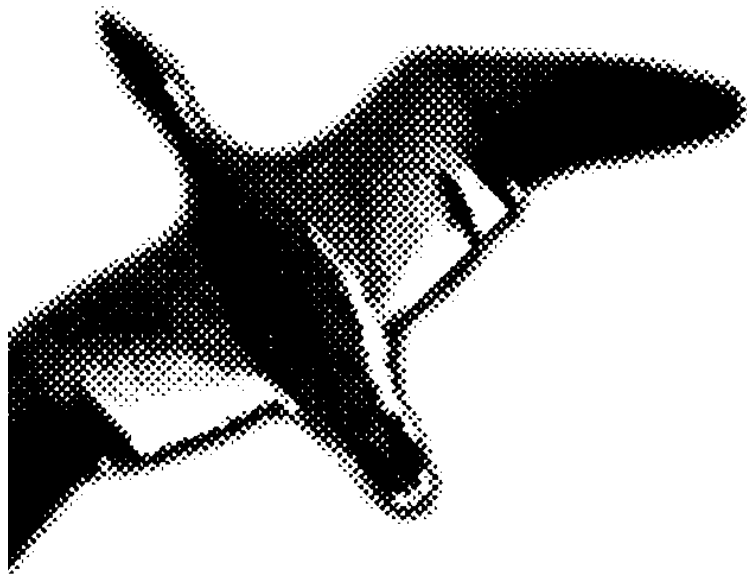

WILDLIFE  
MANAGEMENT

A Technical Manual  
&  
Correspondence  
Course



## Chapter 1

# Introduction: What Are Wildlife and Wildlife Management?

*Thomas G. Barnes*

**W**ildlife means different things to different people. To a backyard bird feeder, it may mean chickadees, nuthatches, and cardinals. To a hunter, it may mean white-tailed deer, bobwhite quail, and fox squirrels. To a sheep producer, it may mean coyotes. To a poultry producer, it may mean mink, weasels, skunks, and raccoons. To a gardener, it may mean hummingbirds and butterflies.

### *What is Wildlife?*

It is important to identify and define what we mean by the term “wildlife” before we can answer the question, “What are wildlife management and conservation?” Early definitions of wildlife focused on wild animals (undomesticated free-ranging animals) that could be hunted for sport or food (game animals are listed in Table 1). Thus, the early definitions restricted the term wildlife to **vertebrates** (animals with a backbone). From that time forward, the message has been clear: there is a separation of those organisms termed wildlife, not only from other vertebrates, but most certainly from other groups of lower animals and plants.

If you were to ask a professional biologist to define wildlife, he/she would probably identify two distinct vertebrate groups: birds and mammals. Some states and federal organizations, in their names, make a distinction between fish and wildlife such as the Kansas Department of Wildlife and Parks and the United States Fish and Wildlife Service.

Much has happened in the field of wildlife science since early times (see Chapter 2), and this is reflected in new definitions of wildlife based on a more holistic viewpoint. The beginnings of this new viewpoint of wildlife began in the 1960s. Wording in the Endangered Species Act of 1973 recognized fish and wildlife as any member of the animal kingdom, including without limitation any mammal, bird, fish, amphibian, reptile, mollusk, crustacean, arthropod, or other **invertebrate** (animal without a backbone).

About the same time, many states began adopting nongame wildlife programs. These programs were aimed at managing protected, endangered or threatened, and nonhunted wildlife with respect to the definition of fish and wildlife provided in the Endangered Species Act.

From a purely objective standpoint, wildlife should include all animals and their associated habitats. If we are to

look at the big picture, it seems unnecessary to define the term wildlife along the usually rigid and nonfunctional lines of a **taxonomist** (a person who identifies and classifies living organisms).

How can we understand the ecology of a great blue heron without a thorough knowledge of the heron’s food source (small minnows, amphibians, etc.)? Likewise, a picture of coyote ecology would be incomplete without an understanding of how that animal’s diet shifts from small mammals and carrion in the winter, to insects and fruits during the summer. Further, the relationship of an animal to its habitat (including competitors, predators, prey items, vegetation, and soil) is so interconnected as to add confusion in attempts to restrict the term wildlife.

Thus, a definition of wildlife should include all living organisms out of the direct control of man, including undomesticated or cultivated plants and animals.

Although it may be inappropriate to restrict wildlife to a few kinds of organisms, common usage, public perceptions, funding allocations, and history have resulted in a practical definition of wildlife as undomesticated free-ranging vertebrates. Furthermore, because of professional distinctions, fish are generally excluded from the definition of wildlife. Thus, the definition of wildlife is left as essentially undomesticated, free-ranging terrestrial vertebrates (reptiles, amphibians, birds, and mammals).

The overwhelming preponderance of research and management efforts, as well as public attention, has caused the definition of wildlife to focus on birds and mammals.

There is yet another dilemma for resource managers in defining wildlife today: introduced, nonnative wildlife or exotics, such as the European starling, house sparrow, wild boar, and fallow deer. Hundreds of plants, fish, and terrestrial animals have been introduced into this country, some by accident and others on purpose.

To the wildlife biologist, exotics may have severe consequences for native wildlife (starlings and house sparrows competing for eastern bluebird nesting sites). They may be considered successful (ring-necked pheasant) or a passing fad.

Professional biologists will debate the pros and cons of exotic introductions for years to come. Regardless of an individual’s views on the subject, certain exotics will continue to be a permanent addition to our natural communities. Professional biologists must continue to evaluate the

**Table 1. Partial listing of Wildlife Species in the United States.**

<b>Upland Game Animals</b>	<b>Waterfowl</b>
Wild Turkey (K)	Sandhill Crane (K)
Ruffed Grouse (K)	Greater White-fronted Goose (K)
Spruce Grouse	Canada Goose (K)
Blue Grouse	Brant (K)
Sharp-tailed Grouse (K)	Snow Goose (K)
Sage Grouse	Mallard (K)
Greater Prairie Chicken (K)	Black Duck (K)
Rock Ptarmigan	Mottled Duck (K)
Willow Ptarmigan	Gadwall (K)
Northern Bobwhite (K)	American Widgeon (K)
Scaled Quail (K)	Green-winged Teal (K)
California Quail	Cinnamon Teal (K)
Mountain Quail	Blue-winged Teal (K)
Chukar (I,K)	Northern Pintail (K)
Ring-necked Pheasant (I,K)	Northern Shoveler (K)
Gray Partridge (I)	Ruddy Duck (K)
Mourning Dove (K)	Wood Duck (K)
White-winged Dove	Canvasback (K)
American Woodcock (K)	Redhead (K)
Common Snipe (K)	Ring-necked Duck (K)
Cottontail Rabbit (K)	Lesser Scaup (K)
Swamp Rabbit	Greater Scaup (K)
Eastern Cottontail (K)	Common Goldeneye (K)
Black-tailed Jackrabbit (K)	Bufflehead (K)
White-tailed Jackrabbit	Hooded Merganser (K)
Woodchuck (K)	Common Merganser (K)
Fox Squirrel (K)	American Coot (K)
Eastern Gray Squirrel (K)	
Snowshoe Hare	

<b>Big Game Mammals</b>	<b>Furbearing Mammals</b>
White-tailed Deer (K)	Coyote (K)
Fallow Deer (I)	Red Fox (K)
Mule Deer (K)	Gray Fox (K)
Elk (K)	Arctic Fox
Moose	Raccoon (K)
Black Bear (K)	Bobcat (K)
Caribou	Lynx
Dall Sheep	Beaver (K)
Bighorn Sheep	Spotted Skunk (K)
Mountain Goat	Striped Skunk (K)
Pronghorn Antelope (K)	Opossum (K)
American Bison (K)	Least Weasel (K)
Mountain Lion (K)	Long-tailed Weasel (K)
Wild Hog (I)	Short-tailed Weasel
Javelina	Mink (K)
	Badger (K)
	Fisher
	Marten
	Wolverine
	Muskrat (K)
	Nutria (I)

*(K) indicates the species occurs in Kansas.  
(I) indicates the species was introduced into this country.*

ecological role of exotics in biological communities. Hence, if exotics are free-ranging, little is gained from excluding them from a definition of wildlife.

**What is Wildlife Management?**

Now on to the question, “What is wildlife management?” The definitions of wildlife management are about as numerous as authors and professional biologists. There are some differences, to be sure, but three common ideas are present in every definition of wildlife management, including:

- 1) efforts directed toward wild animal populations,
- 2) relationship of habitat to those wild animal populations, and
- 3) manipulations of habitats or populations that are done to meet some specified human goal.

Early wildlife biologists viewed wildlife management as the art of making the land produce adequate game for recreational use (hunting, fishing, or trapping). Later definitions emphasized wildlife management as the science of manipulating wild animal populations and their habitats for specific human goals. Current definitions stress wildlife management as applied animal ecology that benefits the habitat and both the wildlife and human populations.

Wildlife management can be a complex process (Figure 1) whereby a landowner or biologist:

- conducts habitat and wildlife population inventories and evaluations; and
- determines what the people desire from the wildlife resource and superimposes human goals on the natural system based on initial inventories and evaluations.

The eventual outcome in meeting desired management goals is accomplished by:

- 1) manipulating the habitat,
- 2) manipulating the animal population, or
- 3) managing the people.

Wildlife management on private lands is largely habitat management for two reasons:

- most private landowners do not control the kind of acreage (average farm size in Kansas is about 700 acres) necessary to totally sustain some wildlife populations (e.g., approximately 1,000 acres are required to manage white-tailed deer populations); and
- private landowners do not have to consider the political and public ramifications of management decisions (as state and federal agencies do).

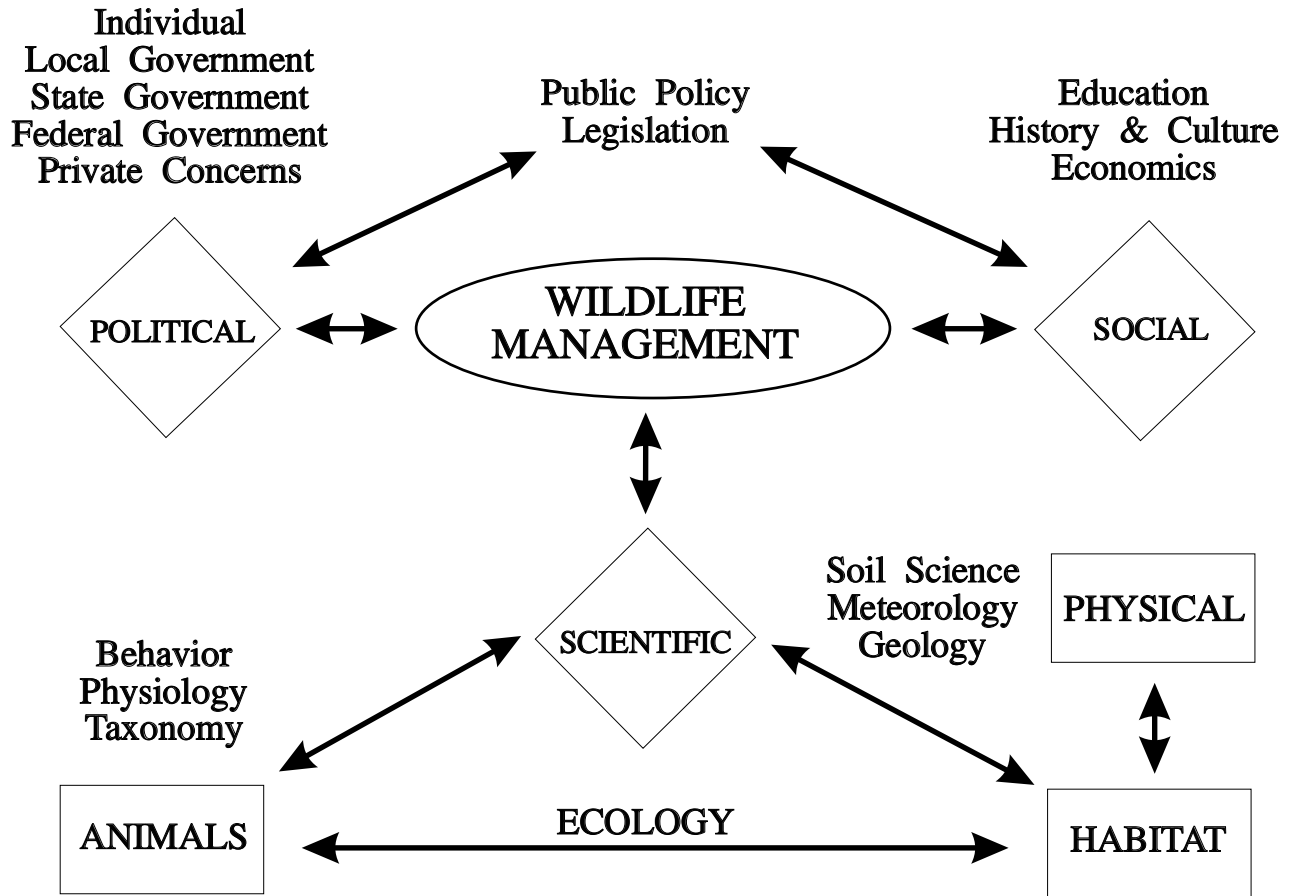

Figure 1

**Preservation, Conservation, and Management:  
What is the Difference?**

We should now examine the differences between management, conservation, and preservation because many people mistakenly confuse wildlife management with wildlife preservation (Figure 2).

**Conservation** is an effort to maintain and use natural resources wisely in an attempt to ensure that those resources will be available for future generations. Thus, wise use of resources could vary from actively managing white-tailed deer populations by hunting to protecting and preserving Neosho madtom populations and habitat.

**Preservation** is a component or part of conservation in which natural systems are left alone without human disturbance or manipulation. Preservationists (people who believe in preservation) feel natural resources should be protected, unspoiled, and untouched by humans. The goal of preservation is often maintaining the integrity of the ecosystem as exemplified by nature preserves or wilderness areas.

**Passive management strategy** is sometimes used in wildlife management when animal populations dwindle to

the point they are in danger of extinction. The passive management strategy for a state-listed threatened species in Kansas is not to allow harvesting.

It is important to note, however, that an undisturbed ecosystem is not necessarily a stable one. Natural changes in the plant community (see Chapter 3) constantly create different habitats for different species of wildlife. Thus, as the system changes over time, conditions may not remain suitable for the continued existence of some wildlife species in that community.

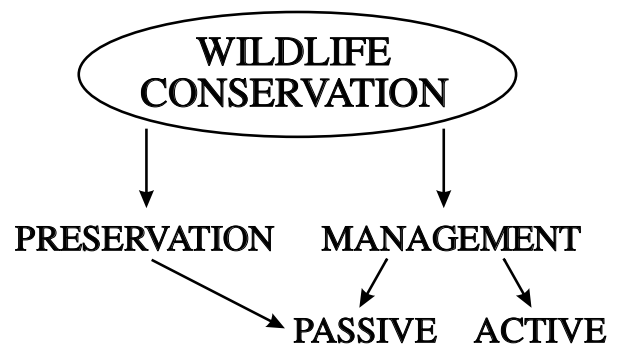

Figure 2

As a grassland is allowed to mature after having once been cropped, the presence and abundance of ring-necked pheasants will decline because the habitat is no longer suitable for them.

**Management** is also a component of conservation that usually means controlling, directing, or manipulating wildlife populations and/or their habitats (active management strategy). Wildlife managers usually seek to:

- 1) increase a population (by planting food and cover plots for quail or monitoring livestock grazing pressure for many species);
- 2) decrease a population (by harvesting deer when they are damaging orchard trees or soybean crops); or
- 3) stabilize a population so that individuals can be removed on a continuing basis, making sure that enough individuals remain in the population to replace those that are removed (**sustained yield**).

There are two different approaches to managing wildlife. The first approach is to provide as varied a habitat as possible in an attempt to support as many different wildlife populations as possible. This is called the **species richness approach** to managing wildlife. Under this system, a landowner would try to manage his property to provide a mixture of areas in different plant stages (Chapter 3), areas with large amounts of edge interspersed with some unbroken tracts of forest, and forested areas with vertical layering of trees, shrubs, and broadleaf weeds.

The second approach to managing wildlife is called the **featured species approach**. The goal of this approach is to provide habitat for one selected (featured) species. Thus, a landowner might choose to manage for white-tailed deer or bobwhite quail exclusively. The key to featured species wildlife management is to identify the precise habitat requirements of the featured species and select management practices that provide the requirements that are in the shortest supply.



*Coyotes can be found in every Kansas county. A complete understanding of coyote biology cannot be achieved without understanding the relationship of coyotes to their habitat.*



*Endangered species like Grey Myotis bats need protection from adverse human disturbance and destruction of woody stream corridors.*



*White-tailed deer are classified as wildlife because they are an undomesticated, free-ranging vertebrate. Kansas has more white-tailed deer today than when pioneers crossed the state because of changing land-use patterns and sound scientific management.*



*With the passage of the Endangered Species Act of 1973 and changing public attitudes, invertebrates such as this butterfly are now included in the term wildlife.*



*The killdeer is considered a nongame wildlife species because it is not hunted.*



*Ring-necked pheasant is an exotic that is widely believed to be native to Kansas.*



## Questions for Chapter 1

1. What types of animals are considered wildlife?
2. What three components must be present in any definition of wildlife management?
3. Wildlife management is a complex process. Describe how the scientific, political, and social arenas affect the decision-making process.
4. What is the difference between conservation, preservation, and management?

### Questions for Chapter 1 (continued)

5. What are the three desired outcomes of an active management strategy?

6. What is the difference between the species richness approach and the featured species approach to wildlife management?

Name \_\_\_\_\_



## Chapter 2

# Where Are We Now and How Did We Get There? A Lesson from History and Wildlife Legislation

*Lee K. Nelson*

Even though man's relationship with the rest of the natural world extends backward some 250,000 years, it is the recent past that we must understand if we are to comprehend what is occurring today.

Actions taken in the past largely reflected the conditions prevalent at the time. For example, very little thought was given to increasing wildlife numbers in past centuries because many species were in abundant supply. When those supplies started to dwindle, efforts were begun to regulate the killing of some animals. As scarcity became more acute, regulations were tightened, studies were begun on how to restore the populations, and habitat management was undertaken to maintain or increase population levels. As some species approached extinction, drastic measures were sometimes taken to save them.

All of these actions were unforeseen and probably unbelievable when they happened. Only by examining history are the events placed in proper perspective. This chapter will convey a sense of where we have been and how we can use this information to guide us in future efforts while avoiding past failures and expanding on past successes.

Tribal taboos involving the taking of animals date back to the beginning of human history. One of the earliest recorded points in the history of wildlife management was when an early Roman emperor recognized the right of a landowner to forbid another from killing game on his property. The first record of a system of game management for conservation purposes comes from the Mongol Empire in Asia during the 13th century. This system prohibited the taking of specified game animals from March through October. In addition, millet and other grains were planted along the sides of valleys as a source of food and shelter for game birds. This is perhaps the earliest known instance of manipulating food and cover specifically to benefit wildlife.

### *How We Learned from the Europeans*

Wildlife management in the United States has been influenced greatly by laws, policies, and traditions established in western Europe. During the time of Robin Hood in feudal Europe, only royalty or the ruling class could use wildlife in any way. Wildlife management did not include the control of food or cover; rather, it was based on the customs and traditions of royalty that included

protecting breeding waterfowl (ducks, geese, and swans) and herons and attempting to control or exterminate predators. During this time, a season was set on red deer (similar to the elk in North America), and the familiar tradition of killing only male deer was established.

Weapon restrictions date to the 15th century under the rule of Henry VII, and a bounty system to control predators was attributed to Henry VIII. Artificially rearing game for restocking purposes was thought to have begun as early as 1523. Hunting reservations for the privileged date back to the 11th century, and the setting aside of parks and forests was well-established in England by the 1600s. James I applied the reservation idea for the benefit of game in the 17th century, and the first breeding refuge for nongame birds was decreed by the British Parliament in 1869.

Perhaps the most important wildlife tradition from Europe was provided by the signing of the Magna Carta in 1215. With that document, the ownership of wildlife was transferred from the Crown (royalty) to the people. This document provided the basic tenet that wildlife is public property which is tended by the government as a sacred trust. This law laid a foundation for wildlife management in this country.

### *Wildlife Management in America*

#### **Period of Endless Supply**

Hunting controls played a large part in the history of American wildlife management. Initially, it was assumed the supply of wildlife was inexhaustible. This assumption was based on observations of buffalo herds stretching as far as the eye could see and flocks of birds, such as passenger pigeons, that darkened the sky from horizon to horizon. This period of American wildlife history has been coined the "period of abundance" when wildlife were treated as though they would always be in endless supply.

The same was true for wildlife habitat encompassing vast acreages of pristine forests, prairies, and mountains. Change came when increasing numbers of humans set out to conquer the wilderness with axe, saw, plow, fire, and livestock. Later they used mechanized equipment, such as the chain saw, bulldozer, and drag line, that impinged on wildlife habitat.

### Period of Exploration and Exploitation

During the “period of exploitation” in Kansas, the legendary prairie grasslands were cut to the few thousand acres that remain today in isolated patches too rocky to plow. And, grassland wildlife species, such as prairie chickens and buffalo, were immediately affected when the prairie was plowed. Some of the cleared ground initially provided a source of food for many species of wildlife including prairie chickens and waterfowl as the land was planted to corn and other grains. However, when the practice of plowing under the crop stubble in the fall became widespread, this benefit was lost or severely diminished. Ducks and other water birds were forced to seek less desirable nesting and migration habitat elsewhere as wetlands were drained and plowed, and their numbers were greatly reduced.

When forests were cleared for self-sustaining, family farms, some wildlife species, such as the bobwhite quail and cottontail rabbits, benefitted. However, as small farms were assimilated into large, corporate farms and managed on almost a monocultural basis with few, if any, fencerows, bobwhite quail and cottontail populations plummeted.

As if habitat destruction was not causing enough problems for wildlife, the culinary delight that some game species (passenger pigeons, buffalo, waterfowl, prairie chickens, etc.) provided had telling effects. Commercial hunting for the market was aided by the development of more efficient firearms, the opening of railroad routes, and the arrival of the refrigerated rail car. Consequently, some wildlife species could not bear the added pressure and became scarce.

The federal Lacey Act of 1900 prohibited interstate sale of wild game taken in violation of state law. This, along with greatly reduced game populations, terminated market (or commercial) hunting and the decimation of wildlife for profit.

### Period of Preservation

Fortunately there were individuals who looked beyond the present and realized controls were necessary to ensure the continued survival of various wildlife species. During this “period of preservation,” America was trying to perpetuate the resources that remained, and game laws were designed to regulate the taking of the dwindling supply (Table 1). Wildlife management emphasized the prohibition of market hunting and developed laws to protect wildlife. As early as 1677 Connecticut began regulating hunting seasons and prohibited the export of game, hides, and skins. By 1700, all of the original colonies except Georgia established a season to protect white-tailed deer. Virginia enacted legislation in 1775 to outlaw “fire hunting” (use of fire to flush animals so they could be killed more easily), and the killing of deer for hides only.

It does little good to protect wildlife without having public officials to enforce the laws. Thus, in 1850 the game warden system began in New Hampshire. Because these wardens were not paid, enforcement was a problem. Several years later the first salaried game warden was hired in Maine.

As the “period of preservation” advanced, a major step in American conservation occurred in 1872 when Yellowstone National Park was created as the world’s first national park. The park was originally established for its fantastic wildlife populations, spectacular scenery, and interesting geothermal activities. The park became our first wildlife reserve when it was closed to hunting in 1894.

### Period of Conservation: A Turn of the Tide

These activities set the stage for the “period of conservation” introduced by our 25th president, Theodore Roosevelt. Roosevelt had a great interest in this country’s natural resources and conceived the idea of “conservation through wise use.” His idea was that renewable resources might last forever if they could be harvested scientifically and not at a faster rate than they could reproduce. Roosevelt’s Doctrine of Conservation, based on these ideas, recognized outdoor resources as one integral whole. It also declared that conservation through wise use was a public responsibility, and science was the tool for discharging that responsibility. During the period of conservation, Roosevelt took measures to:

- *ensure that the Lacey Act was enforced strictly;*
- *create the first federal bird refuge at Pelican Island, Florida, which became the precursor of our National Wildlife Refuge System;*
- *create 23 national monuments;*
- *expand and improve the number of national parks; and*
- *beef up the newly created Division of Forestry by setting aside 148 million acres on national forest lands.*

Another notable federal action during this period came in August 1916 with the signing of the Migratory Bird Treaty Act with Canada and Great Britain. This agreement established broad parameters for hunting migratory game birds (ducks, geese, and swans) and prohibited killing songbirds and several nongame birds. Congress provided legislative teeth for the treaty in July 1918 with the addition of legal penalties to the original treaty.

The United States and Mexico signed a similar treaty in February 1936, and thereafter the rules set forth applied to all of North America. Protection was given to 32 additional families of migratory birds in March 1972.

The period of conservation began in Kansas in 1876 when the Kansas Governor appointed D. B. Long to be the first director of Kansas Fish Department. A few laws were passed to protect fish. In the early 1890s fish wardens were appointed by the Governor; however, these wardens received no pay, only the constable fee in case of a conviction. Consequently, many of them did not protect fish

to their full ability. In 1903, Long had 3,000 imported Chinese ring-necked pheasants released in different parts of the state. A railroad coach car was purchased for fish distribution. This car released fish into streams and rivers of the state from railroad bridges. Soon, money was available from the legislature to build a fish hatchery and game farms. In 1914 the Governor appointed a commission of five sportsmen from various parts of the state. They worked without pay and met twice yearly to discuss laws and matters pertaining to the protection, propagation, and distribution of fish and game in Kansas. As the people of Kansas became aware of the facts and looked at the future of conservation, they began to give the department the support it needed to further its work.

### **Period of Game Management and Restoration: The Emergence of Modern Wildlife Management**

The most significant events affecting wildlife conservation in the United States began around 1930 and ushered in the “period of game management.” When Aldo Leopold wrote his classic text *Game Management* in 1933, this event signaled the birth of professional wildlife management.

The management of wildlife was largely confined to game species because the leaders behind the movement were mainly sportsmen, and their license fees were the primary (sometimes the only) support for wildlife programs. During this period, officials realized that protection of wildlife alone was insufficient for increasing populations. They realized that biological research on the habits and habitats of wildlife was lacking and that efforts should be directed toward providing the proper habitat (food, cover, and water) for various wildlife species if they were to prosper.

The most notable contributions of this period were:

- *increased funding for wildlife conservation;*
- *the beginning of effective conservation administration;*
- *increased information on the biology, natural history, and management of wildlife species; and*
- *increased federal involvement in the management of wildlife.*

The most important piece of legislation affecting wildlife management in the United States took place in 1937. This benchmark piece of legislation set the stage for modern wildlife management programs. The United States Congress passed the Pittman-Robertson (P-R) Act, which levied an 11 percent excise tax on the sale of firearms, ammunition, and related equipment. A portion of the tax (8 percent) was retained for operating the program, and the rest was returned to individual states based on:

- 1) *total population of the state,*
- 2) *the number of paid license holders in the state, and*
- 3) *land area encompassed.*

Under this system, no state can receive less than one-half of 1 percent or more than 5 percent of the funds. States can use the money for hunter education programs, wildlife research projects, selection and purchase of wildlife habitat, restoration or rehabilitation of wildlife populations, and various habitat management projects. The P-R Act provided the necessary funding for approved programs and studies and implemented a biological approach to wildlife management.

A demand for a qualified work force was created, and the nation’s colleges and universities responded. Federal control of P-R expenditures and programs in each state was rigidly exercised. One of the major benefits was to lift many conservation agencies out of the political mire. The soundness of the scientific approach was a significant step in establishing credible state fish and wildlife agencies.

The importance of this act cannot be understated. It provided the funding for:

- 1) *training manpower in the field of scientific wildlife management;*
- 2) *essential life-history and habitat studies on wildlife;*
- 3) *developing and implementing population surveys;*
- 4) *restoring decimated species, including white-tailed deer, ruffed grouse, wild turkeys, and river otters;*
- 5) *procuring equipment necessary to achieve habitat management programs;*
- 6) *instituting hunter education programs; and*
- 7) *developing wildlife management programs targeted for private landowners.*

Throughout the history of wildlife conservation, the burden for financing programs and activities has fallen on the hunting public, and this era was no exception. Legislation passed during this period required waterfowl hunters to purchase a stamp before they could hunt ducks, geese, or swans (Migratory Bird Hunting Stamp Act or Duck Stamp Act). The funds raised from the sale of Duck Stamps were earmarked for procuring and developing waterfowl production areas and migratory bird refuges.

Thus, sportsmen were again responsible for saving and managing valuable wetland and associated upland habitats required by a variety of game and nongame wildlife species. This action was expanded in 1961 when Congress passed the Accelerated Wetlands Acquisition Act. This act created a fund to help purchase wetlands with monies to be repaid by future Duck Stamp sales.

Other acts of Congress provided protection for bald eagles in 1940, the golden eagle in 1962, and certain endangered species in 1966, 1969, 1973, 1977, and 1988. Falconry regulations were added to the Migratory Bird Treaty in 1976.

In the mid and late 1930s, the Kansas Fish and Game Department began to flourish. Trees were planted, dams were constructed, and water was impounded to form state

lakes and parks. The number and scope of activities and programs increased greatly, including a monthly publication, which was made available to the public.

Wildlife life-history and habitat studies were conducted on many species, including prairie chickens, deer, and waterfowl. These studies were the forerunners to reestablishing white-tailed deer and turkeys throughout the state.

In 1987, the Kansas Fish and Game Commission was merged with the Kansas Parks and Resources Authority to form the Kansas Department of Wildlife and Parks. This change known as Executive Reorganization Order (ERO) No. 22 provided for the Secretary of the department to be appointed by the Governor. The ERO also provided for a seven member Wildlife and Parks Commission with authority to review rules and regulations issued by the department and to serve in an advisory role to the Governor and the Secretary of the department. At this time, the department had 410 full-time employees with a budget of \$30 million. Development activities on public and private lands included:

- distributing trees, shrubs, and forbs to landowners,
- seeding native grasses,
- creating waterfowl refuges and public hunting areas,
- providing technical assistance to farmers and ranchers, and
- providing funds to implement recommended wildlife management practices.

Surveys were developed and conducted to gather data on population levels and trends for most of the game animals so as to control the harvest of these species within their biological surplus.

### Period of Public Environmental Awareness and Management

Today we are in the “period of environmental awareness and management,” which began in the late 1960s. During this period legislation was enacted to:

- *preserve pristine areas as wilderness (Wilderness Act of 1964);*
- establish the Council on Environmental Quality, the Environmental Protection Agency, and the required environmental impact statements (National Environmental Policy Act of 1969);
- protect marine mammals (Marine Mammal Protection Act of 1972);
- protect endangered species (Endangered Species Act of 1973);
- regulate pesticide use (Federal Environmental Protection and Control Act); and
- preserve large amounts of Alaska in national parks, monuments, and refuges (Alaska National Interest Lands Act of 1980).

The increased concern about our environment is also shaping farming practices in Kansas and the United States. The 1985 Food Security Act (Farm Bill) included several provisions with potential benefits for wildlife. Among these were:

- 1) *the “sod buster” component to reduce the amount of highly erodible soil being placed into agricultural production,*
- 2) *the ten-year set-aside program (Conservation Reserve Program/CRP) to establish permanent cover on previous highly erodible croplands,*
- 3) *the “swamp buster” provision to reduce the number of valuable wetland habitats from drainage, filling, or destruction, and*
- 4) *“conservation compliance,” which ensures that an adequate conservation plan is in place for highly erodible croplands.*

The 1990 farm bill (Food, Agriculture, and Conservation Trade Act) included several key provisions to help wildlife. Among these, the act:

- 1) *beefed up the CRP program by offering more opportunities for cost-sharing activities,*
- 2) *allowed for the direct purchase of wetland habitats, and*
- 3) *allowed for financial incentives for protecting wetland habitats.*

Under this provision, landowners can receive direct financial payments up to \$250,000 for protecting wetlands with a 30-year or perpetual easement. In this case, the landowner agrees not to drain, fill, or destroy a wetland.

Beginning in the 1960s the federal government became more involved with wildlife management activities throughout Kansas because of the Classification and Multiple Use Act of 1964, which dictated that federal lands must be managed for a variety of uses including wildlife, timber, grazing, or recreation.

Wildlife practices were incorporated into the program plans of the Soil Conservation Services (SCS) and Agricultural Stabilization and Conservation Service (ASCS).

A Kansas Waterfowl Stamp was issued in 1987 and annually thereafter, and a turkey hunting permit was required by hunters beginning in 1974.

This period also signaled growth in training wildlife professionals to meet an ever-increasing demand. Professional wildlife training was begun at Kansas State University (KSU), Emporia State University, and Fort Hays State University. Beginning in 1954, KSU developed an Extension program in wildlife. Various private organizations have also had positive effects on the wildlife resource in Kansas. Groups included were the Nature Conservancy, Ducks Unlimited, Wild Turkey Federation, Quail Unlimited, Sierra Club, Audubon Society, Pheasants Forever, Kansas Ornithological Society, Kansas Chapter of the Wildlife Society, local sportsmen clubs, and various

other organizations. Not to be overlooked are the efforts of numerous concerned citizens and landowners.

In spite of all of the advances made in Kansas wildlife management over the past 50 years, the outlook for wildlife remains precarious. Man's ever-increasing demands on the environment and the continued destruction of habitat are the principal causes.

The private landowner holds the key to the future well-being of our wildlife resource. Less than 3 percent of the land in Kansas is owned by government agencies. It is clear the overwhelming majority is under the control of private citizens and corporations. Close cooperation between the private sector and governmental wildlife agencies is mandatory to ensure significant future progress for the wildlife resource.

**Table 1. List of important legislation affecting wildlife conservation.**

<b>1900</b>	Lacey Act
<b>1913</b>	Weeks–McLaren Act
<b>1918</b>	Migratory Bird Treaty Act
<b>1929</b>	Migratory Bird Conservation Act
<b>1934</b>	Migratory Bird Hunting Stamp Act
<b>1934, 1958</b>	Fish and Wildlife Coordination Act
<b>1934</b>	Taylor Grazing Act
<b>1937</b>	Federal Aid to Wildlife Restoration Act
<b>1940</b>	Bald Eagle Act
<b>1961</b>	Accelerated Wetlands Acquisition Act
<b>1964</b>	Wilderness Act
<b>1964</b>	Classification and Multiple Use Act
<b>1965</b>	Land and Water Conservation Fund Act
<b>1969</b>	National Environmental Policy Act
<b>1972</b>	Federal Environmental Protection and Control Act
<b>1972</b>	Marine Mammal Protection Act
<b>1973</b>	Endangered Species Act
<b>1980</b>	Nongame Wildlife Act
<b>1980</b>	Alaska National Interest Lands Act
<b>1985</b>	Food Security Act



*Overgrazing, converting grass to crops, wetland drainage, industrial development, pollution, and large-scale agriculture all had severe impacts on wildlife habitat and populations during the period of exploitation. These forces still have a tremendous impact today on the amount of undisturbed land wildlife need to survive.*



*Wildlife management in this country has its foundation in European customs and traditions, such as protecting breeding waterfowl like this northern shoveler.*



*Big bluestem grass is a common grass found in Kansas' original prairies.*



*During the period of protection, many of the colonies established seasons to protect white-tailed deer and to prevent the killing of deer for their hides.*

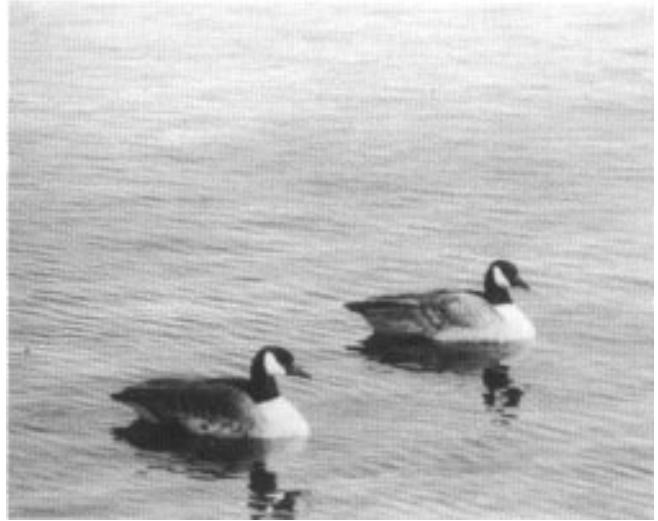

*The Migratory Bird Treaty Act established broad parameters for hunting ducks, geese, and swans, and it also protects songbirds and nongame birds, such as the snowy egret.*



*The 1990 farm bill has the potential to help wildlife populations by allowing for the direct purchase of wetland habitats and financial incentives for private landowners to protect wetlands on their land.*



*The Migratory Bird Hunting Stamp Act required waterfowl hunters to purchase a duck stamp before they could hunt ducks, geese, or swans. The money from the sale of stamps is used to purchase wetland habitats.*





## Questions for Chapter 2

1. Describe how wildlife management in North America was influenced by the Europeans.
2. Briefly describe the 6 major eras of wildlife conservation in North America.
3. What impact did Theodore Roosevelt have on wildlife conservation, and what was his Doctrine of Conservation?
4. Who was Aldo Leopold?

## Questions for Chapter 2 (continued)

5. What was the Pittman-Robertson Act, and how did it affect wildlife conservation in this country?

6. Describe how the Pittman-Robertson Act works and what the appropriated monies can be used for.

7. How can the 1985 and 1990 Farm Bills affect wildlife conservation?

Name \_\_\_\_\_

## Chapter 3

# Understanding How the System Works: Basic Ecological Principles

Charles L. Elliott

## How Nature is Organized

To understand wildlife management, a landowner should review some basic processes that go on in nature. Numerous wildlife management decisions are based on these principles. To help describe these natural processes, we must talk about ecology.

Ecology means the study of how and where plants and animals live. From a wildlife standpoint, think of ecology as the relationship between wild animals and their surroundings. A word we often use when discussing an animal's surroundings is **environment**. Thus, **ecology** is the relationship between living things and their environment.

To understand animal ecology and how a landowner can affect it, we need to discuss the **biological spectrum**. The natural world is not randomly arranged in a helter-skelter manner. Rather, it is organized into a scale of increasing structural and organizational complexity. This is what biologists refer to as the biological spectrum (Figure 1).

One example of the organization and interrelationships found in nature is how a species is related to its ecosystem. We can define ecosystem by understanding the concepts of **species** and **environment**.

We traditionally define an animal species in terms of its reproduction. We typically recognize a species as a group of individuals that:

- *successfully breed with one another,*
- *share ties of common parentage, and*
- *possess a pool of common genes.*

Stated more simply, a **species** is a group of plants or animals that have the same chromosomes and breed solely with each other. You probably refer to the species of wildlife found on your land as white-tailed deer, raccoons, and bobwhite quail. You recognize these animals as being different from one another.

All the individuals of a given species living in the same location are referred to as a **population**. For example, all the bobwhite quail in a particular woodlot constitute a population. That same woodlot could also be home to a population of raccoons, depending on the size of the woodlot. If we discuss all the animals in a specific area, e.g., all the animal populations on the Jones Farm or all the fish populations in Big Springs Lake, we would be talking about the **community** of animals on the Jones Farm or the

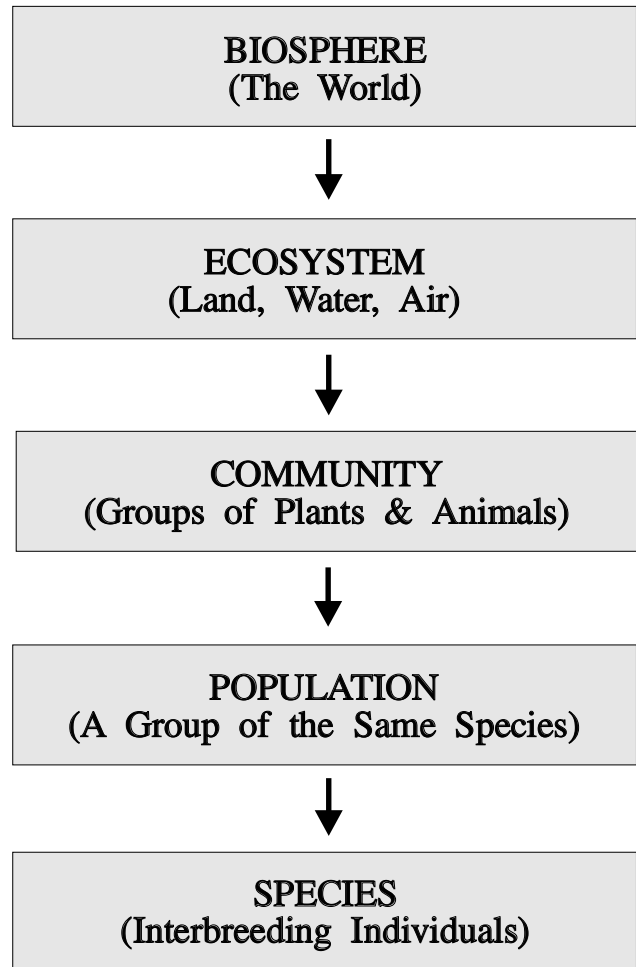

Figure 1. The biological spectrum

community of fish in Big Springs Lake.

All the animals and plants in an area (**the community**) and their surroundings (**the environment**) comprise an **ecosystem**. Putting these concepts together, we start to get an idea of the biological spectrum, and the organization found in nature.

As biologists learned more about the biological spectrum, they became more aware that disturbance to one part of nature is never just localized. Much like the ripples created by throwing a rock into a pond, the repercussions of an impact made on a species or community are felt

throughout the system. The “ripples” of disturbance affect all parts of the natural spectrum.

***The Big Fish Eats the Little Fish and Other Examples of How Nature Works***

The relationships within an ecological system are always changing. Members of an animal species are being born or are dying, and these changes affect the animal’s population, community, and ecosystem. Many of the changes occurring within an ecosystem depend directly or indirectly on a number of natural processes or cycles. How well these natural cycles operate, or if they operate at all, often depends on individual landowners because they decide what happens on their property.

The functions of an ecosystem depend on energy provided by sunlight. The sun’s energy, captured by green plants, is used for growth. The energy is stored as starches, proteins, or other vital components. The efficiency with which green plants transform and store solar energy from the sun is relatively low.

Efficient or not, plants are the most effective mechanism for converting solar energy into forms useful to animals and humans. This ability of plants makes them the basis for one of the most fundamental natural concepts: **the food chain**. The concept of a food chain often suggests the idea of “the little fish being eaten by the bigger fish” and is a general description of how a food chain operates. But, food chains are much more involved than one animal eating another.

Food chains are made up of **producers, consumers, and decomposers**. Plants are normally the major producers in a food chain because they take energy from the sun and convert it into a form usable by other creatures.

Consumers fall mainly into three categories: **herbivores, carnivores, and omnivores**.

Herbivores are those animals which eat only plants. These animals generally have a specialized digestive system (like those found in rabbits, deer, or cattle) which cannot break down foods other than plants.

Carnivores are meat-eaters. Even though many carnivores eat grasses at various times during the year, for the most part, they depend on meat. They consume plant material mainly to help clean out their digestive system. For example, coyotes and foxes eat berries and fruits during the summer and fall.

Omnivores are unique animals that eat both plant and animal matter. An example of an omnivore is the black bear.

Decomposers are organisms, like bacteria, fungi, and some insects, that help break down dead plant and animal material. Decomposers help return (recycle) nutrients and minerals to the natural system.

Let’s examine a simple food chain found in operation here in Kansas (Figure 2). The plant (clover) converts the sun’s energy into useful compounds that are stored in its

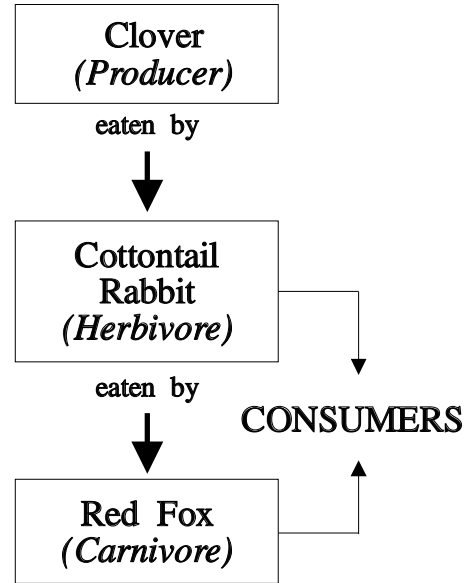

Figure 2

leaves and roots. The rabbit eats the clover to obtain the energy, protein, minerals, and other nutrients. If unfortunate enough to get caught by the red fox, the rabbit, through the nutrients in its tissues, would then be used to meet the nutrient requirements of the fox’s body.

What about the decomposers? When animals or plants die, nutrients in their bodies are returned to the environment by decomposers. The nutrients and minerals are released into the soil and recycled by other plants, producing more plant material, which feeds more rabbits and eventually more foxes (Figure 3).

Each step in a food chain contains energy. Each consumer will use about 90 percent of the energy it consumes to meet its basic needs (e.g., warm-blooded species use energy to maintain their internal body temperature). That means only 10 percent of the energy available at any level of a food chain can be used for anything other than life support. In our example of a food chain, only 10 percent of the energy obtained when the rabbit eats clover will be available for growth (if it is a young rabbit) or reproduction (if it is a pregnant female or a female with a litter of young).

Natural food chains are interconnected and form a food web. The term “web” is used to point out how things in nature are interrelated. In our food chain, the rabbit could be food for a number of other carnivores (coyotes, hawks, owls, etc.) and would be involved in several other food chains (Figure 4).

***What Goes Around Comes Around***

Plants and decomposers are an important part of any food web, but are also important in another natural cycle,

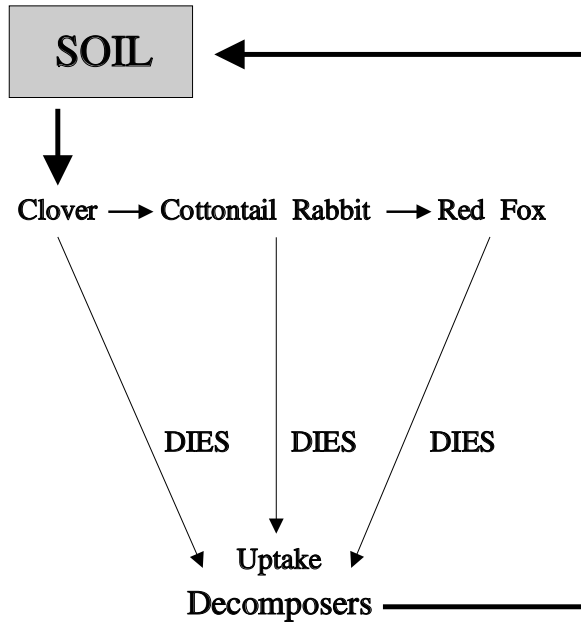

Figure 3

the mineral cycle. All plants and animals need minerals to survive, and wildlife obtain minerals from food. Carnivores obtain minerals from the animals they consume, whereas herbivores absorb the minerals they require from the plants they eat. Where do plants get the minerals they need, and why is it that the supply of minerals in nature does not run out?

This is a simple question with a lengthy answer.

Farmers or homeowners often apply fertilizers to their fields or lawns to produce more corn, soybeans, and wheat or to keep their lawn lush and green. This is an example of how plants need and respond to minerals.

Most fertilizers contain three basic minerals: nitrogen, phosphorus, and potassium. Just as crops and lawns need minerals to grow and produce, so do the plants found in natural environments. No one applies fertilizer to plants in the forest because decomposers, through the mineral cycle, provide most of the minerals to sustain plant life.

Most of the minerals needed by plants occur either as a gas in the atmosphere or as a mineral in the soil. Plants get the minerals that occur as a gas, such as carbon in carbon dioxide, through their leaves. Small openings, called stomata, on the underside of leaves allow plants to take in various atmospheric gases.

Plants can also absorb minerals through their roots. The minerals may be available in the soil as a result of natural processes, such as erosion, or through the activity of special soil bacteria.

Once absorbed by plants, the minerals become available to herbivores. After the herbivores have eaten the plants and taken the minerals into their bodies, the minerals are now available to any carnivore who eats the herbivore.

Plants are essential for wildlife because they provide the minerals animals need to survive. Animals must get the majority of minerals they need from their diet; however, sometimes sodium, phosphorus, or other minerals are in short supply, and wildlife can obtain minerals by eating soil (e.g., deer eating soil at a salt lick) or by chewing on shed deer antlers or bones.

Back to the question of why the supply of minerals in natural environments never runs out if plants are taking them out of the atmosphere and soil. As discussed earlier, all plants and animals take minerals into their tissues. When a rabbit or clover plant dies, it decomposes or rots. The decomposers, organisms like fungi (mushrooms, toadstools, etc.) and bacteria, feed on dead plants or animals and break them down.

This breakdown results in a release of either minerals and nutrients which plants can use, or gaseous byproducts which help replenish the supply of atmospheric gases. Because the mineral cycle supplies most plant and animal requirements, no one needs to apply fertilizer in a forest.

Food chains, food webs, and mineral cycles are examples of how natural processes, if allowed to function properly, contribute to the “balance” of nature and well-being of all wildlife. Thus, a landowner can adversely affect this delicate balance in two ways:

- by spraying a herbicide which may eliminate some

### SIMPLE FOOD WEB

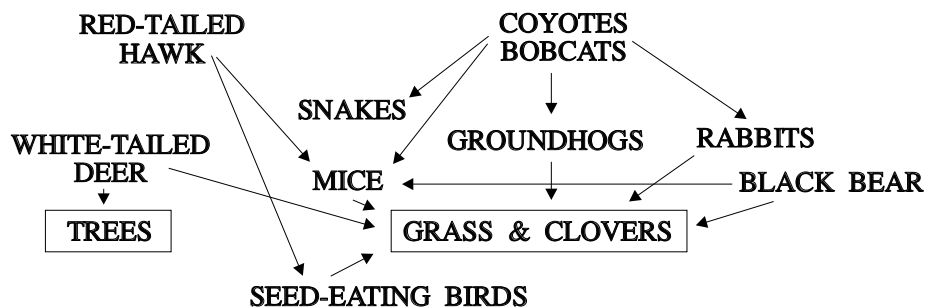

Figure 4

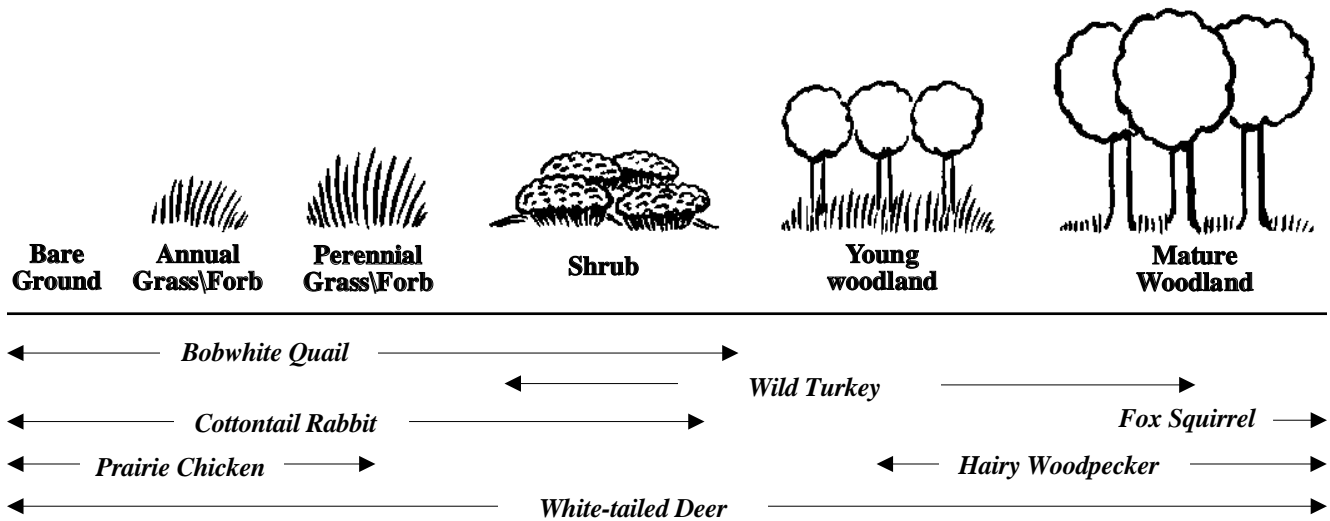

Figure 5

food plants that wildlife depend on, or which may destroy bacteria, fungi, and other decomposers in the soil, or

- by applying a pesticide to eliminate certain soil pests.

In either case, all wildlife in the area would suffer.

### Going Back to Woods, or How Plant Communities Change

Matching land management with wildlife requires an understanding of another natural process called **plant succession**. Plant communities are not fixed in time, changing as the types and numbers of plants in an area change. Most landowners know about plant succession; they just refer to it by different terms. When fields have been abandoned and people talk about the field “going back to grass,” they are talking about plant succession.

Plant succession is nothing more than a self-directed, orderly, and predictable change in plant communities (Figure 5). Just as plant communities change from annual weeds to the final community of oaks and hickories, animal communities also change (Table 1).

Let’s examine an example of plant succession and how changes in plant communities can affect wildlife. Consider an abandoned soybean field in Kansas. During the first year, light, airborne-seeded plants, such as foxtail, become established. At this time, mourning doves and songbirds find the area desirable because they feed on seeds produced by **annual** weeds (those which grow, produce seed, and die each year), such as ragweed and foxtail grass.

As time goes by, the field will become filled with heavy-seeded **perennial** (plants which survive for more than one year) weeds, grasses, and legumes. This type of plant community favors quail, cottontail rabbit, and numerous other small mammals like voles or deer mice. In turn, these species provide abundant food for red foxes,

coyotes, hawks, and owls. Turkey broods find such areas useful for feeding on seeds and insects.

During the third to eighth year, broomsedge, grasses, blackberries, and hardwood tree sprouts form briar thickets and other thick, brushy areas, creating habitats that favor cottontail rabbits, bobwhite quail, deer, and many species of songbirds. Deer browse and cover are generally greater during this period than at any other time. Nesting sites for dove, quail, and turkeys are abundant during this stage.

For example, in eastern Kansas where the shrubs and trees grow larger and begin to shade the ground, the weeds that once grew in the field start to get shaded out. As the trees grow larger, they start to shade out even more plant life growing on the ground. A wide variety of wildlife will use these areas for nesting and cover.

As the forest matures, a plant community appears that is not replaced as long as major climate changes do not occur. This last community may survive for hundreds of years or until something happens to disturb the community. This relatively stable, long-term plant community is called the **climax community**. In much of Kansas, the climax community is the grasslands. In the far eastern part of Kansas, it is mature woodland.

There, during the final stages of succession, cavity-nesting wildlife, such as raccoons, tree squirrels, and owls, in addition to turkey and gray fox, flourish.

Each species of wild animal thrives only in those plant successional stages that can meet its requirements for survival. Some animals require that a specific stage of plant succession be abundant for their population levels to be high (cottontail rabbits need shrub fields, for example), whereas other species (white-tailed deer, bobwhite quail) need to have a variety of plant successional stages available to meet their needs.

Generally, during succession, the number of species or **diversity** increases with each successive plant community.

However, the climax community does not have the greatest variety of species. Diversity peaks some time before the climax community appears. Stated another way, as more plant species appear and their diversity increases, succession moves forward.

**Why Animals Live Where They Do**

Why are certain wildlife species attracted to different stages of plant succession? Again, it’s a simple question with a complex answer. All wild animals live within a **range of tolerance** for each of the physical and biological components of their environment. For instance, there is a range of temperatures in which a gray squirrel, quail, or trout can survive and reproduce. If it becomes too hot or too cold, the animal cannot function normally.

All animals die when critical bodily functions are reduced or stopped. Different ranges of tolerances restrict species within certain environments. For example, the ptarmigan cannot survive as far south as Michigan because it is not adapted for the climate there. Thus, groups of animal species with similar tolerances form communities within ecosystems.

Plants and animals survive as long as they can compete successfully for resources. When an animal can no longer compete for food, for the right to breed, or for the resources necessary to its survival, it is doomed to disappear.

Each species of plant or animal is the product of a long history controlled mainly by competition. The genes of individuals that can compete and adapt to their environment are passed onto the next generation. Individuals that cannot compete are eventually eliminated. As a result, species are constantly adapting to their environment.

Thus, each species has a unique role in an ecosystem. This role or “job” an animal performs in an ecosystem is known as its **niche**. Some wild animals are so adapted to their particular environment that they cannot survive well without it. These species have a very narrow range of tolerance, and we call these individuals **specialists**

(Figure 6). Specialists are often the animals we hear about when people refer to wildlife that are in danger of extinction (**endangered species**).

Other species are **generalists** that can deal with a broad set of environmental conditions. These animals prosper under new conditions and are frequently the wildlife adjusting well to environments created by towns and cities (opossums, house mice, starlings, coyotes). Whether they are specialists or generalists, all animals have a unique ability for living within their own range of tolerance.

Even though it may appear that two animal species have similar “jobs,” no two species are exactly the same. For instance, robins and moles both feed largely on earthworms, but each finds food in a different way and in different locations. Robins feed at the soil surface in open areas, and they locate their prey by sight. Moles dig about in moist soils and have special front feet and a long snout equipped with sensitive nerves for detecting the underground movements of worms. This way the species avoid competition, and their niches do not overlap.

**Recognizing the Big Picture**

With an understanding of some of the basic ecological processes that function in nature, landowners are likely to recognize that:

- (a) *changing a natural community for any purpose will alter the patterns in which energy and matter flow through an ecosystem;*
- (b) *communities vary in their tolerance for disturbance;*
- (c) *as plant communities change through succession, animal communities also change;*
- (d) *effectively managing wildlife on private property means recognizing the degree to which communities are disrupted when plant and animal populations are manipulated; and*
- (e) *as a property owner, you are the “landlord” or “steward” of all wildlife on the land under your care.*

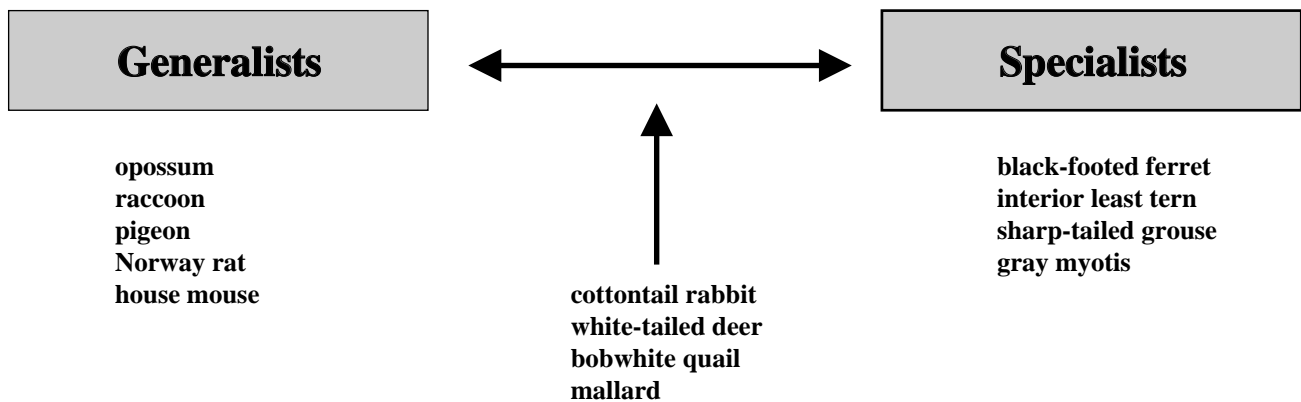

Figure 6

Table 1. Generalized schema of common terrestrial vertebrate species along a successional gradient of the grassland to the oak forest.

Grass-Forb	Shrub	Shrub-Small Tree	Mature Forest
<b>Birds</b>			
red-winged blackbird	cardinal	bobwhite	red-eyed vireo
eastern meadowlark	bobwhite	cardinal	scarlet tanager
eastern kingbird	prairie warbler	brown thrasher	summer tanager
American goldfinch	mockingbird	wild turkey	tufted titmouse
prairie warbler	indigo bunting	blue jay	wild turkey
field sparrow		Carolina chickadee	ovenbird
grasshopper sparrow			red-bellied woodpecker
mourning dove			
greater prairie chicken			
<b>Mammals</b>			
prairie vole	meadow vole	white-footed mouse	white-footed mouse
meadow vole	white-footed mouse	short-tailed shrew	short-tailed shrew
deer mouse	least shrew	white-tailed deer	bobcat
least shrew	short-tailed shrew	western harvest mouse	gray squirrel
prairie dog	white-tailed deer	eastern chipmunk	fox squirrel
eastern mole	western harvest mouse	coyote	flying squirrel
woodchuck	eastern cottontail	bobcat	
badger	woodchuck		
coyote	coyote		
<b>Reptiles and Amphibians</b>			
garter snake	five-lined skink	American toad	timber rattlesnake
box turtle	box turtle	box turtle	black rat snake
American toad	American toad	copperhead	American toad
hognose snake	hognose snake	rough green snake	eastern hognose snake
leopard frog	ribbon snake	fence lizard	fence lizard
prairie rattlesnake		five-lined skink	copperhead
			broadhead skink

\*winter resident





*Plants, like Indiangrass, are the first step in the food chain. Plants are called producers because they take energy from the sun and convert it into a form usable by other organisms.*

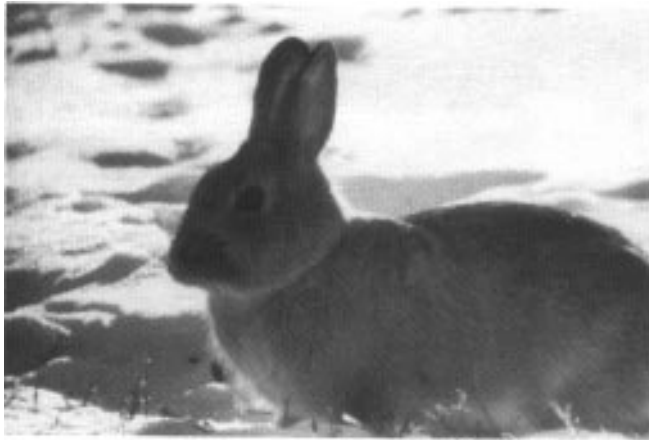

*Herbivores, like cottontail rabbits, are plant eaters and may become food for carnivores.*

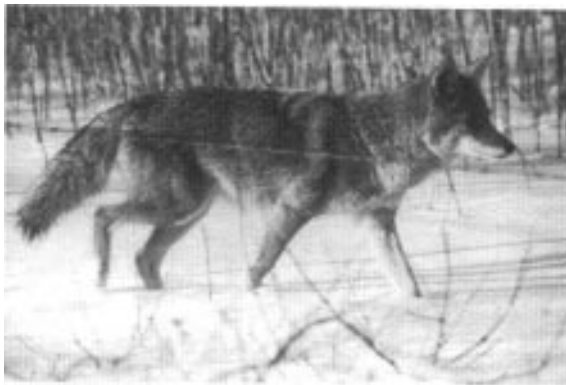

*Coyotes are meat eaters, although they may eat plant materials during certain seasons of the year.*



*The raccoon is an omnivore and will eat meat, fruits, berries, carrion, and green leafy grasses and weeds.*



*Each animal has a unique role in the environment. This niche is determined by a range of factors and adaptations that make each animal unique. Notice the difference in bill and leg length between the green-backed heron and great egret. The longer bill and legs of the great egret allow it to eat different types of foods and feed in different types of aquatic habitats. Thus, great egrets and green-backed herons have a different niche.*



*The opossum is a generalist because it can live in a wide variety of habitats, including forests, fields, and cities, and it eats a wide variety of foods, including plants, animals, and other living or dead organisms.*



## Questions for Chapter 3

1. List and describe each level of the biological spectrum.
2. What is the difference between a herbivore, a carnivore, an omnivore, and a decomposer?
3. What is a food chain and a food web?
4. Why is the mineral cycle important for living organisms?

### Questions for Chapter 3 (continued)

5. What is plant succession? Why is it important to understand the concept of plant and animal succession?

6. What is the difference between a specialist and a generalist?

7. What is an animal's niche?

Name \_\_\_\_\_

## Chapter 4

# Food, Water, Cover, and Space: What Wildlife Require

*Charles L. Elliott and Thomas G. Barnes*

Every animal must live somewhere, but all animals cannot live everywhere. Thus, caribou live in Alaska and not Kansas, while Neosho madtoms live in Kansas and not in Alaska.

Each species of wild animal requires a general environment in which to live. To properly manage the land for the benefit of wildlife, landowners must be aware of those things in the general environment that wildlife need to survive and reproduce.

The general environment, or natural home where a wild animal lives, is called its **habitat** (Figure 1). Just as we called an animal's niche its "job" in Chapter 3, similarly, we might call its habitat its "home."

## Basic Wildlife Requirements

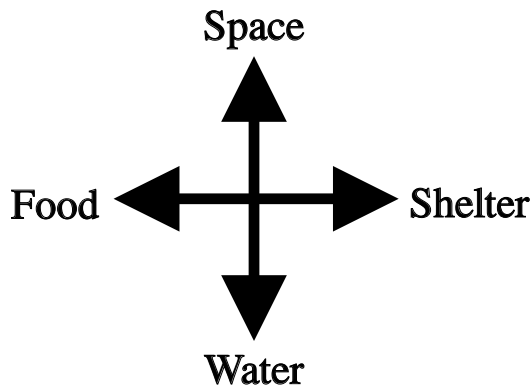

## *Habitat is the Key*

*Figure 1*

Just like humans, wild animals have specific requirements they get at home. The habitat for any wild animal must provide the same things you need:

- *cover from weather and predators,*
- *food and water for nourishment, and*
- *space to gather food and water and breed.*

This chapter is about understanding what home means to wildlife, and how you can manage your property to provide more homes for wildlife.

The selection of habitat is a specialized process that has taken hundreds of years to develop. When an animal selects a certain place to call home, it often restricts itself to

a certain type of area and quite often will become specialized for the particular combination of features found in that habitat.

While shelter, food, and water are basic requirements, how wildlife obtain these requirements varies. Thus, Kansas does not have wolverines because we do not have the dense forests that these animals require in a habitat. Similarly, Kansas has an abundant cottontail rabbit population because the state has the type of habitat rabbits require: a mixture of one-third grasslands, one-third croplands, and one-third shrubby or woody cover.

To understand how habitat affects wild animal populations, we must understand the basic components of habitat: cover, food, water, and space.

## *Animals Need a Place to Hide, Rest, Move About, and Breed*

Cover is any part of an animal's environment that enhances the survival or reproduction of the animal. Often, landowners, and almost everybody else, think of cover as something animals hide under. Actually wildlife cover has two components:

- *it provides shelter from adverse weather conditions (winter or thermal cover) and*
- *it provides protection from predators (screening or escape cover).*

Animals do need things in their environment to hide under, but cover also includes having something to hide behind, or some type of obstruction between the animal and a potential predator.

Thus, cover is three-dimensional and is related to the functional needs of animals. For example, many people in Kansas have had the experience of seeing a deer in an open field. If the deer is disturbed, it will flee. Often, the animal will stop and resume feeding once it has retreated back into the timber, even though you might be able to see it. The deer gets enough **horizontal cover** (*space between the animal and you*) to feel secure.

An overgrown fence line or weed-filled ditch may not look like good wildlife cover because the plants are not very tall, but the horizontal cover it provides may be all that foxes need to feel secure, or that deer need to feel comfortable while feeding in surrounding fields.

Wildlife also need cover for nesting, escaping predators, breeding, rearing young, and relaxing. The general habitat and cover requirement for bobwhite quail is a mixture of 30 to 40 percent grassland, 40 to 60 percent croplands, and 5 to 40 percent brushy or wooded cover. Closer examination reveals that bobwhite quail require a wide array of cover types for different functions or activities throughout the year. These cover types can be classified as:

- **nesting cover** (*moderately dense grass-broadleaf weed mixture with nearly bare ground around grass clumps*);
- **roosting cover** (*grasslands with short-statured vegetation approximately 2 feet high with an open canopy for uninhibited movement*);
- **screening or escape cover** (*low growing shrubby or woody areas, such as brushy fencerows or field dividers*);
- **dusting cover** (*dry, powdery, bare ground*);
- **brood-rearing cover** (*insect-rich mixtures of legumes or herbs with bare ground for movement*);
- **loafing cover** (*where quail can escape potential predators easily*); and
- **thermal or winter cover** (*dense ground cover under a woody canopy*).

Some animals are not very selective about what they use for cover; for example, opossums can live in almost any type of habitat, including towns and cities. Other animals are selective about the type of cover they require.

Providing cover for one wildlife species is not without its problems because it may decrease the cover for another desirable species. Cover requirements between desirable species may be similar, and managing cover for bobwhite quail may result in benefiting cottontail rabbits and cardinals.

Given the interrelated cover needs of numerous wildlife species, it is probably impossible to manage cover for one species without influencing others. Whatever form it takes, cover contributes to the “patchiness” of plant life and often enhances the different types of wildlife found.

Landowners must also consider what constitutes a proper breeding site (areas where wildlife can build a den, nest, or dig a burrow to give birth and raise young). Sometimes it may appear that the habitat provides everything wildlife need to survive and prosper, yet the population never seems to increase. This failure to increase may be related to a lack of breeding sites.

Most landowners know the type of plants to leave as nest sites for turkeys, or the kinds of den trees raccoons are likely to use. With an awareness of the habitat needed by those species they wish to promote, property owners can protect or provide needed breeding sites.

One final aspect of cover important for landowners to understand is the concept of **travel corridors**. Travel corridors are areas of continuous or unbroken habitat that

permit animals to travel securely from one habitat to another.

As environments become more broken up (**fragmented**) from road construction, parking lot development, urban sprawl, timber harvesting, agricultural clearing, coal mining, or industrial development, small islands of natural habitat remain.

Travel corridors connect these islands and should be preserved, maintained, or created, if possible, because they allow animals to find and use the islands of suitable habitat.

### ***What to Eat with So Many Choices Out There***

Obviously, wildlife must have food to survive. Animals having adequate food and proper nutrition throughout their lives grow larger and remain healthier than animals that experience poor nutrition during part or all of their lives. Generally, wildlife in good condition have higher reproduction rates, are more resistant to diseases, and can escape predators better than animals in poor condition. Thus, nutrition affects birth and death rates and is important in the overall survival of any wild animal population.

The availability of food varies over time (season) and space (geographic location); thus, food can be abundant in one area during one season and in critically short supply in another area during other seasons.

In Kansas, wild animals experience nutritional stress in winter and very early spring. During this period many of the natural food sources have been depleted or may become unavailable because of snow cover. Cold weather forces animals to consume more food to maintain body heat. If food supplies are the focus of your management plan, you should provide high-quality food during winter and early spring.

Diet selection in wild animals is driven by the quantity and quality of food available in concert with the natural adaptations of the animal. For instance, coyotes are carnivores adapted for eating a diet of small animals (mice, voles, etc.) during much of the year. However, when insects, fruits, and berries are abundant in summer, as much as 80 percent of a coyote’s diet will consist of insects, fruits, and berries. Likewise, turkeys and bobwhite quail are seed or grain eaters (**granivores**) much of the year, but they consume large amounts of insects (**insectivores**) during the reproductive season to meet their high-protein requirement during this season.

Food availability to a predator means prey availability. Predators generally do not experience problems with diet quality because most animal matter is nutritionally complete and easy to digest. Even though carnivores expend a large amount of energy in searching for, chasing, capturing, and killing their food, this extra expenditure of

energy is offset by the higher nutrient concentration found in animal matter.

Herbivores or plant eaters may become nutritionally stressed by a lack or shortage of food (*quantity*) or by a lack of highly nutritious food (*quality*). For example, in years when acorns are abundant, white-tailed deer are healthier because much of their diet consists of high-energy acorns. During years when the acorn crop is not very good, deer still have plenty of food to eat (tree twigs, grass, etc.), but they may become nutritionally stressed because these plants do not contain as much energy as acorns.

Herbivores do not feed randomly in the environment, but show definite feeding patterns. These patterns are called **food preferences** (ranking a food according to how much of the plant material is found in the diet in relationship to how much is found in the environment). Foods are classified as:

- **preferred** *if they are more abundant in an animal's diet compared to its abundance in nature;*
- **staple** *if they are eaten on a regular basis and meet the nutritional needs of the animal (an animal's second choice);*
- **emergency** *if they are eaten to fulfill short-term nutritional needs; and*
- **stuffers** *if they are eaten because there is nothing else to eat.*

Everyone can appreciate that food is necessary for animals, but few landowners understand the difference between **starvation** and **malnutrition**. This is related to our perception that food appears to be available, yet food-related problems begin appearing in the wildlife populations.

Wild animals die from starvation because they do not get enough food to survive (a lack of food quantity). Carnivores typically die because they cannot catch enough to eat. If something has happened to reduce or eliminate the rabbit or small mammal populations in an area, a red fox living in that region may starve.

Animals die from malnutrition because they cannot find food that meets their nutritional needs (a lack of food quality). Plant eaters sometimes suffer because of malnutrition. Deer usually do not die because they cannot find enough to eat. They perish because what they do eat is either not nutritious enough to maintain their bodies or not able to meet the demands put on them by reproduction or mating.

Although the woods and fields may look green covered with lush plants, this does not mean deer and other herbivores in the area have adequate food. A key to managing food supplies for herbivores becomes one of matching the animals' food habits with what the environment provides.

Winter malnutrition can adversely affect the next generation of young animals. Young, growing animals require more protein than adults. While milk supplies the protein needed by juvenile mammals, young carnivores

often supplement the demand for protein with meat. For young herbivores, an adequate supply of milk is a necessity.

In white-tailed deer, the nutrient level in milk remains the same regardless of the doe's condition. However, the quantity of milk produced declines with malnutrition. Fawns born to does that struggled through a difficult winter may have little or no milk available to them, and they often die.

Landowners need to be especially aware of the problem of malnutrition. What individuals do to the plant communities on their property influences the severity of malnutrition for the animals in the area.

Eliminating plants with high nutritional value can have just as devastating an impact on an animal population as shooting them with a gun. Conversely, a landowner who manages land so that certain types of plants and plant communities flourish, or who plants high-quality vegetation for animals (food plots), can increase local wildlife populations.

Supplemental feeding of wildlife is not often economically feasible or biologically desirable, so management efforts should be concentrated on preventing nutritional problems before they occur. The best way to prevent nutritional problems is to provide high-quality, preferred natural foods. This is accomplished by managing the habitat.

### *A Dirty or Thirsty Animal Is an Unhappy Animal*

Animals require water for several reasons: digestion and metabolism, reducing body temperature, and removal of metabolic wastes. Some wildlife can survive for weeks without food but only days without water. The supply of free-standing water in Kansas is at times a major concern in far western Kansas. In eastern Kansas, springs, creeks, and farm ponds provide adequate standing water for most species of wildlife.

Wildlife also obtain water through a diet of green plants, from dew on leaves, or as a byproduct of the body breaking down fat and starches. Water requirements of animals vary, and we sometimes overestimate the importance of free-standing water. However, the availability and proper distribution of standing water usually enhance a population.

Growth, size, reproduction, and general body condition usually benefit from optimum water supplies. A rule-of-thumb guideline would be to provide permanent water sources no more than one-half mile apart.

When a wildlife species does require drinking water, its habitat must include a permanent water source, or the animal must move (**migrate**) to areas with water during dry weather.

Wild animals will not inhabit areas too far from water, even if food and cover are abundant. Even though Kansas

wildlife typically do not have problems with water availability, they do have problems with undisturbed access to water. Free-roaming dogs can create enough disturbance (such as chasing deer or other wildlife) to cause animals to abandon a watering area and search for a more secluded place to drink.

### *A Home on the Range*

Each wildlife species requires a certain amount of space to move about, avoid or escape potential predators, locate a mate, obtain sufficient food and water for survival, and rest. This space is often referred to as the **home range** of an animal. Space requirements are behavioral and social responses that have taken hundreds of years to develop, ensuring an animal's well-being.

Wildlife space requirements vary by species, but generally, the amount of space required is determined by the quantity and quality of food, cover, and water (habitat) found in an area. Other factors affecting space needs of wildlife include:

- **how large the animal is** (*larger animals require more space*),
- **the animals' dietary preferences** (*carnivores generally require more space than herbivores*), and
- **how well the animal can withstand crowded conditions.**

Space requirements (as a function of habitat quantity and quality) essentially determine the carrying capacity of the site for wildlife. Often, you can increase the carrying capacity by increasing the quantity and quality of the wildlife habitat components. A long-term increase in population can only be accomplished by increasing the habitat's carrying capacity.

### *Is There a Method to This Madness?*

Knowing what animals need in their habitat, and trying to meet those needs, is only half the battle for the landowner who desires to promote wildlife on his/her property. Simply having considerable amounts of food, cover, or water on your property does not ensure that you will have abundant wildlife.

Within any area, large quantities of potential food, water, or cover may be unused because they are too far apart in relation to the customary travels of the animals in the area. An animal could travel a long distance to find water if necessary, but it would do little good if the animal starved or was eaten by a predator along the way. Properly arranging the habitat's components is important to ensure that each component benefits wildlife. Accomplishing this goal requires an understanding of **edge, interspersions, vertical layering, headquarters, and travel corridors.**

Wildlife requirements for food, cover, and water vary according to:

- *wildlife species,*
- *age and sex,*
- *physiological condition (gestation, lactation, antler growth, etc.),*
- *time of year, and*
- *geographic location.*

In addition, most residential wildlife (wildlife that do not migrate or travel large distances) rarely travel more than one-quarter to one-half mile from the place where they were born.

Because of these differences, the chances of meeting all the habitat requirements of various wildlife species are improved if you mix up or arrange each habitat component (food, cover, water) in a 160- to 320-acre block.

This mixing or arranging is called **interspersions** or **horizontal arrangement**. Stated another way, interspersions is the intermixing of different habitat types (forests, prairies, pastures, cropland, etc.) or plant communities.

Think of it as a puzzle. All the pieces of the puzzle must be present and in the proper order for the puzzle to be complete. The greater the mixing of habitat types of an area, the greater the interspersions. This is important because wildlife have a tendency to be more abundant in areas with high interspersions.

Within a forest community, how the plants grow in different layers is also an important type of arrangement called **vertical layering**. This is important because some wildlife species may use the **ground layer (herbaceous)** for food, but also need the tallest layer (**tree canopy**) for shelter.

The middle layer between the tree canopy and herbaceous layer is comprised of shrubs (shrub layer). Every mature forest community has different vertical layering. Some may have a variety of layers comprised of grasses, broadleaf weeds (forbs), shrubs, small trees, and large trees, whereas others may only have one distinct layer of tall trees. The latter would provide fewer habitats for wildlife compared to the forest stand with a variety of layers (Figure 2).

The boundary where two or more different plant communities or successional stages (such as where a forest meets a pasture or cropland) meet is called **edge**. Sometimes there is an abrupt change between plant communities. Other times there is no sharp or distinct difference but only a gradual change from one plant community to another. Edge looks a little like both plant communities or successional stages in places where the gradual transition occurs. Gradual edges with strong vertical layering share characteristics of both plant communities; therefore, wildlife species can find a greater selection of food and cover necessary to meet their requirements in these areas.



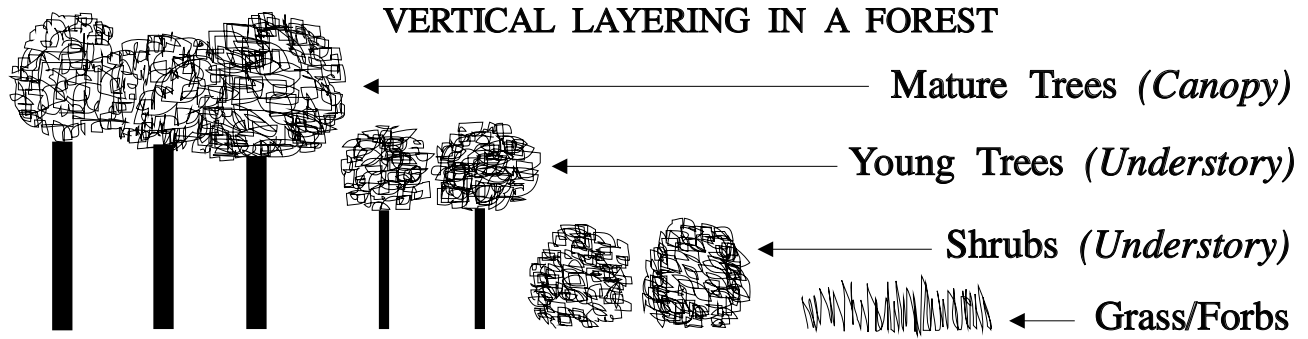

Figure 2

Headquarters (**covert or prime habitat corner**) are points where more than three vegetation or habitat types meet (Figure 3). Headquarters are very attractive to wildlife because they provide a greater variety of habitat components in a small area. Management plans should encourage a large number of headquarters since these areas provide many of the needs of wildlife.

Large amounts of edge and highly interspersed landscapes are not beneficial for all wildlife species. Some wildlife species need unbroken areas in a certain successional stage to provide some or all of their habitat requirements. For example, some songbird species need unbroken tracts of mature forest to meet their habitat requirements.

Landowners who control large sections of land should consider trying to create a balance of edge with blocks of unbroken forest if they are trying to attract a diversity of wildlife species.

There is a simple way to measure the amount of edge and interspersed on your property. Obtain an aerial photograph and soil mapping of your property from the Agricultural Stabilization and Conservation Service (you will need one later to serve as a planning document). Draw two imaginary lines connecting each corner of your property boundary (Figure 4). Count the number of times the habitat changes along each line. Next add these two numbers together to get an **interspersion index value**. The higher the value, the better it is for quail, rabbits, and other wildlife species that like areas with high interspersed.

You can also circle each point where three vegetation types occur to obtain information on how many headquarter areas are on the property.

**Summary**

This section has pointed out that habitat is the key to successfully managing wildlife. All animals require food, water, cover, and space to survive. Landowners must be aware of each of these factors and how they are arranged on their property if they wish to maximize wildlife use of the area.

**160 ACRE FIELD**

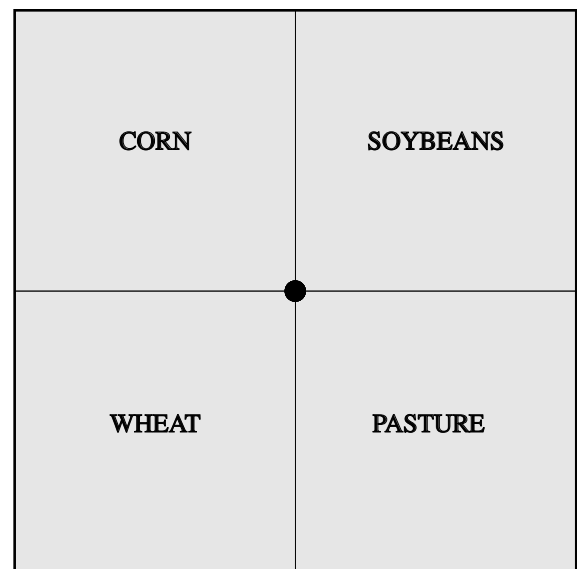

● *Headquarters (prime habitat corner)*

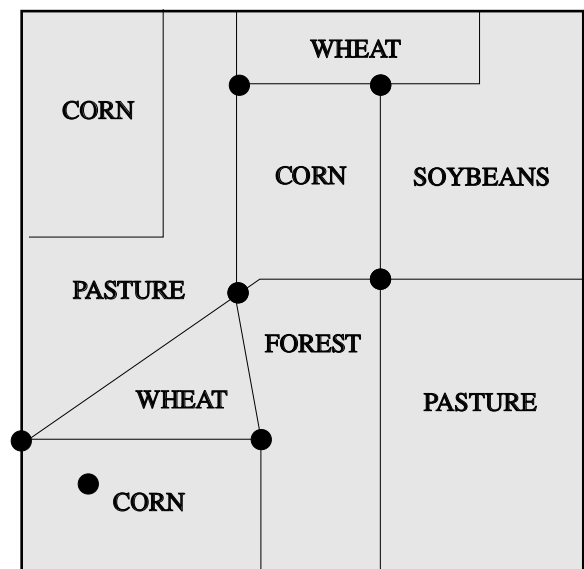
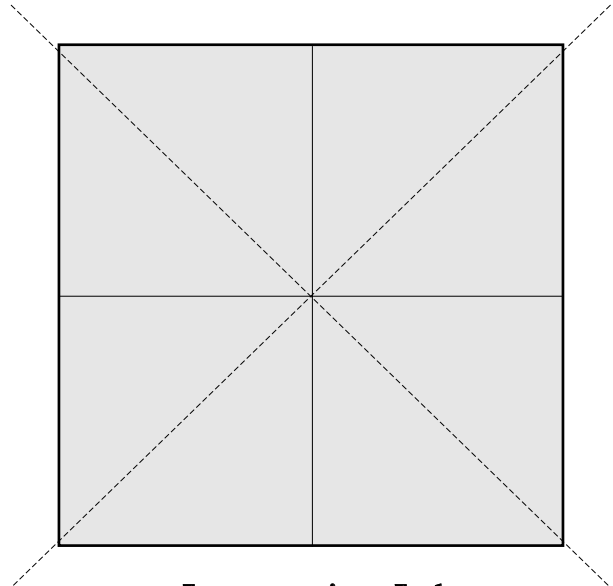

Figure 3

Much of the art of wildlife management is trying to recognize which habitat component is missing and providing that missing component by manipulating the vegetation.



**Interspersion Index**

**Line 1 = 1**  
**Line 2 = 1**  
**Total = 2**

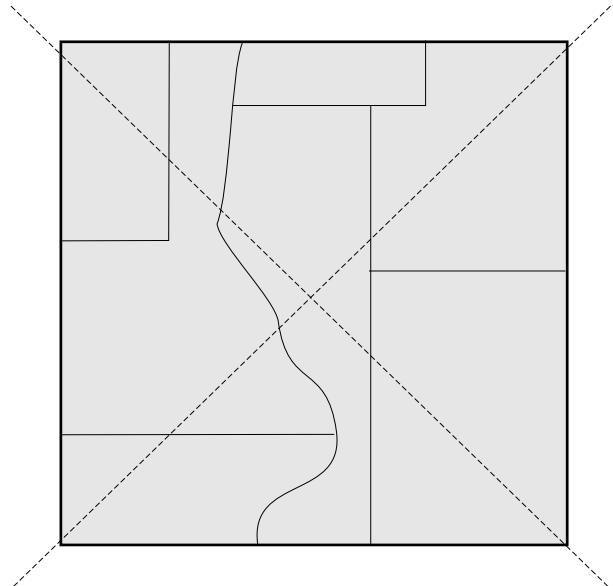

**Interspersion Index**

**Line 1 = 3**  
**Line 2 = 3**  
**Total = 6**

*Figure 4*



*Caribou do not live in Kansas because we do not have the right type of general environment or habitat for their survival.*



*These photographs illustrate the lack of suitable travel corridors connecting one habitat to another. The strip-mined area shows how the environment is being fragmented, which is having an impact on songbird populations on this continent. The large agricultural field provides little cover for wildlife.*

*Cover requirements for species vary according to the needs of the animal. The cave provides important wintering hibernacula and summer maternity sites for big brown bats; the rock shelter and surrounding forest are summer feeding and roosting cover for the bats.*



*Interspersion of habitats. Notice the mixture of different fields, forests, and fencerows in this photograph. This is a good example of interspersed or horizontal arrangement of different habitat types.*

*The boundary where different habitat types, such as the forest, the corn, the grass, and the wheat field, come together is called edge. A general rule of thumb suggests the more edge on a property, the more wildlife will be present.*



## Questions for Chapter 4

1. Describe what is included in the term habitat.
2. Describe the different types of cover any particular animal may require.
3. What type of cover do bobwhite quail require?
4. Why is it important to maintain travel corridors in the environment?
5. Why is it important to distinguish between food quantity and food quality for herbivorous animals?

### Questions for Chapter 4 (continued)

6. What is a food preference?

7. What is the difference between starvation and malnutrition?

8. Why do wildlife require water?

9. Why do animals require space or territory?

10. What is the difference between edge, interspersions, and vertical layering?

11. Why are headquarters and travel corridors important for wildlife?

Name \_\_\_\_\_

## Chapter 5

# Animals Everywhere: The Basics of Population Dynamics

*Michael J. Lacki*

All forms of wildlife, regardless of the species, will respond to changes in habitat, hunting or trapping, and weather conditions with fluctuations in the number of individuals present. Most landowners have probably experienced changes in wildlife abundance from year to year without really knowing why there are fewer individuals in some years than others. In many cases, these changes in abundance are normal and to be expected.

The purpose of this chapter is to help landowners understand why animal numbers may vary or change. While a number of important concepts will be discussed, one underlying theme should always be remembered. Regardless of whether a property is manipulated or not in any given year, there is always some change in the habitat, however small. Wildlife must adjust to this change and, therefore, no population is ever the same from one year to the next.

Traditionally, wildlife professionals refer to the number of individuals of a particular species within a given locality as a **population**. They use the term dynamics to describe the shift in the number and composition of individuals over time. Thus, they estimated the Kansas white-tailed deer population as 50,000 during 1960 and 400,000 in 1991.

Why is it important to understand how many deer are in Kansas or in your particular location? Depending on a landowner's objectives, the goal may be to increase, stabilize, or decrease the population.

Many management objectives can be accomplished by manipulating the habitat. Others may require direct manipulation of the animal population to achieve the desired result. Thus, if you are sustaining considerable economic damage from deer browsing on soybeans or wheat, you must manipulate the population directly by **harvesting** or removing animals from the population.

As has been mentioned previously, habitat components and animal space requirements determine the carrying capacity for wildlife species. One of the interesting phenomena observed in wildlife species occurs when populations are low with respect to the maximum number of individuals an environment can support. Under these conditions, **birth rates** (number of live births per female per year) have a tendency to be high. When a population is at or near the maximum number the environment can support, birth rates are low and **death rates** (number of

animals in the population dying per year) are high. Thus, both birth and death rates vary in relation to population numbers. This phenomenon is called **density dependence**. These concepts show that landowners should understand basic population dynamics when making decisions affecting wildlife on their property.

## *How Many Offspring Can Wildlife Have, and What Prevents Them from Having More?*

Most people realize that some wildlife species can produce more offspring than others. White-tailed deer are genetically programmed to have two fawns, whereas wild turkey are programmed to lay 10 to 12 eggs per clutch. Thus, each species has a **maximum genetic reproductive potential** or **biotic potential**.

Biotic potential describes a population's ability to grow over time through reproduction. Most bat species are likely to produce one offspring per year. In contrast, a female cottontail will have a litter size of approximately five. If conditions are good, she may produce a second or even third litter before the summer is over.

Cottontail rabbits have a much higher biotic potential or **intrinsic rate of population increase** than bats because they can add more members to their population over the same period of time. Animals with a higher biotic potential can respond better to habitat changes or some other type of change more readily than those species with a lower biotic potential.

It is important to remember that with any habitat improvement project, animal numbers will respond only if the most restricting habitat factor (food, water, cover) has been changed. Stated another way, a **limiting factor** is a basic requirement that is in short supply and that prevents or limits a particular wildlife population in an area from growing.

This limiting factor is often difficult to determine beforehand, even for the most experienced wildlife professional. Thus, part of the art of wildlife management is determining which factor(s) are preventing white-tailed deer from producing twins or preventing cottontail rabbits from producing two or three litters of five. It becomes apparent that managing populations is linked to habitat management.

While all populations sustain varying capabilities for growth in numbers, they all experience **environmental**

**constraints or decimating factors.** These constraints may take the form of predators, disease, hunting, trapping, or weather.

It is important to understand the differences between limiting factors and environmental constraints. A lack of food, cover, or water limits a population. Remember our example of food quality limiting reproductive success in white-tailed deer (Chapter 4). Food was a limiting factor because the poor nutritional level of deer during the rutting season affected the survival of offspring.

Other examples of limiting factors may be appropriate nesting, brood, loafing, and/or winter cover for quail or cottontail rabbits to escape the harsh effects of weather or predation. Thus, a landowner who chooses to reduce the size of individual grain fields in an attempt to reduce soil erosion could also increase the number of bobwhite quail or cottontail rabbits through an increase in the total length and width of hedgerows or field borders (improving cover). This, of course, assumes insufficient cover is the limiting factor for quail and rabbits.

In many respects, providing critical limiting factors alleviates or reduces the potentially harmful effects of decimating factors.

Decimating factors can depress or reduce populations, but in most cases these factors do not control animal abundance. In some cases, decimating factors (such as severe overhunting of white-tailed deer or waterfowl, the introduction of new parasites or predators, or unusually severe weather) can control the size of wildlife populations.

Decimating factors serve to offset a population's biotic potential and keep the numbers in balance with what the land base is capable of supporting. The greater the constraints, the lower the level of a particular population. Stated another way, a population may be depressed (by hunting, predators, or disease) to a level at which there are no factors limiting population growth. As the population size dwindles, environmental constraints exert less pressure on the population, and the population increases. This increase proceeds according to the species' biotic potential until such point that food, cover, or water become limiting.

### ***The Three Ds: Dispersion, Dispersal, and Density***

Wildlife do not recognize legal boundaries like humans do. Instead, wildlife move throughout an area according to the existence of natural or man-made boundaries (waterways, roads, or fences) and changes in the availability of suitable habitat. Consequently, a given animal may be present on a specific landowner's property only part of the time.

Animals tend to choose the best locations where they can find food, cover, and water. In so doing, animals

## **Patterns of Dispersion**

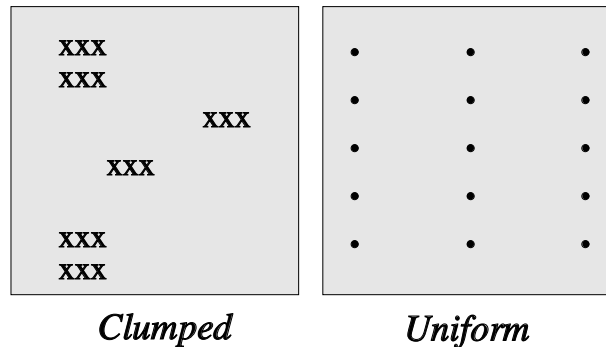

Figure 1

concentrate in numbers in some habitats at the expense of other habitats.

**Dispersion** refers to the location or pattern of animals in space, whether horizontally or vertically. The latter is often ignored but is extremely important when examining the suitability of a habitat for songbirds.

Wildlife populations distribute themselves over the landscape in two patterns of dispersion: **clumped** and **uniform** (Figure 1). All other distributions fall somewhere in between. Wildlife that form clumped distributions are often very social and live in family units. This is the most common type of dispersion because the animals are responding to the restricted availability of habitat.

Common examples of clumped dispersion include a covey of bobwhite quail; a roosting colony of starlings, grackles, or blackbirds; or a coyote family unit (mated pair, pups from current year, and possibly yearlings).

Other wildlife species, such as the groundhog, tend to be very asocial during much of the year and spread out more evenly or uniformly across the habitat (they are said to exhibit **uniform dispersion**). Very often these species are highly **territorial**. A territory is formed when an individual, mated pair, or social group of animals uses an area exclusively and actively defends this area against other members of the same species.

Regardless of the typical dispersion pattern a species takes, animals are constantly shifting around and looking for improved conditions. Thus, the pattern never remains constant. This is especially true when newborns grow and begin to move out on their own. Movement of animals from one location to a new, permanent site is called **dispersal**.

The movement and positioning of animals throughout a landscape strongly influences population **density**. Density refers to the number of animals present on a defined area at a point in time. It is an indication of how effective a particular property is at supporting a population of a particular species.

Our population estimate of white-tailed deer throughout Kansas in 1970 was approximately 50,000. A measure of density would show one deer per 16 acres.



Density is perhaps the most frequently obtained population measure and very likely the most overrated due to misuse.

When wildlife professionals discuss the dynamics of a population, they are usually referring to the changes in density that are recorded from year to year. There is a problem with using density, however, because it never remains constant. It changes throughout the year due to births, deaths, and the movement of animals in and out of the population. As a result, we are never certain that any time-specific measure of density is an accurate reflection of a population's performance.

Density is usually estimated from a count of animals on a portion of the total area. This is then expanded to the entire site. If conditions and manpower permit, all animals are observed and counted across the area, presumably without error. This is referred to as a **census** and is a more refined version of determining population size.

Often, it is just as efficient to record animal signs (droppings, tracks, vocalizations) and use this as an indication of the abundance of a species. The latter approach is called an **index** of population size. An index is easier to obtain but does not yield a numerical value for the population. It only provides a relative idea of how common the animals are on a given property (see Chapter 8).

If obtained properly, a measure of density can be a useful tool for a landowner in evaluating the success of a habitat management practice for increasing a particular species. It is important to do an index before and after modifying a site if you want to accurately measure the effectiveness of a habitat management prescription.

Care should be used to ensure that the index is obtained when: **1) the population is most stable** (not changing due to births or frequent dispersal movements) and **2) similar conditions exist** (same time of year, time of day, and weather conditions).

### ***Males and Females, Young and Old:***

#### ***What Does It All Mean?***

One of the easiest and most convenient methods of estimating or predicting population growth, decline, or stability is to measure the proportion of young to old in a population. This measure is called the population's **age ratio**. This information can then be depicted graphically in an **age pyramid** (Figure 2).

Age ratios are commonly used to compare changes in a single population between years or within the same year for different populations. State wildlife agencies have used this method to estimate increases in white-tailed deer in the past. The computer age has changed this, and new computer models and simulations more accurately predict this information.

Recent information suggests age ratios may not reflect actual changes in populations. However, age pyramids can

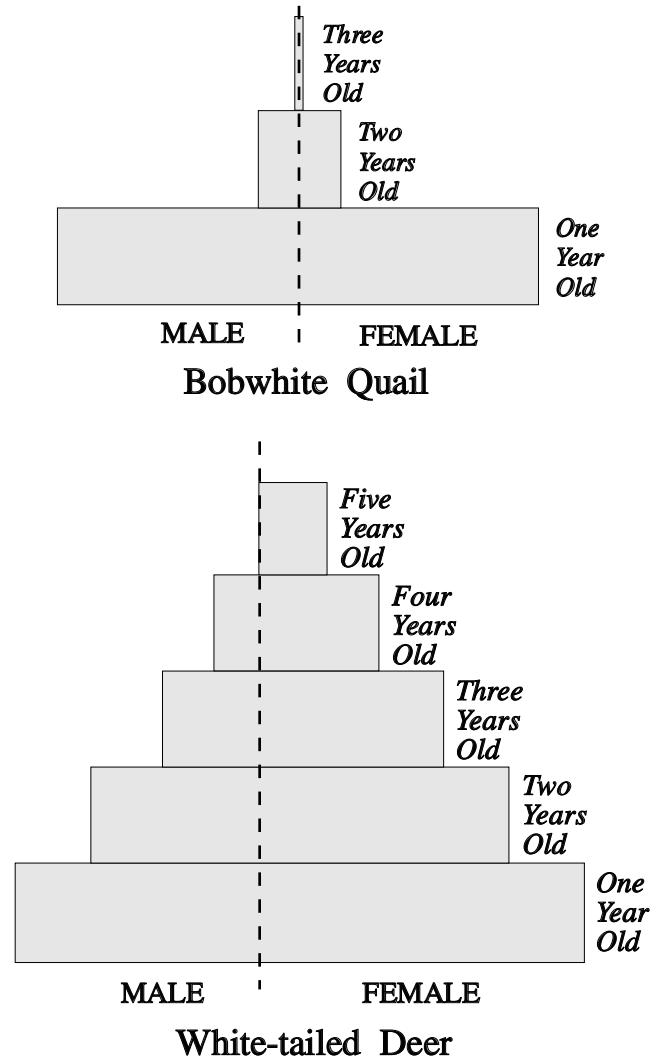
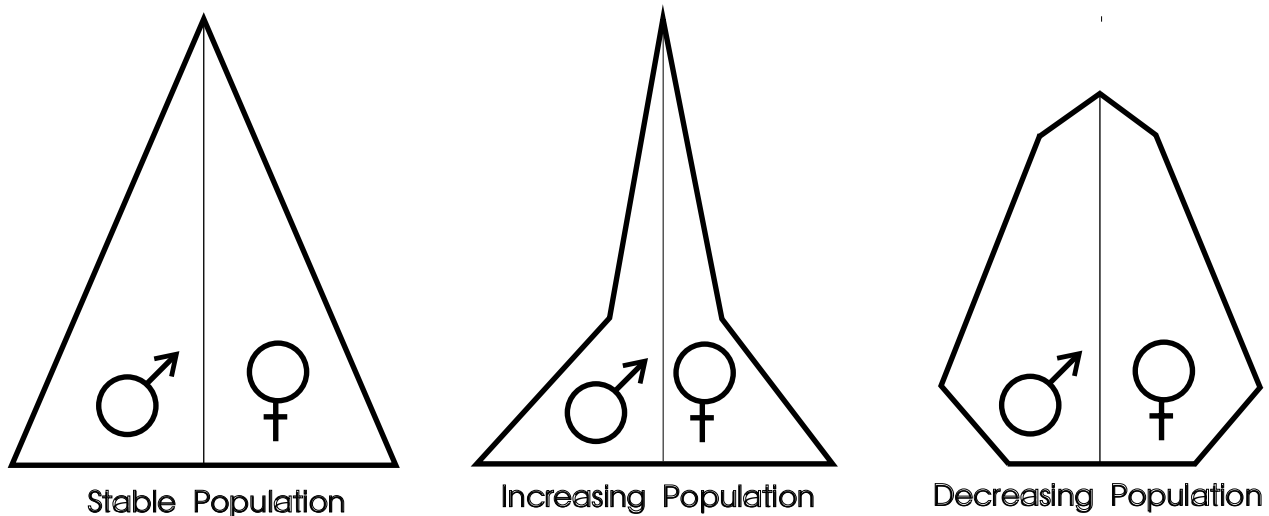

Figure 2. Age pyramid

allow a private landowner a quick look at the number of young versus old animals in the population and support several important concepts concerning the stockpiling of wildlife.

Although there can be exceptions, populations are likely to decline if they are top heavy or support a much larger number of adults than yearlings. This decline over time can be attributed to the small number of new individuals moving into the reproductive segment of the population (Figure 3). In contrast, a population that is essentially young will have a greater proportion of yearlings. Thus, the population will likely increase as maturation of the yearling class expands the reproductive segment of the population.

Assessments of population age structure are most often applied to long-lived species (white-tailed deer) and generally require extensive efforts to obtain the complete age distribution for the herd.



Age-Sex pyramid for three different populations

Figure 3

With relatively short-lived species (muskrats, quail, cottontail rabbits, pheasants, prairie chickens, mourning dove) the information is more readily obtained but will be useful only into the next year because of the high death rates and rapid turnover of the populations.

Thus, age pyramids for small game show that a large percentage of the population never makes it to age 3. The pyramid also shows that a large percentage of the population dies the first year.

This tells the private landowner that you can't stockpile small game (by not hunting in hopes of having a larger breeding population in the spring) unless there is sufficient habitat to support the animals. It also provides another important lesson: it is difficult to increase small game bird populations by stocking pen-reared birds (these birds will die over the first winter) unless the habitat is present to support a larger population. If the habitat is present, the birds will be present.

Sex ratios are another feature of populations that wildlife managers will examine carefully because a disruption in the proportion of males to females can dramatically affect the reproductive success of the population.

**Sex ratios** are most often expressed as the percentage of males in the population or the number of males per female. Sex ratio information is commonly used by wildlife agencies when managing big game herds. Agencies manipulate the ratios of bucks to does removed from the population each year in an attempt to yield the maximum number of animals that can be harvested. They must also maintain a sufficient number of bucks in the population to ensure a complete reproductive effort by does the following year.

Thus, for a **polygynous** species like white-tailed deer (one male can breed with several females), sex ratios are

skewed or shifted to favor females in a harvested population. For a **monogamous** species like Canada geese or coyotes (one male breeds with one female), a balanced sex ratio (50:50) is required for maximum production of offspring. For example, if the sex ratio is shifted to 40 males per 60 females in Canada geese, the population will exhibit only 66 percent production. In the case of a monogamous species, a sex-specific hunting season could devastate a population. However, even unharvested wildlife populations do not normally maintain an even sex ratio.

Although data do not always support the following generalizations, many studies have shown that most mammals give birth to more males than females, whereas for birds the pattern is reversed, with more females born than males. Later in life, these trends tend to move toward a more even or 1:1 ratio.

### ***Mortality: The Other Side of the Equation***

Common to all living creatures are the events of birth and death. Few, if any, animals in the wild die from old age. Instead they succumb to one of many factors that affect the members of their particular species. Mortality refers to the inherent loss of individuals from a population through death. Mortality is difficult to measure because carcasses are hard to locate. Animals that disperse or move out of a population have a fate that can seldom be determined.

Consequently, it is more practical to measure **survivorship**, or the numbers of animals remaining alive, as these individuals can be located and accounted for. Wildlife species with a high biotic potential, such as cottontail rabbits, tend to have low survivorship and high mortality at younger ages, thus offsetting their high

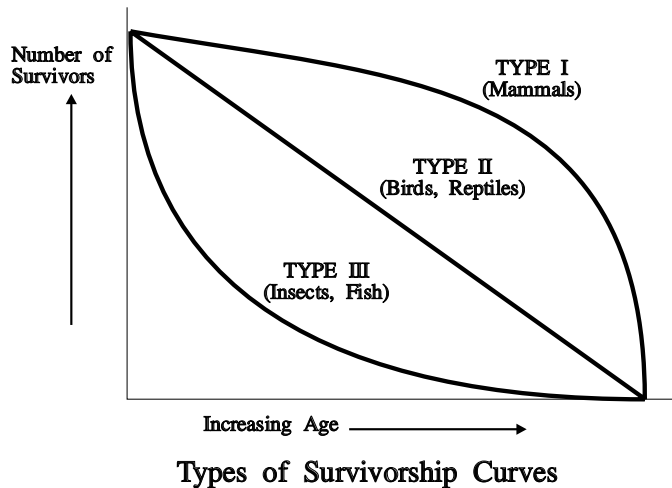

Figure 4

reproductive outputs (Figure 4). Animals with a lower biotic potential, such as white-tailed deer, have higher survivorship of young, compensating for the smaller litter sizes.

Frequently, survivorship values or rates are obtained from field data for all age classes in a population. From these values, survivorship curves can be developed for a specific population. These are used to assess the population's potential for growth or decline in a particular habitat.

Only one mortality factor (disease, predation, exposure to severe weather, starvation or malnutrition, accidents, or harvest) can be the proximate cause of how an individual animal meets its fate. While the proximate cause may be predation or exposure to severe weather, the ultimate cause may be related to a lack of sufficient cover to escape predators or the effects of adverse weather.

A population will be subject to many factors over time to produce an overall reduction in population size. Because habitat conditions, weather patterns, and populations of predators and prey are constantly changing, some factors that have a significant impact in one year may be less so the following year. Despite these inconsistencies, in many cases the overall reduction in population size from mortality factors across years remains the same.

In effect, the specific causes of death tend to balance or compensate each other. Wildlife professionals call this phenomenon **compensatory mortality**. Stated another way, one type of mortality largely replaces another kind of mortality in animal populations while the total mortality rate of the population remains constant.

Let's try to clarify this point with an example. Bobwhite quail have great difficulty surviving difficult weather conditions at the northern limits of the species' range. When winters are extremely cold, many animals die from exposure, and fewer animals will be taken by

predators, such as great horned owls. During mild winters, many quail survive only to fall prey to great horned owls because of finite amounts of escape cover. The overall effect is that approximately the same number of quail are supported by the habitat from year to year. Thus, the habitat determines the number of animals that can survive in a population, or animals produce a "surplus." This surplus is removed by mortality.

Perhaps a more specific example with bobwhite quail using numbers will clarify the point further. Let's assume that total mortality on a bobwhite quail population is 70 percent (70 percent of the total population will die in the first year; remember the example from age-ratio section). In the first year when the weather is severe, 20 percent of the population is lost to the great horned owl, and 50 percent of the population dies from exposure. The total mortality rate for the population is 70 percent.

In the second year when predation by great horned owls removes 60 percent of the population, only 10 percent of the population is lost to exposure for a combined total mortality rate of 70 percent.

Wildlife managers employ the concept of compensatory mortality when establishing hunting and trapping regulations. Hunting and trapping serve to replace the natural mortality factors operating on a population and keep the density in balance with what the habitat can effectively support.

In the quail example, the population was hunted, and 30 percent of the population was removed. In this situation, great horned owls removed 10 percent of the population, and 30 percent of the quail died from exposure. The total mortality rate remained unchanged at 70 percent.

The portion of a wildlife population that is capable of being removed or culled is called the **harvestable surplus** (that portion of the population that would invariably die from other causes). Data suggest that species with a high biotic potential can have a larger percentage of the population harvested in any one year than species with a low biotic potential because their higher reproductive outputs will replenish the loss of animals more quickly.

Muskrats are a perfect example. When large numbers of muskrats are removed by trapping, the population responds in these ways:

- *the length of the breeding season is increased so more litters are produced,*
- *the number of offspring produced per litter increases,*
- and*
- *surviving muskrats are less susceptible to disease or predation.*

Regardless of which species we are talking about, man must regulate the removal of animals because all populations have a harvest level at which the mortality factors are no longer compensatory but **additive**. This

means one kind of mortality is added to the other sources of mortality.

Additive mortality can be detrimental and lead to population decline. Back to the quail example: we know approximately 70 percent of the population will die every year, whether we hunt the population or not. If hunting pressure is heavy and a large percentage of quail are killed, pushing the total mortality above 70 percent, this would be considered additive mortality.

**One important note:** *regulated sport hunting has never resulted in a species being placed on the endangered or threatened species list. Commercial, market, or unregulated hunting may have contributed to the extinction of a wildlife species.*

### What Keeps Animal Populations in Check?

Up to now, we have discussed a variety of concepts that describe some facets of wildlife populations. We have yet to address the underlying theme behind population management: the concept of **carrying capacity** (Figure 5).

On any one particular tract of land, there will be a unique array of vegetative cover types and landforms that are arranged in a given pattern and provide habitat for some wildlife species. An individual animal must find food, cover, and water within reasonable proximity to survive on that tract of land.

The spatial arrangement and quality of these particular requirements will ultimately determine how many members of a species can exist on the property. This is a simplified version of carrying capacity (the maximum number of animals an environment can support under stable, steady conditions without causing destruction of the habitat).

Over the period of a year, a population will experience births, deaths, and movements of members into and out of the area. All of these properties of a population are related to a greater or lesser degree to habitat suitability.

Habitat quality serves to regulate or maintain the population at fairly stable numbers from year to year. As the habitat is manipulated or permitted to slowly change on its own, the carrying capacity of the area will become different. Subsequently, the population will respond with an increase or decrease in size. Such changes are predictable but usually only in a very coarse manner.

Problems can and do arise, however. Disease outbreaks

or drought, for example, can seriously deplete population numbers. It may take several years to restore the population to its original density. When such catastrophic events occur, few populations of wildlife have the capacity to withstand them.

As a final comment, it should be noted that some forms of wildlife tend to track or stay fairly close to the carrying capacity set by the habitat. Other species fluctuate widely about the habitat set-point. This sometimes depends on how much of the landscape has been changed by man. Knowing ahead of time how your species of interest is likely to respond to habitat alteration is one of the keys to successful management.

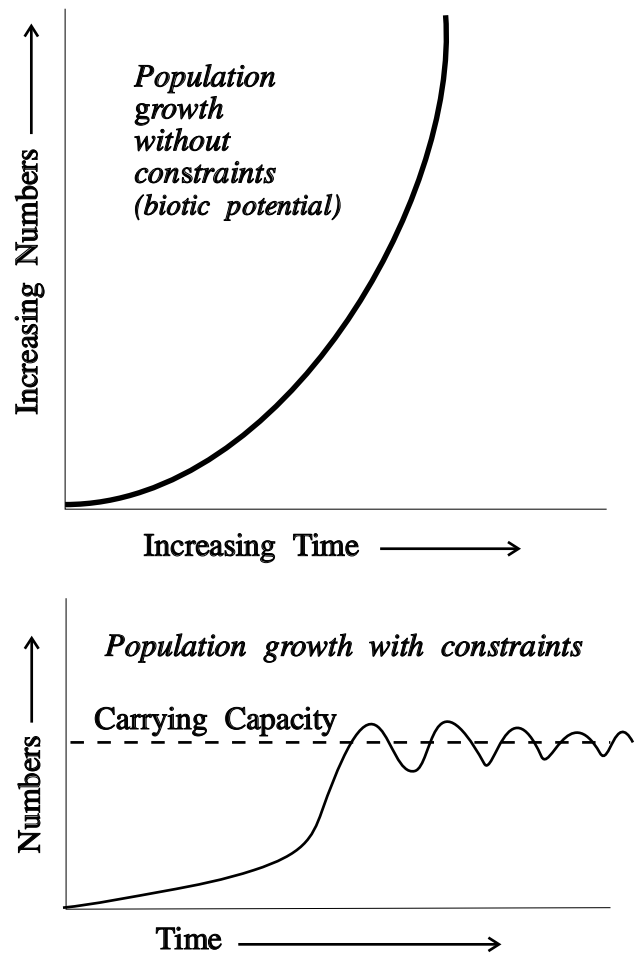

Figure 5

## Questions for Chapter 5

1. What is a population, and why are wildlife biologists concerned with population dynamics?
2. What is an animal's biotic potential?
3. What is a limiting factor? Why is it important to know a particular limiting factor?
4. What is the difference between a limiting and decimating factor?



## Chapter 6

# Inventory, Goals, and Guidelines: The Process of Managing Wildlife

Thomas G. Barnes

Most people enjoy seeing wildlife on their property and in the wild, and most of us relate to animals as individuals. Many of us have had the experience of viewing deer in a clearing, seeing birds at a feeder in the backyard, or nursing an injured animal back to health. However, this individual approach to animals can be a major stumbling block in explaining wildlife management to the general public because the viability of wildlife depends on populations, not individuals (see Chapter 5).

Despite this individual approach to wildlife, a landowner must come to accept the larger view of wildlife management and try to manage wildlife populations so that animals are sufficiently abundant to meet specific goals. The key factor in assuring healthy wildlife populations on your property is to have a well-defined plan of action that encompasses specific goals.

## *Goal-Oriented Wildlife Management as a Part of Total Resource Management*

The purpose of this chapter is to introduce you to the idea of goal-oriented wildlife management as it relates to “Total Resource Management” and to provide some general guidelines for you to begin the process of managing wildlife

on your property (Figure 1). The concept of goal-oriented wildlife management is governed by certain guidelines that include:

- 1) *Inventory the land and wildlife to assess the potential for meeting desired management objectives.*
- 2) *Determine your management goals and objectives.*
- 3) *Determine if adequate physical, financial, and human resources are available for meeting the desired management objectives.*
- 4) *Manipulate the habitat or population to meet the desired management objectives.*
- 5) *Evaluate the program to assess the effectiveness of the manipulations and modify them if they are not producing the desired results.*
- 6) *Follow up with a re-evaluation.*

The best plan of action to provide good wildlife habitat and healthy wildlife populations is to manage your farm/ranch by “Total Farm/Ranch (Resource) Management.” This concept involves managing all areas of your farm/ranch: the woodlot, pasture, cropland, livestock, and wildlife as an integrated whole.

Thus, you must have an idea of general farm/ranch management before beginning to manage with the goal of

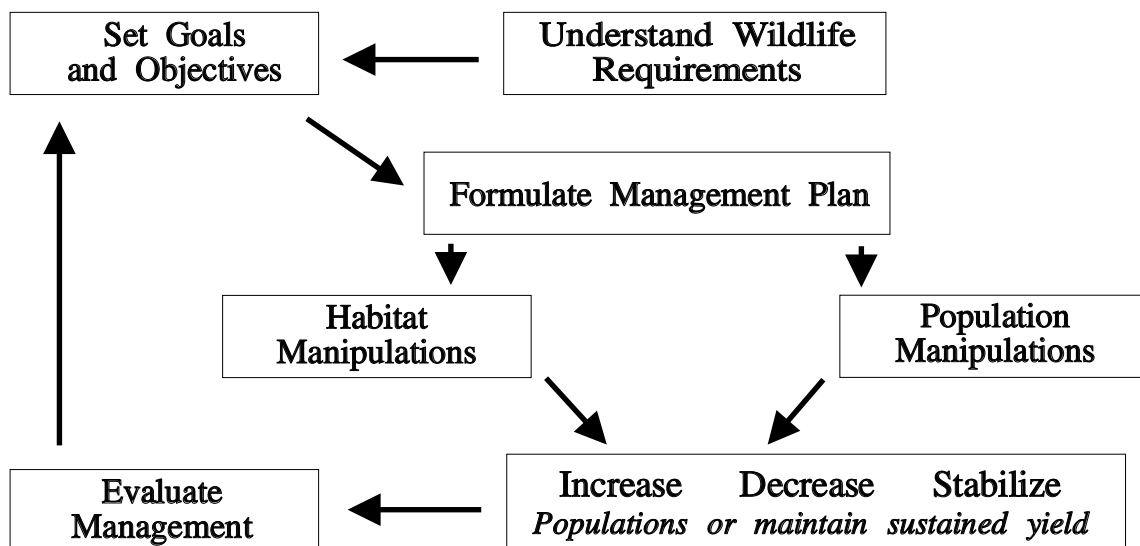

Figure 1

promoting a particular species or variety of wildlife. This is important because proper forest harvesting or thinning (see Chapter 18) can provide economic returns as well as a habitat for certain species of wildlife.

On cropland areas, total farm management may include conservation tillage or implementing grassed waterways or contour farming. It may be as simple as deciding what type of crop to plant and how to rotate crops (see Chapter 19).

Total farm/ranch management for pastures may include implementing some type of a rest-rotation grazing system (see Chapter 17). An integrated farm management system may also include a wildlife-for-profit venture (see Chapter 22). By managing the whole farm wisely, you can ensure greater sustained economic returns to benefit both you and the wildlife. Attempting to manage without a plan generally produces poor results.

When considering wildlife management in your farm/ranch plan, you need to consider what activities will fit into your general farming or ranching operation. Many landowners choose to manage in order to attract an interesting mixture of wildlife according to their likes or dislikes. Others may choose to manage for one particular species, such as white-tailed deer or bobwhite quail.

Landowners must realize that wildlife management, as a part of the total farm/ranch management, takes time and requires a long-term commitment. Similarly, landowners should not expect wildlife populations to increase overnight. A degree of patience is required, and if the proper habitat is present, eventually the wildlife species adapted for that habitat will respond.

### ***Where Do I Begin?***

The first step in developing a wildlife management plan is to inventory your land and wildlife to determine what resources are available to work with. Building on what is already present is better than starting from scratch.

Begin by learning as much as possible about what general types of soil and habitat are present on your farm/ranch. An inventory will reveal the quantity and quality of wildlife habitat on the farm/ranch. Also, an inventory will reveal what kinds of wildlife and how many of each species are present on your property (see Chapter 8).

- *Is your property largely cropland, rangeland, or a combination?*
- *Are there any ponds or wetlands located on the farm/ranch?*
- *What type of farming operation do you have? Is it small grain, row crop, hay?*
- *What type and numbers of livestock are present?*
- *What type of rangeland do you have? What grass species are present? What is the range condition of the stand?*

Because your goal is to manage the population, it is equally important to identify habitats on neighboring

property. Rarely will one landowner in Kansas manage large enough acreage to provide everything a wildlife population requires. While most resident wildlife species do not travel more than one-quarter to one-half mile in their lifetime, populations require substantially more space. Thus, to properly manage white-tailed deer or wild turkeys, 1,000 acres or more would be required to support a healthy population.

Therefore, it is imperative that you examine neighboring lands to determine which management practices will be necessary on your land. For example, an inventory may indicate your farm has 10 acres of mature oak-hickory forest and 600 acres of corn and soybeans, whereas your neighbor's property is largely rangeland which is overgrazed.

If you are managing for deer based on this inventory, you may want to convert some of your cropland into young forest because neither you nor the neighboring property is providing for that need.

Once you have completed the inventory, you need to create a planning document or map delineating existing habitat types, soil types, croplands, fencerows, marshes, streams, ponds, buildings, roads, etc. The best method for creating this planning document is to create a sketch map based on an aerial photograph and soils map of your farm and adjoining lands. Because this is such an important step in the process, creating a planning document will be covered in the next chapter.

### ***Who Can Help?***

At this point, it would be very useful to contact a technically trained individual to help you in developing a habitat plan. Do not automatically assume an individual with "wildlife" printed on a business card has the credentials necessary to assist you in developing a management plan.

You can obtain the best wildlife management information from your district wildlife biologist, Kansas Department of Wildlife and Parks; the Wildlife Extension Specialist at Kansas State University; the Soil Conservation Service (SCS) wildlife biologist or district conservationist; a district service forester with the Kansas State and Extension Forestry; or a wildlife consultant certified by the Wildlife Society.

When looking for professional advice, be aware that anyone who stands to benefit from a crop, beef, or timber sale may have a conflict of interest. Be especially wary when presented with a plan that lists numerous wildlife benefits as a result of certain management practices but fails to list the losses and trade-offs associated with those practices.



## Setting Goals and Objectives

Once you have inventoried the land and wildlife, it is time to set your goals and objectives. This is an important step in directing your efforts toward what you want to accomplish on your property. Remember, you want to set realistic goals and objectives that are part of an integrated ranch or farming plan for your wildlife enterprise.

You cannot separate a good, long-range farmland use plan from soil conservation, water conservation, wildlife conservation, or forestry. Each complements the other and reflects the overall value of the land and the owner's concern for stewardship. Often, wildlife objectives may be one of the following:

- 1) *managing for the greatest variety (diversity) of wildlife species.*
- 2) *managing for one or more game species, such as deer, turkey, pheasants, bobwhite quail, cottontail rabbits, squirrels, etc.*
- 3) *managing for abundant game for hunting.*
- 4) *having abundant wildlife for non-hunting activities, such as bird-watching, photography, etc.*
- 5) *deriving income from hunting, trapping, fishing, or other recreational use of the farm/ranch as it fits into overall farm resource management.*

While setting goals and objectives seems like a simple process, it is actually very complex and constantly changing. Your objective may be to maintain a viable deer population within the farm boundaries. But to what extent do you want:

- *to increase or decrease numbers of deer present on the farm?*
- *to maximize numbers of harvestable trophy bucks?*
- *to maximize harvest of surplus deer?*
- *to maximize economic return from the deer herd?*
- *to maximize quality of the deer habitat?*
- *to minimize damage to agricultural crops?*
- *to maintain sufficient numbers of deer for aesthetic reasons?*
- *to attract tourists?*

Most goal- or objective-oriented management systems include a number of goals that are arranged by priorities and reviewed periodically. You must be able to attain these goals with the physical, financial, and human resources available. Planning and goal-setting is a continual process in which results of your first decisions influence all subsequent operations.

The best strategy is to begin with what Mother Nature provided and plan carefully from the beginning. As the plan unfolds, treat it as a living document, continually monitoring results and making changes as necessary.

## Limitations to Consider

When establishing your goals and objectives, keep the following factors in mind:

- 1) *What is my land's natural capacity to produce wildlife?*
- 2) *What wildlife species are present on my land?*
- 3) *What capacity do the adjoining properties have for producing wildlife, and what species are present on that land?*
- 4) *What are the trade-offs associated with management?*

The land's capabilities and the wildlife species present define the limits of management possibilities. Depending on ranch or farm size, conditions found on neighboring property may be very important in setting realistic goals. Species that require several hundred acres may range on and off your property, so habitat on your neighbor's property is important also. If you desire to manage for big game, uniting several farms is an alternative.

The amount and kind of habitat on your property for various wildlife species is a very important consideration. It is not possible to manage for prairie chicken or pronghorn antelope if you have no grasslands. Keep in mind that it is much easier to manage for wildlife species already present, even if their numbers are low. When a species does not exist on a site, its absence is a good indication that intensive and long-term management will be required.

Other activities conducted on your area will also affect wildlife species. Try to anticipate those effects when making your management plans. In combining ranching, agriculture, and wildlife management, you can usually improve the wildlife habitat. However, for excellent wildlife habitat, you may need to modify these practices to some extent or add other practices. The degree of management practiced and any trade-offs in ranching, agriculture, or wildlife values must be the owner's decision.

Agricultural management activities affect wildlife in one way or another. In most instances, these effects help some wildlife species, but may harm others. You need some understanding of these effects to make realistic goals and objectives. For example, and as a general rule, crop harvest benefits wildlife species that derive food and cover from low-growing plants. These species may include deer, rabbits, and bobwhite quail. On the other hand, timber harvest or clear-cutting can harm some forest wildlife species like barred owl or squirrels that require mast-producing hardwoods (Hardwoods produce **hard mast**, such as acorns or hickory nuts).

Likewise, you need to know the habitat requirements and life history of the wildlife you intend to manage. For instance, if you desire prairie chickens, you should know that prairie chickens require unbroken blocks, at least 160 acres minimum of vegetation in perennial forbes and grasses, and flat to gently rolling terrain with some mixing of cropland. Croplands are not necessary but can and do furnish important foods.

**Table 1. Partial listing of habitat management prescriptions.*****Setting Back Succession***

Timber harvest  
 Selection cut  
 Clearcut  
 Shelterwood cut  
 Thinning  
 Mowing (bush hogging)  
 Brush control (roller chopping, root plowing)  
 Controlled burning  
 Herbicide treatment  
 Livestock grazing management  
 Edge feathering  
 Strip disking (plowing)

***Advanced Succession***

Construct wildlife watering areas  
 Construct brushpiles  
 Construct nest boxes, platforms, or islands  
 Plant food plots  
 Plant trees and shrubs  
 Plant grasses and legumes  
 Eliminate fall plowing  
 Delay spring plowing

Once these initial steps have been completed, it is now time to decide how you need to manipulate your property (Table 1). The later sections of this course discuss the life history requirements of many Kansas wildlife species, and what types of manipulations are required to achieve optimum habitat for each species (Chapters 27 through 35).

As you continue reading, certain management options will suggest ideas. Refer to your management plan, list the work to be done at each site, and describe in detail what needs to be accomplished. Remember to continually monitor the results of your plan and modify the plan as necessary.

***Costs and Benefits of Managing Wildlife*****Costs**

Most of the costs of managing your farm for wildlife will be indirect. This indirect cost may come as a reduction in potential income from the sale of livestock or other agricultural crops. This cost may be slight to significant, but in most cases it will not be excessive. Costs can be calculated by forecasting timber and agricultural yield from various management options under your total resource management plan.

Direct costs of wildlife management come from added management practices. Examples of direct costs include planting food or cover crops, pruning or release cutting of fruit and mast-bearing trees, and putting up nest boxes.

Other costs may include prescribed burning, mowing, liming, fertilized plantings, or seeding of logging roads.

Direct costs usually are not great, since the number of practices carried out is small compared to the size of the area managed. Several governmental agencies can help you with recovering some of your direct costs. Contact your local Kansas Department of Wildlife and Parks district wildlife biologist or the SCS and ASCS for information on cost-sharing arrangements.

**Benefits**

Just as much of the cost of wildlife management is indirect, so are many of the benefits and values of wildlife. Whether or not we realize it, all human beings benefit from wildlife, either directly or indirectly. Unfortunately, much of the American public is unaware of the contribution that wild plants, animals, and habitats make to their lives. Perhaps the most important value a landowner obtains from managing his/her land to its full potential is personal satisfaction, and the knowledge gained from good stewardship. The value of wildlife and their habitat is often a difficult entity to measure or categorize.

The following discussion is based on the work of R. T. King, who cataloged wildlife values as:

**1) commercial, 2) recreational, 3) biological, 4) social, 5) aesthetic, and 6) scientific.** King chose to concentrate on essentially positive values, but wildlife can also fall into a seventh category, negative values.

**Commercial Value**

A commercial value has been assessed to wildlife when:

- *an animal (plant) or product from a wild animal (plant) is sold or traded, or*
- *a business has been created which uses, or is based on, access to wildlife populations.*

It is illegal for an individual to sell wildlife or their products directly because they are public property. Commercial value is usually measured in dollars and includes the sale of wild game from deer farms, commercial fisheries (including marine fish and shellfish as well as fresh water fish), or furs harvested. For example, the Kansas Department of Wildlife and Parks reported during the 1986-87 trapping season that Kansas trappers sold more than 137,000 furs at a value of \$1.94 million.

**Recreational Value**

Hunters, fishermen, bird-watchers, photographers, hikers, campers, and tourists of all kind derive benefits from encounters with wildlife. Enjoyment of wildlife and the money expended is termed a recreational value.

The 1985 National Hunting and Fishing Survey indicated 77 percent of the American public 16 years of age and older (167 million people) participated in outdoor

activities involving fish and wildlife during 1985. They spent more than \$55.6 billion. Hunters spent \$10.1 billion, fishermen spent \$28.1 billion, and appreciative participants (bird-watchers, photographers, bird feeders, etc.) spent \$14.1 billion.

The Kansas statistics are just as impressive. Approximately 1.6 million Kansas residents 16 years of age and older participated in some form of wildlife recreation. They spent more than \$229 million for fishing, \$74 million for hunting, and \$68 million for other wildlife-related activities. Hunters are also willing to pay for the privilege of hunting, fishing, or other outdoor recreational activities on private lands. This may be an added economic value for the private landowner and is discussed in Chapter 22.

### Biological Value

Wildlife are integral parts of biological communities and ecosystems. This contribution to productive ecosystems has been termed biological value. Each animal and plant is a unique genetic and chemical factory that has taken centuries to develop.

These genetic and chemical secrets have allowed man to develop medicines and pharmaceutical products to cure common diseases. Most of our agricultural crops (soybean, corn, milo, wheat, etc.) and domestic livestock originated from wild ancestors.

Other important services rendered by wildlife include, but are not limited to:

- 1) *pollination of agricultural and wild plants,*
- 2) *seed dispersal and planting,*
- 3) *natural population control and regulation of numerous pest species (not only insects but also vertebrates like mice and rats), and*
- 4) *nutrient transport and recycling in natural systems (man does this artificially in agricultural lands).*

### Social Value

How do you measure the quality of life and the benefits of wildlife in the community setting? Why do rural communities attract doctors, lawyers, teachers, and other professionals? Perhaps it is because wildlife have a value which the community recognizes as beneficial.

Perhaps smaller communities can attract professionals because they have access to hunting, fishing, or other outdoor-related activities. Thus, social value is the value the whole community derives from the use of wildlife or the values of organizations (such as a local hunt club) that were created because of a common interest in wildlife.

### Aesthetic Value

What effect does seeing a flock of wood ducks dipping through the local swamp at sunset have on the human spirit? What feeling did you get when you sighted your first white-tailed doe with two white-freckled fawns following behind? In your den or living room do you have photographs or artwork depicting a wild scene? These are

aesthetic values which possess beauty or historical significance, inspire literature, art, poetry, and music.

To those who do not depend on wildlife directly for their livelihood, these are perhaps the most important values, and they are priceless. As Aldo Leopold so succinctly stated in *A Sand County Almanac*, "There are some who can live without wildlife and some who cannot." Wildlife management obviously appeals to those who cannot live without wildlife.

### Scientific Value

Where would our society be without:

- *the discovery of penicillin,*
- *bacteria isolated from armadillos that is useful in vaccinating humans against leprosy, or*
- *chemicals that may hold the key to a cancer cure because they are extracted from certain snails and mollusks that do not get the disease?*

Some of the advantages of studying wildlife and their habitats include:

- *extending our knowledge about natural biological control of pests,*
- *learning how humans behave by studying primate behavior, or*
- *finding out how our health can be endangered by pesticides such as DDT.*

In addition, wildlife are used in schools, nature centers, and parks to enhance people's understanding of the environment. Thus, scientific values are those which extend our information base.

### Negative Value

There are negative values associated with wildlife. Some species may become pests and destroy property or agricultural crops. Deer, voles, and birds can become a problem in orchards. Roosting blackbirds may become a nuisance and health hazard when concentrated. Coyotes may kill some livestock. Deer may pose road hazards to vehicular traffic. All of these examples represent negative wildlife values.

### Summary

The following general principles are important points to remember when managing wildlife as part of "Total Resource Management." They are statements which you should think about when considering the prospect of managing wildlife.

**1. *If wildlife populations are to survive, it is largely due to management of populations on private lands.*** The private landowner is the most important factor in the future success of wildlife.

Stewardship of the land will determine the abundance of wildlife in years to come. You do not own the wildlife; the wildlife are public property. In addition, you do not

own your land in the absolute sense; rather, you have been given temporary ownership of the land for a finite period of time. How you take care of the land will affect all future generations.

**2. *There is no such thing as a free lunch.*** For every action, there is an equal and opposite reaction. There will always be trade-offs. Are you going to manage for diversity of species? If you cut your timber, how will this affect your squirrel population? If you plow and plant that 10-acre area with wheat, how will that affect your quail population? If you do not hunt your deer population, how much damage can you tolerate in your soybean crop?

**3. *You do not work or live in a vacuum.*** All living things are related. By killing that coyote, red fox, or rat snake, you have destroyed one of nature's most efficient mouse traps.

In addition, unnatural changes in the environment can produce unexpected and long-term effects. If you spray a pesticide to destroy an insect or plant pest, will it reach the stream and destroy fish, frogs, or mussels? Even though DDT has been banned in this country for years, it is still affecting some of our wildlife species. Remember that what you do on your farm or ranch affects your family and your neighbors, near and far.

**4. *There are certain restraints under which you must operate.*** No one suggests that you manage wildlife to the point at which you cannot make a comfortable living. We all have financial, physical, and human restrictions.

You must also operate under the constraints that federal and state agencies impose on us. You can harvest deer, prairie chickens, turkeys, quail, etc. only during certain periods of the year. For many species, you can harvest only a limited number daily. Some species you cannot hunt, trap, or harvest at all; you can only enjoy their presence.

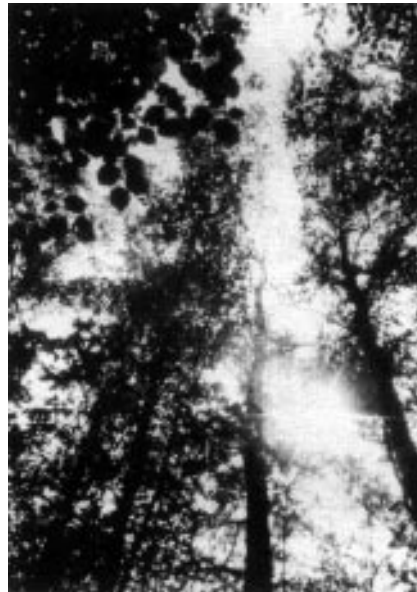

## Questions for Chapter 6

1. What is goal-oriented resource management?
2. What are the steps in developing a wildlife management plan on your farm/ranch?
3. Who can provide assistance with creating a wildlife management plan for your farm/ranch?
4. What are some of the limitations and trade-offs of managing wildlife on your farm/ranch?

### Questions for Chapter 6 (continued)

5. What are the benefits of managing wildlife on your farm/ranch?

6. List the goals and objectives for managing wildlife on your property.

Name \_\_\_\_\_

## Chapter 7

# Aerial Photographs, Maps, and Habitat: Creating a Planning Document

Thomas G. Barnes

Wildlife and natural resources management can be complicated, and it is always a long-term process. Rarely will a landowner have the available resources to complete all management or habitat prescriptions in a single year.

Thus, management activities are spread over a period of years coinciding with the amount of financial, physical, and human resources available to a landowner. For these reasons, management plans are developed and used to guide management activities or manipulations toward landowner objectives. A good management plan directs future activities in an ordered fashion so that benefits and costs are predictable and follow landowner objectives.

Management plans must account for existing conditions, the potential for changing or maintaining them, and the probable results of proposed activities or prescriptions. To be valuable, they must carefully examine the resources to be managed. This information provides the basis for recommendations about what actions landowners should take to reach desired goals. Analyses of costs and benefits make management plans more meaningful.

A good natural resources or wildlife management plan should include the following:

- 1) *statement of goals and objectives,*
- 2) *constraints (financial, physical, human) for the property,*
- 3) *maps identifying location, boundaries, natural features, and timber types,*
- 4) *maps of soil types and their capabilities,*
- 5) *habitat management prescriptions with schedules for carrying them out,*
- 6) *financial analyses and information on costs/benefits,*
- 7) *explanatory attachments describing specific practices or environmental concerns.*

This chapter examines how you develop the map into a dynamic planning document.

The best planning map is one based on an aerial photograph of your farm and adjoining lands. (Aerial photographs and soil survey maps may be obtained from your county Agricultural Stabilization and Conservation Service [ASCS] office).

The best approach to drawing a cover map (showing different habitat types) of your farm is to lay a piece of tracing paper directly over the aerial photograph. Using a dark

blue or black ink pen, trace around the perimeter of the farm.

The next step involves tracing every definable item on your farm, including buildings, roads, streams, ponds, fields, woodlands, idle acres, wetlands, fencerows, hedgerows, pastures, orchards, and any special features of the farm (Figure 1). This document will now serve as the basic cover map of your farm. It is wise to make several copies or reproductions of the original map to facilitate any alterations that arise during the rest of the planning process.

Once you have completed the basic map, number or label each habitat type, all buildings, streams (including direction of flow), woodlands, etc. On a separate sheet of paper provide a detailed description of any idle areas, wetlands, pastures, and rangeland tracts.

Many landowners may seek professional assistance and management advice from the Kansas Department of Wildlife and Parks—technical guidance program for private landowners, Wildlife Habitat Improvement Program (WHIP), or the Kansas State and Extension Forestry—technical guidance program for private landowners, Forest Stewardship Program.

Creating a written description of the natural habitats present on the farm will help the biologist make on-site habitat recommendations or prescriptions. The more specific information you can provide about the woodlands, soil types, pastures, fields, idle acres, and ponds, the more it will help the biologist. If possible, describe what types of grasses, legumes, broadleaf weeds and flowers (forbs), and shrubs are in the pastures or idle areas and the crop rotations used in agricultural fields. For example, your pastures may be dominated by big bluestem, and an idle area may be full of blackberries, sumac, eastern red cedar, and broomsedge.

The delineation of timber types is a major feature on maps drawn for forest management. Each stand should be outlined and labeled for easy reference. Stands with similar characteristics may be labeled the same and combined for management purposes, especially if similar stands in different locations on the tract are small. Verbal and written descriptions should contain as much of the following information as possible:

- 1) *the kind of trees making up each stand;*
- 2) *the range of ages represented by the majority of trees in the stand;*

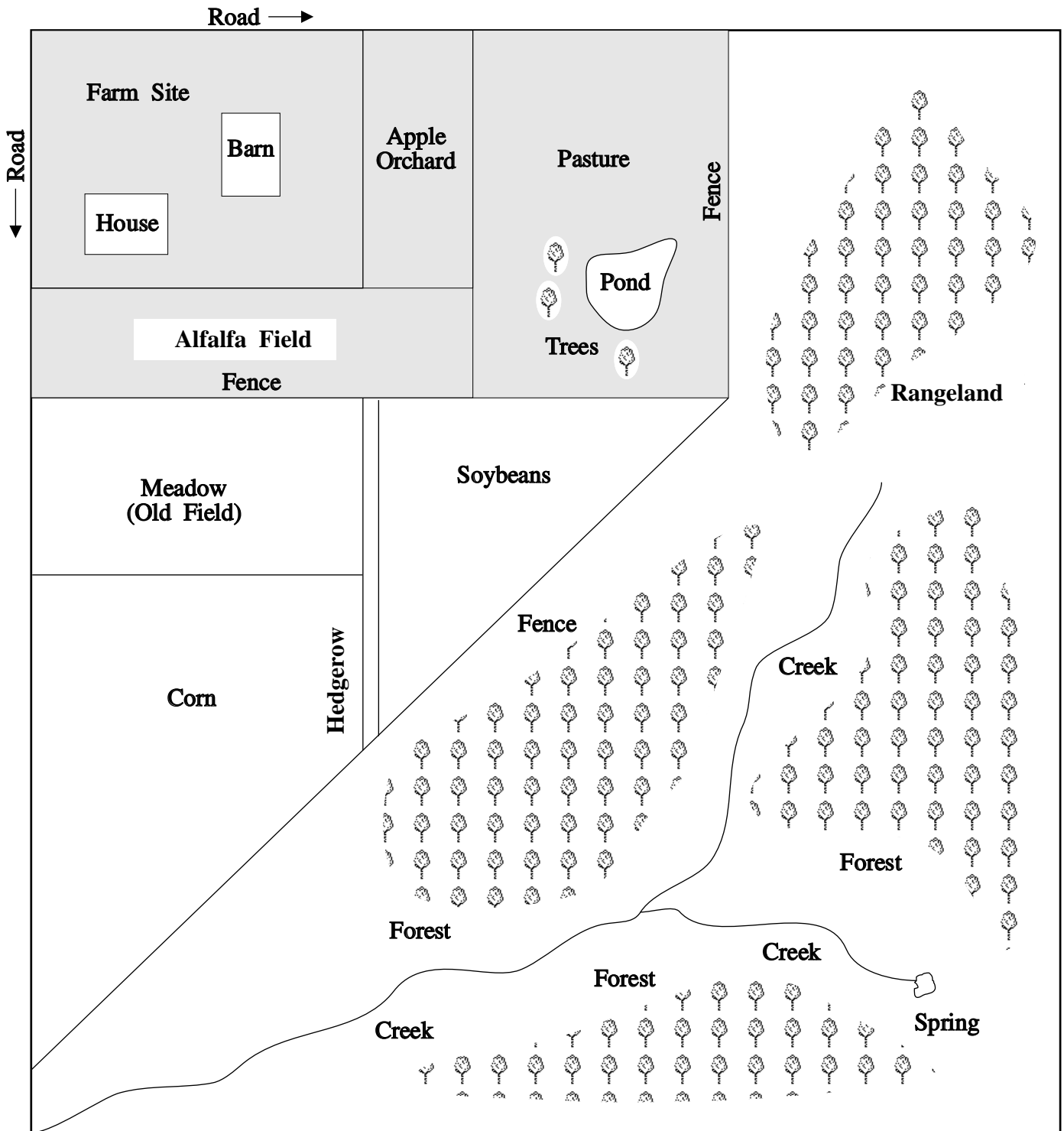

Figure 1

- 3) the biggest and smallest diameters of trees present;
- 4) a site index of preferred species (quality of the site, its ability to produce timber suited for the site's conditions);
- 5) the amount of merchantable timber;
- 6) the number of snags, deformed, rotten, broken, or otherwise poor trees;

- 7) whether there are infections or insect pests present in each stand;
- 8) a description of soil characteristics (sandy, loamy, heavy clay, poorly drained);
- 9) how steep the site is and in what direction it slopes;
- 10) when and how the timber was last cut.



### TEN YEAR PLAN

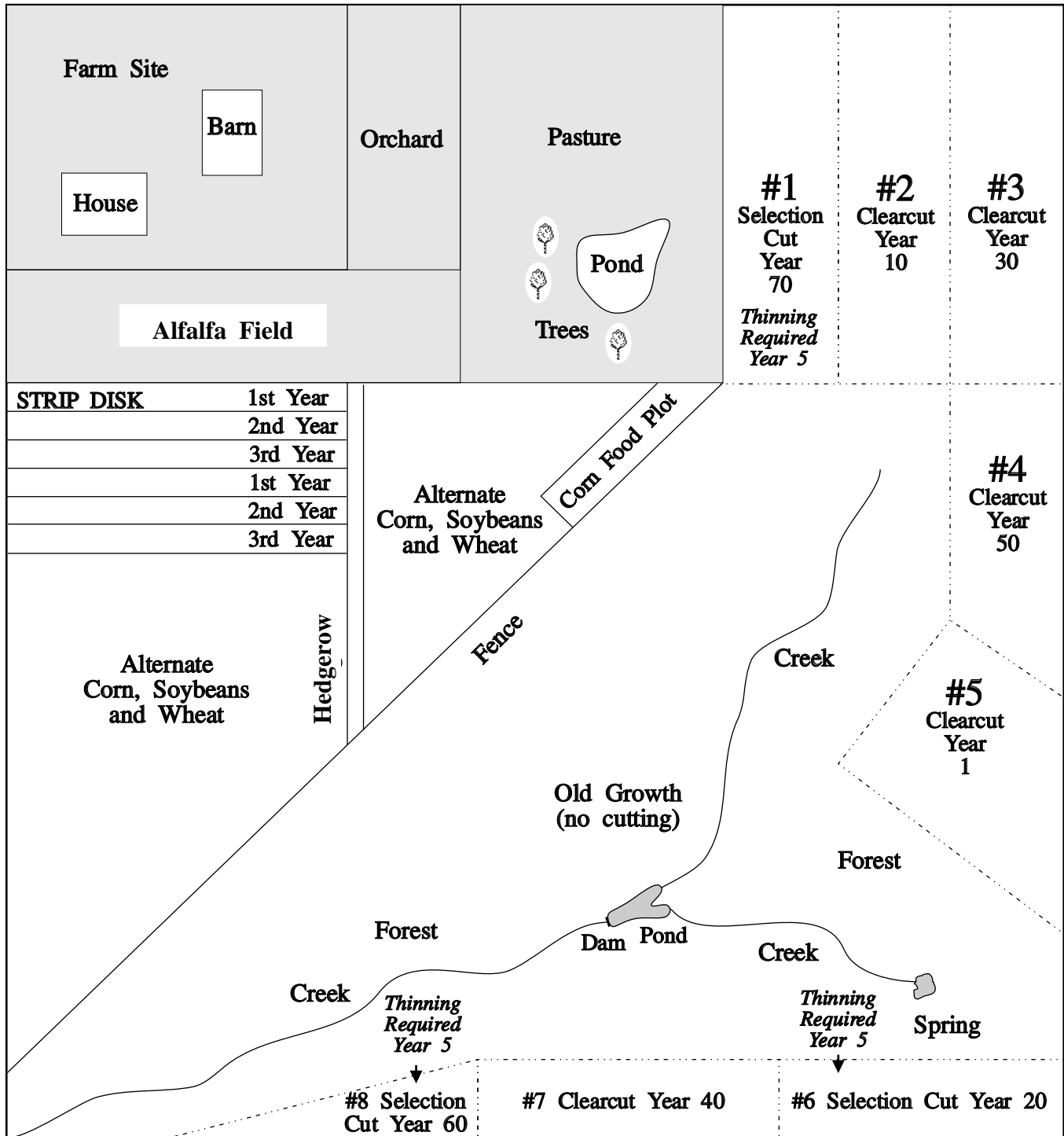

Figure 2

The final item to identify on the planning document is any area of special environmental concern. To maintain water quality, for example, special treatment along streams, ponds, or lakes is recommended. Where specific multiple-use considerations are part of the landowner's objectives, any practices specially included in the plan should be highlighted.

The time covered by a management plan will vary, according to the complexity and specific circumstances involved. Usually a plan will cover at least five years, but plans to regulate a forest over a rotation could provide general guidance for several decades.

Longer-term plans must provide for updating and alterations. Flexibility in both scheduling and practice is necessary to reflect changes in conditions and landowner preferences. Landowners need to understand that, as situations change, they may need to make radical alterations in the prescribed activities. Usually the more time the document covers, the more likely changes will be needed.

Documentation of every activity done on the property, whether in the original plan or inserted later, becomes a part of the complete records. Such records, besides being important for management decisions, are necessary for tax purposes. This information provides a measure of the plan's success and a basis for adjusting the plan. Periodically, a professional biologist should review these records and the plan to see whether the plan is still appropriate.

It may be easier to visualize how to create a map and planning document by looking at an example. Figure 2 shows a diagram of an 80-acre farm. The farm has a mixture of woodlands, abandoned cropland areas (old fields), a spring and a creek, and a small patch of alfalfa. The woodlands have been subdivided into eight separate

small management units based on the information presented earlier in this chapter (Figure 1).

These woodlands have also been placed on a long term rotation with one tract left as old growth forest (no cutting so the forest will mature). Some of the areas are scheduled for a clearcut, whereas others are scheduled for a selection cut based on recommendations from a professional forester.

Part of the objectives for managing the farm was to create habitat for bobwhite quail and cottontail rabbit. Because the old field is predominately fescue, it will be converted to more suitable habitat by creating a series of long, linear food plots, native grass patches, and stripped disked areas. The food plots and stripped disked areas will be rotated on a four-year basis.

Other management activities after 10 years include the creation of a small pond, creation of brush and rock piles for rabbits, placement of nest boxes for bluebirds and wood ducks, and a small food plot planted to milo for white-tailed deer.

This is a very simplified version of a habitat plan for a small farm. Habitat plans will vary according to property size, landowner objectives, and diversity of habitats, and forest types.

## Questions for Chapter 7

1. What seven elements must be present in a good natural resources management plan?

2. Provide a written description on the various types of habitat present on your property.

3. Attach a cover map of your farm.

## Chapter 8

# How Many Wildlife Are on My Property?

Thomas G. Barnes, Jeffery D. Sole, and John Phillips

Most wildlife species are secretive by their very nature and will not willingly hold still long enough to be counted. Thus, the task of determining how many wildlife are on your property is difficult. Yet landowners' most frequently asked question is: "How many deer, quail, turkey, or other wildlife do I have on my land?" This is also probably the least answered question. The best response is that it is not necessary to know the numbers of a wildlife population to properly manage it. What is important is that you understand the basics of how and why population numbers fluctuate. Do you have more animals than a year ago? Do you have fewer animals than a year ago? Do you have the same number of animals as last year? Thus, the population **trend** is the most important factor. A reliable trend tells us if a population is increasing, decreasing, or remaining stable.

To determine trends and fluctuations in populations from year to year, you need to determine an index of the population you are concerned with. By collecting data using the same techniques under the same conditions year after year, you can get a good idea of what is happening to animal numbers. Always keep in mind that it is easier to manage for wildlife that are already present on your property than to try to attract wildlife that are not present. Absence of a native wildlife species generally means that long-term habitat modifications would be necessary to attract that particular animal. By using the following techniques, you can get an idea of what species of wildlife are present on your property and whether those populations are increasing, decreasing, or staying stable. Remember, these techniques are indexes and will not give you a population density estimate or total population size. Keep in mind each technique has inherent biases. For example, track counts for white-tailed deer underestimate the number of fawns, whereas spotlight counts underestimate the number of bucks.

## 1. Night Spotlight Counts

**SPECIES:** White-tailed deer, rabbits, furbearers

**METHOD:** Establish a route that you can drive safely at night which covers all the major habitats on your farm (Figure 1). There are strict laws against spotlighting in the state of Kansas, so be sure to contact your local conservation officer before heading out to spotlight. Explain to the officer what you are doing. **Do not, under any circumstances, have a firearm or any other device capable of**

## killing wildlife present in the vehicle while conducting spotlight censuses.

Begin the route shortly after dark. Drive no faster than 8 mph and record the number of deer, rabbits, or other animals of interest that you see. When you spot a deer during a survey, try to record the age (fawn, yearling, adult), and sex of the animal. Be aware that you will probably see fewer bucks and fawns than are actually present. Conduct the survey in October for deer, raccoons, foxes, and coyotes and during the summer months for rabbits. Be sure to run the route at least three to four times to get an average number. Calculate an index of animals observed by dividing the number of animals seen by the acreage or mileage covered. For example, you observed an average of 24 deer on the established route which covered 4 miles. Your index of the deer population would be 1 deer per 6 miles driven.

## 2. Fecal Pellet Counts

**SPECIES:** White-tailed deer, rabbits

**METHOD:** Establish several permanent transects (imaginary lines) that bisect your farm (Figure 2). Along each of these lines, establish 10 to 40 permanent sample plots (12 by 50 foot for deer and 1-yard square for rabbits). Mark these plots so they can be visited year after year. Within each plot, remove all the rabbit or deer fecal pellets. Recheck the plots after two weeks and count the number of pellet groups. Your index of the deer population would be the number of

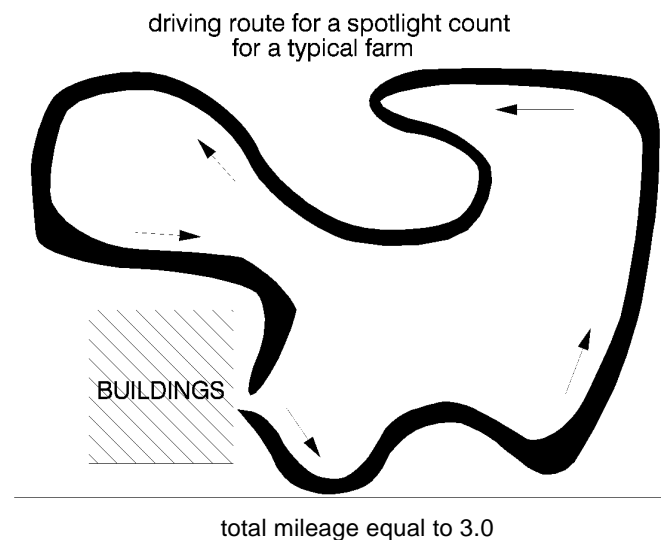

Figure 1

### location of permanent transects and plots used for fecal pellet counts

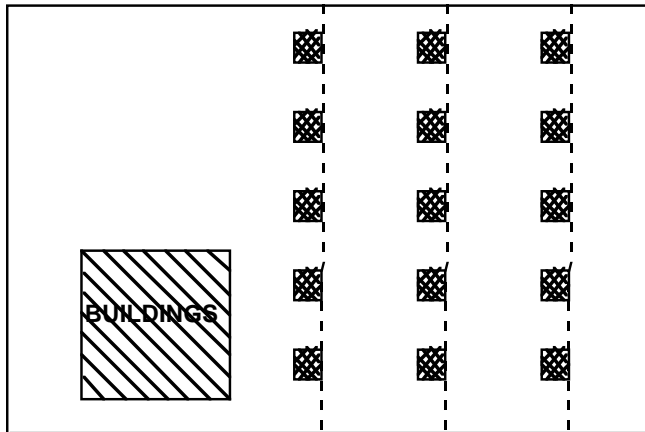

Figure 2

pellet groups per transect. For example, you establish three transects on your land with 10 stations per transect. You observe five pellet groups on Transect 1, three on Transect 2, and 10 on Transect 3. Your index to the population would be an average value of six pellet groups per transect ( $18 \div 3$ ). Deer pellet counts should be conducted in late February to obtain the pre-fawning population.

For rabbits, count all the pellets in the plots. The number of pellets within the plots is multiplied by the total acreage of the plots and divided by a standard defecation rate of 350 pellets per rabbit per day. For example, you establish five plots (each plot was .1 acre) on your farm and find the following number of pellets in each plot: 700 in Plot 1; 1,400 in Plot 2; 350 in Plot 3; 2,100 in Plot 4; and 700 in Plot 5. To calculate the index, multiply  $700 \times .1$ ,  $1,400 \times .1$ , etc. Then add the five plot totals together and divide by 350:

$$70 + 140 + 35 + 210 + 70 = 525$$

$$525 \div 350 = \text{index value } 1.5$$

Rabbit counts should be conducted in the summer.

### 3. Call Counts

**SPECIES:** Bobwhite quail, mourning doves, wild turkey  
**METHOD:** Call counts rely on listening for the calls of birds and recording the number of individuals heard per mile of route traveled or per stop along the route. Establish walking or driving routes with permanent listening posts throughout your property. The listening posts should be far enough apart so the same birds cannot be heard from any two stops. The routes should be designed so they can be completed in less than three to four hours. The number of listening posts or length of driving routes will vary according to the size or total acreage of your property. Important points to remember: keep the posts far enough apart to avoid duplication and sample the same posts/routes at the same time every year. Bobwhite quail and mourning dove census routes may have variable numbers of listening posts.

Surveys should begin 30 minutes before sunrise for wild turkey. Surveys for bobwhite quail and mourning dove should begin at sunrise. If you are conducting a driving route survey, do not slam your vehicle door when leaving the vehicle to begin the count because the noise may cause animals to leave the area. Do not conduct calling count surveys when it is raining, snowing, or windy (wind greater than 7 to 8 mph). The survey is conducted by stopping at each listening post and recording the number of birds calling for a specified period of time (3 minutes for doves and turkeys and 5 minutes for bobwhite quail).

Census routes should be run on two successive days. The routes should be run from one direction the first morning and the opposite direction the next morning. Always record the data so Stop 1 remains Stop 1 regardless of the direction from which the route is run. If the weather is bad on a particular day, the route should be run a third time from the direction of your choice.

Calling census routes should be conducted at the following times:

- for bobwhite quail during late May and early June (peak of quail mating season),
- for wild turkey during April, and
- for mourning doves at various times throughout the breeding season.

Calculate the index by adding the number of birds heard and dividing by the mileage covered. For example, on a driving count for wild turkey with 10 stops, you hear seven turkeys. Your index would be .7 turkeys per mile (7 birds heard divided by 10 miles driven).

### 4. Flush Counts

**SPECIES:** Bobwhite quail, mourning doves, white-tailed deer

**METHOD:** Establish permanent transect lines that cross your property (Figure 3). Establish these transects so they are evenly spaced apart and each individual walking the line will not disturb or affect the wildlife on another line (quarter-mile or more apart). The length of the transect line should cover the entire area to be sampled, but it should not take longer than two hours to complete.

The surveys can be conducted at sunrise or two hours before sunset. They should be conducted several times each year (October or February for white-tailed deer, summer or fall for quail and doves). The surveys should be run during the same general time period each year to allow for comparisons. Individuals conducting the surveys should walk at a normal pace and record the wildlife species seen, the number of each individual species, and the approximate distance from the line each species was observed. A simple index to the population can be calculated using the following formula:

permanent transect lines used for flush counts

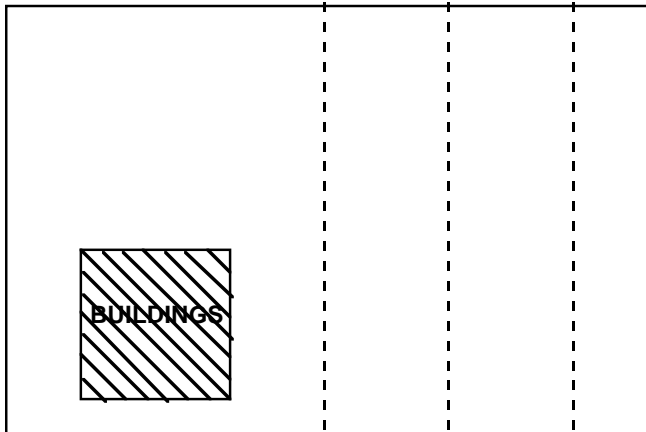

Figure 3

$$P = \frac{A \times F}{2 \times D \times L} \text{ where, } P = \text{the population}$$

$A$  = total area of the study  
 $F$  = number of animals flushed (or seen)  
 $D$  = average flushing distance  
 $L$  = length of the strip walked

For example,  $A$  = 50-acre farm  
 $F$  = 19 quail flushed  
 $D$  = 5-foot flushing distance  
 $L$  = 600 feet walked

The index value would be:

$$0.16 \times 50 \times 19 = 950$$

$$950 \div (2 \times 3,000) = \text{index value } 0.16$$

### 5. Dancing Ground Surveys

SPECIES: Prairie Chicken

METHOD: During the first two weeks of March, observe suitable prairie chicken breeding habitat to determine if the area is occupied by displaying male prairie chicken. Visit each site during the first two hours of daylight when courtship displays are most frequently observed. Increases or decreases in the numbers of calling males are used to index general population trends for the area.

### 6. Track Counts

SPECIES: White-tailed deer, furbearers

METHOD: Disk a long, narrow strip of ground 4 to 9 feet wide along the length of your property boundaries during August (Figure 4). The next morning, count the number of deer that walked through the strip. It is important to follow the tracks of each animal as it entered and left the strip to ensure that each animal is counted only once. Repeat the procedure at least three times to ensure that you did not do a

count on a day when the deer were more or less active than normal. Try to separate the number of fawn tracks from adult tracks (using a size difference) to get a percentage of fawns produced. The index is calculated by counting the number of deer crossing each linear mile. This is equal to the number of deer per square mile.

A variation of this method can be used to census furbearers. Establish several transects crossing your property as you would for a flush count. Establish permanent scent post stations where a small patch of soil is hoed

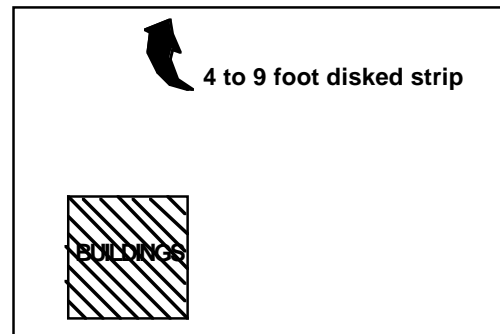

Figure 4

or disked and smoothed over so you can observe furbearer tracks in the dirt. Place a stick in the ground at the center of each station so that 2 inches of the stick is exposed. Smear some furbearer bait (depends on the furbearer you are sampling for) on the stick or pour a teaspoon of fox urine over it. (Furbearer baits and fox urine are available from sporting good stores or trapping/outdoor mail-order catalogs.) The following morning check each scent station and identify the tracks at each scent post. Count the number of scent stations visited to determine an index for the population.

### 7. Other Methods

Biologists use a variety of other methods to determine population levels for various wildlife species. The techniques to sample wildlife populations vary considerably, so an exhaustive treatment is not possible here. Some of these techniques include mark-recapture, aerial reconnaissance for white-tailed deer and waterfowl, mail carrier and roadside wildlife counts, and roadkill counts. These counts often require surveying large amounts of territory, the use of specialized equipment or techniques that are not appropriate or too expensive for private landowner use. For more information about these and numerous other wildlife sampling methods, contact the KDWP or the Extension Wildlife Specialist at Kansas State University.

### 8. Biological Monitoring of the Harvest

The following techniques are not used to gain an index of population levels but are useful in monitoring the health of the particular wildlife population on your property. One

method used for small game is to look at the age composition of animals harvested during the hunting season. The following two examples show how this works for different game bird species.

**Quail.** A general composition of 70 to 80 percent juvenile quail in a harvest would indicate a healthy quail population and a good reproductive year.

**Prairie Chicken.** If approximately 50 percent of the grouse bagged during the hunting season are young birds, this would indicate a healthy prairie chicken population.

### *Summary*

It is not necessary to know the exact number of each species of wildlife to manage that species properly. You should know what species of wildlife are found because it is easier to manage for wildlife species that are already present. It is important to determine if the population of a particular wildlife species is the same, increasing, or decreasing on a yearly basis.

## Questions for Chapter 8

1. Explain call count surveys.
2. What species are used for dancing ground surveys?
3. Why is population trend data more valuable than absolute counts?
4. How do you conduct flush counts?



Questions for Chapter 8 (continued)

5. List two techniques to inventory deer populations.

Name \_\_\_\_\_

## Chapter 9

# An Introduction to Pesticides and their Effects

by Elizabeth Stinson and Peter Bromley

Although scientific inquiries into the effects of pesticides on wildlife began before the 1960s, it was the 1962 publication of Rachel Carson's *Silent Spring* that riveted the attention of wildlife biologists, farmers, and the public on the effects that pesticides were having on wildlife and the environment. When *Silent Spring* was written, the predominant pesticides used were a class of synthetic chemicals called organochlorine pesticides.

The organochlorine pesticide that most people think of in relation to detrimental effects on wildlife is dichlorodiphenyltrichloroethane (DDT). However, other organochlorine pesticides, including toxaphene, dieldrin, endrin, and chlordane, also were found to be harmful.

Organochlorine pesticides are persistent in the environment and accumulate in fats (lipids). Consequently, these chemicals bioaccumulate or build up in the food chain. For example, when DDT is present in small amounts in water, it is absorbed and stored by algae and microscopic plants. Small aquatic animals feeding upon these plants are in turn eaten by fish and other creatures that then also become contaminated. At each step the concentrations of DDT and its metabolites (breakdown products), DDE and DDD, increase. When fish-eating birds, such as ospreys and brown pelicans, repeatedly consume contaminated fish, they amass even greater amounts of DDT and DDE in their body fat. Concentrations of DDT have been known to increase as much as 10 million times from water to seabirds as DDT made its way through the food chain. Problems arose when concentrations of DDT or one of its metabolites, DDE, became high enough in animals, especially birds, to cause toxic effects. These effects included death due to pesticide poisoning and reproductive problems, such as eggshell thinning. Nests failed because eggs were easily broken by the incubating bird. Populations of many bird species became dangerously low because of DDT. For example, bald eagles and brown pelicans almost were driven to extinction in many parts of this country due to DDT and other organochlorine pesticides. Peregrine falcons almost disappeared, with few populations surviving anywhere in the continental United States.

DDT and several other organochlorine pesticides were banned in this country in the 1970s. Bird populations affected most by DDT, including peregrine falcons, bald eagles, and brown pelicans, have begun to make a slow comeback.

Although DDT was banned in this country almost 20 years ago, because of its persistence, wildlife continue to be contaminated with DDT and its metabolite DDE. Bobwhite quail in Virginia still contain DDT, DDE, and other organochlorine pesticides in their body fat. Many wildlife species still die each year from organochlorine poisoning. In the southwestern United States, bats, which are very sensitive to the effects of DDT, continue to be poisoned by it. New York State biologists have documented deaths of hawks and owls due to the buildup of organochlorine contaminants in the brains of these birds. Many organochlorine pesticides banned in the United States still are used in Central and South America. Migratory birds, such as warblers and some hawks, accumulate harmful concentrations of pesticides while overwintering in these southern regions. Although DDT and other organochlorines still cause problems, the ban on most of these chemicals in the United States has been extremely important in the continued survival of many wildlife species. With mounting evidence of the negative impacts of organochlorine pesticides in the environment and the removal of many of these harmful pesticides from agricultural use, the pressure to find nonpersistent, effective insecticides increased. Today, organophosphates and carbamates are the two major groups of insecticides used. Organophosphates include the insecticides diazinon and ethyl parathion. Carbamates include the insecticides carbaryl and carbofuran. Organophosphates and carbamates are much less persistent in the environment than organochlorines. However, organophosphates and carbamates are also much more acutely toxic; that is, even very small doses of some of these insecticides can cause immediate and severe poisoning. Both organophosphates and carbamates exert their effect on animals by inhibiting the enzyme acetylcholinesterase. This enzyme destroys acetylcholine, the chemical messenger that links nerves so that nerve impulses can be sent. If acetylcholinesterase is inhibited by an organophosphate or carbamate, it is unavailable to break down the nerve messenger acetylcholine, and nerves continue to fire uncontrollably. Any animal, including man, with acetylcholine in the nervous system can be poisoned in this manner.

The toxicity of organophosphate insecticides can be quite variable. For example, tetrachlorvinphos (Gardona®, Rabon®) is only slightly toxic to mammals and birds, while phorate (Thimet®) is extremely toxic to mammals and birds and has caused wildlife die-offs. The carbamates also span a

range of toxicities, from one of the less acutely toxic carbamates, carbaryl (Sevin®), used by many household gardeners, to aldicarb (Temik®) and carbofuran (Furadan®), two of the most toxic carbamates.

Many organophosphate and carbamate pesticides are extremely hazardous to wildlife. Numerous dramatic wildlife die-offs involving both organophosphate and carbamate insecticides have been documented. Some of the largest kills have involved thousands of animals.

The fourth and fifth major categories of insecticides are the botanicals and the synthetic pyrethroids. The botanicals are derived from plants and include pyrethrum, rotenone, saba-dilla, ryania, and nicotine. The synthetic pyrethroids resemble the botanical pyrethrum but are more stable and usually more effective at lower application rates. The synthetic pyrethroids include allethrin (Bioallethrin®), resmethrin (Scourge®), fenvalerate (Pydrin®), permethrin (Ambush®, Pounce®), and cypermethrin (Ammo®). Botanical and synthetic pyrethroid insecticides generally are less directly hazardous to wildlife than organophosphate or carbamate insecticides. However, many of the botanicals and synthetic pyrethroids are extremely toxic to bees, fish, and aquatic invertebrates, and they should not be used near waterways or when bees are active around blooming plants.

Microbials and insect growth regulators are two other important types of insecticides. Microbial controls include *Bacillus thuringiensis* (BT), a bacterium that causes disease in insects but does not harm other animals or plants. Insect growth regulators alter growth and development in insects. Diflubenzuron (Dimilin®) and methoprene (Altosid®) are insect growth regulators. Both microbials and insect growth regulators are considered safest to use where wildlife are a high priority. However, as with any other pesticide, microbials and insect growth regulators must be used thoughtfully to avoid harming nontarget organisms. For example, diflubenzuron acts by blocking the formation of chitin, an important component of an insect's hard exoskeleton (outer shell). It acts on beneficial insects and aquatic invertebrates with exoskeletons as well as pest insects, and thus must be used with utmost care so as not to expose beneficial organisms.

## Herbicides

Most commonly used herbicides are much less toxic to wildlife than many insecticides. Some exceptions are paraquat (Gramoxone®), metribuzin (Lexone®), Sencor®), bromoxynil (Buctril®, Brominal®), cyanazine (Bladex®), and sodium arsenite (Atlas A®, Kill-All®), which are all highly toxic to birds and mammals.

Probably the most significant impact of herbicides on wildlife is habitat alteration. In some cases, herbicides can be used as a management tool to create wildlife habitat. For

example, older plant communities can be set back to earlier successional stages with herbicides. Earlier successional stages benefit species like bobwhites and cottontails. Herbicides also can be used in combination with disking to destroy fescue, a hardy non-native grass with little wildlife value, so that native grasses or other plants beneficial to wildlife can be reestablished.

On the farm, herbicides often are used to control weeds in cropland and to maintain weed-free fencerows. These uses harm wildlife by destroying vegetative cover, seed producing plants, and insect habitat. Brushy fencerows provide food and cover for many wildlife species. Although these results may be desirable from a strictly agricultural viewpoint, they are not compatible with wildlife interests. These topics are discussed in greater detail in a later section of this manual.

Conservation tillage techniques often rely extensively on herbicides. These methods have been viewed as both a boon and a bane to wildlife. Some studies have shown that many wildlife species make greater use of conservation tilled croplands than conventionally tilled croplands, primarily because of more abundant food and cover on conservation tillage fields. However, conservation tillage cropland often requires higher inputs of both herbicides and insecticides, and the long-term effects of this increased exposure to pesticides on wildlife remain uncertain.

Generally, there has been less controversy concerning the effects of herbicides on wildlife than that surrounding the effects of insecticides. This is due in part to the absence of dramatic wildlife kills associated with herbicide use. However, current issues, such as wildlife habitat loss, herbicide contamination of groundwater, and herbicide runoff into the Chesapeake Bay, have generated a growing interest in the effects of herbicides on the environment.

## Fungicides

There are few reports of wildlife kills attributed to fungicides currently in use. However, relatively little is known about the toxicity of these chemicals to wildlife species. In the past, some fungicides have been banned due in part to their adverse effects on wildlife. Fungicides containing mercury were discontinued for home and agricultural use in the United States in 1976. These fungicides often were used as seed dressings and caused the deaths of birds eating the treated seed. Mercurial fungicides also accumulated in the environment. Accumulation of mercury in the food chain caused the deaths of predatory birds and mammals.

Hexachlorobenzene (HCB) is another discontinued seed treatment fungicide known to have had adverse effects on wildlife. Like the organochlorine insecticides, HCB accumulated in animal fat and in the environment. This persistent fungicide posed a hazard to seed-eating birds, because low concentrations reduced egg hatchability and higher

concentrations caused death. Although this fungicide is no longer in use, a recent study found that hexachlorobenzene was the second most commonly found contaminant in bobwhite quail in Virginia.

Currently used fungicides are generally much less acutely toxic to wildlife than most insecticides. However, some fungicides, including PCNB (quintozene), chlorothalonil (Bravo®), Exotherm®, dichlone (Phygon®, Quintar®), folpet (Phaltan®), captan (Orthocide®), anilazine (Diyrenene®), ferbam (Carbamate®), benomyl (Benlate®), and thiram (Arasan®), are hazardous to fish and other aquatic species. Captafol was recently cancelled for use for several reasons, including high toxicity to fish. Cycloheximide (Actidione®) and fentin chloride (Tinmate®) are extremely toxic to some mammals. Binapacryl (Morocide®) and triphenyltin hydroxide (Du Ter®) are also very toxic to some mammals. Some commonly used fungicides are poisonous to beneficial soil invertebrates. For example, benomyl (Benlate®), thiophanate methyl (Topsin M®), and thiabendazole (Arbotect®, Mertect®) are toxic to earthworms and reduce their populations. When repeatedly used, copper containing fungicides (including Bordeaux Mixture) can accumulate in soil over the years and kill earthworms. This is significant in orchards, for loss of earthworms in this environment can lead to accumulation of leaf litter that harbors fungal spores harmful to fruit trees.

### *The Toxic Equation*

How do pesticides harm wildlife? There are several factors that must add up to cause the death or injury of wildlife. A pesticide's capacity to harm animals is a function of its characteristics, its toxicity, the time and duration of exposure, and the dose. A pesticide's characteristics, for example, include a pesticide's ability to build up in the food chain or in the fat of animals. The toxicity of the pesticide is how poisonous it is. The time at which an animal is exposed can be significant; for example, birds may be more susceptible to a pesticide's effects during nesting in the spring or during times of low food availability. Because a brief exposure to some chemicals may have very little effect on an animal, whereas a longer exposure period may cause greater harm, the duration of exposure can be important. The dose that an animal is subjected to will also make a difference; for example, a very small dose of a more toxic chemical may be less damaging than a large dose of a less toxic chemical.

### *How Are Wildlife Exposed to Pesticides?*

#### **Primary Exposure**

Wildlife can be exposed to pesticides in the same ways as humans. Exposure occurs through swallowing the chemical, either by itself or on food items; through coming

into contact with the chemical and absorbing it through the skin; and by inhaling pesticide vapors when the chemical is applied. Methods to reduce exposure to pesticides have been developed for humans. These include wearing protective clothing to avoid skin contact, avoiding entry into treated fields for a prescribed period of time, and regulating minimum waiting periods between spray and harvest, so that pesticide residues on food crops have time to break down before they are eaten by humans or livestock.

Although these precautions are usually effective in protecting humans, they do nothing to reduce exposure of wildlife. Wildlife do not wear protective clothing and cannot read signs that warn against entering fields. Ground-nesting birds remaining on their nests during a spraying operation may get pesticide droplets on their feathers and skin and inhale pesticide vapors. Those birds that flush and reenter after spraying or those that enter a field after treatment will come into contact with treated vegetation. They also may drink, bathe, or swim in pools of water that have accumulated pesticide runoff. Exposed pesticide granules can be consumed by birds that mistake them for grit or seed. One granule of Furadan 15G® (carbofuran) is enough to kill a sparrow-sized bird. The eggs of nesting birds also can be exposed to pesticides, by contact with spray or by contacting pesticide contaminated feathers and skin of the adult bird sitting on the nest.

#### **Secondary Exposure**

Wildlife can be harmed not only by direct contact with a pesticide but also indirectly, by consuming another animal that has had significant exposure to a pesticide. Poisonings that occur in this manner are termed "secondary poisonings." Birds can be attracted to insects dying on the soil surface after insecticide treatment. During brood rearing, adult birds may feed contaminated insects to nestlings. In some cases, insects or other prey poisoned by insecticides contain enough of the chemical to kill the animal that consumes them. Raptors are susceptible to secondary poisoning when they prey upon birds and rodents made vulnerable by primary insecticide poisoning.

Initially, it was believed that organophosphate and carbamate insecticides would present less secondary poisoning hazard to wildlife than the persistent organochlorine insecticides that they replaced. However, because of the extreme toxicity of many of these compounds, wildlife remain at risk.

#### **Sublethal Effects**

Not all pesticide poisonings result in the immediate death of an animal. Smaller "sublethal" doses of some pesticides can lead to changes in behavior, weight loss, impaired ability to reproduce, inability to avoid predators, and lowered tolerance to extreme temperatures.

Bobwhites, cottontail rabbits, and other wildlife closely linked to agricultural environments are likely to receive repeated doses of pesticides on their food if they reside in areas where pesticide applications occur. Although scientists do not always know what effects this repeated exposure may have on wildlife, laboratory studies indicate what can occur. For example, repeated exposure to diazinon in the diet can cause reduced egg production in birds and decreased body weight in both birds and mammals. Low concentrations of paraquat on food cause weight loss in bobwhites. Small repeated doses of the organophosphate parathion cause hormonal changes in bobwhites and reduce their ability to survive very cold temperatures. Carbofuran in bobwhites' food causes them to eat less, lose weight, and be less mobile.

Even a one-time exposure to sublethal amounts of some insecticides can have a significant effect on wildlife without causing death by direct poisoning. For example, scientists found that ducks nesting next to an agricultural field treated with a one-time application of methyl parathion were more likely to be killed on the nest by predators or to abandon their broods than were ducks that nested near an unsprayed field. Although wildlife losses that are indirectly caused by the sublethal effects of pesticides are difficult to verify, they probably occur.

### ***Habitat Alteration and Lost Food Resources***

Loss of food resources and habitat alteration are subtle but important effects of agricultural pesticides on wildlife. Wildlife food resources can be reduced by both insecticide and herbicide application and can have significant effects on individual animals and local populations.

Many wildlife species' reproductive periods correspond with peaks in abundance of insects. Loss of this high-protein food can be damaging to breeding adults and especially to young, growing animals. For example, bobwhite chicks are dependent upon a diet of insects during the first few weeks of life. This high-protein food is essential for adequate growth and normal feather development.

Insect-eating animals lose a portion of their food supply when insecticides are applied within their home range. Scientists have found that pheasant chicks feeding in insecticide treated fields had less than one-tenth of the insect material found in the crops of chicks foraging in untreated fields. Studies in England show that the survival of partridge chicks is reduced where insecticides are sprayed on cereal crops. A suddenly inadequate supply of insect foods forces wildlife to range further in search of food. Consequently, wildlife in this situation must use more of their energy reserves and risk greater exposure to predation.

Herbicides can reduce availability of both plants and insects as food supplies. Spraying herbicides on weedy areas destroys insect habitat, leading to less abundant and diverse insect populations available as wildlife foods. Loss of seed

producing "weed" species from repeated herbicide use results in an additional decline in food resources. The importance of herbicide use as a contributing factor in loss of wildlife cannot be overlooked. In fact, in Britain, herbicide use on cereal crops is cited as a primary cause of the decline of the partridge, due to lowered food resources and the resulting increased movement of partridge broods.

Before the days of widespread herbicide use, weedy fencerows, brushy drainages, and rough areas were a common sight on farms. These rough areas provided wildlife with food as well as travel corridors, nesting cover, and protective shelter from the elements and predation. Today, using herbicides to "clean up" these areas contributes to loss of wildlife by removing these important habitat components. Casual use of herbicides for farm "beautification" will directly reduce wildlife numbers on the farm.

The landowner or farmer who treats a weedy fenceline or hedgerow with herbicides does much more than just "clean up" the farm. Picture what else he does, completely unintentionally: kills the trumpet vine that hummingbirds used and the honeysuckle that deer and quail fed on; kills the sunflower and thistle that would have provided winter food for goldfinches; kills the clover that deer, turkeys, rabbits, and quail were using; removes the cover that protected field sparrows, cardinals, white-footed mice, rabbits, and quail from predation and winter winds; kills the pokeweed that mourning doves loved to eat; destroys nest sites for kingbirds, vireos, and cottontail rabbits.

### ***How Real is the Hazard?***

Although documented kills do give some indication of the existing hazard of pesticide exposure to wildlife, they do not accurately reflect the extent of the hazard. Undoubtedly, many pesticide-related wildlife kills go unreported, and the number of animals involved in reported kills is probably underestimated. The small size and camouflage coloring of many small birds and mammals makes them difficult for human searchers to see. Also, scavengers quickly remove carcasses from a kill site. Dying and sickened animals may hide in dense cover or leave the area completely. Some bird species will rapidly move into an area when the original residents are killed, masking the effects of a local kill. In addition, the remoteness of many agricultural areas often precludes there being anyone in the vicinity to notice a kill.

When dead wildlife are found after a pesticide application, the incident may go unreported because it is not considered important or because of fear of liability. Sometimes no association is made between a kill and a past pesticide application because of the amount of time that has lapsed. For example, carbofuran can cause wildlife mortality as many as 60 days after it is applied to crops.

Evidence that a particular pesticide has repeatedly caused wildlife deaths serves as a warning signal that a serious hazard exists. Such pesticides should not be used.

## ***Ways To Reduce Effects***

There are a number of ways to reduce the effects of pesticides on wildlife. The following sections contain information about less toxic pesticides, application methods that help reduce wildlife exposure, protection of threatened and endangered species, and agricultural systems that decrease pesticide risk to wildlife.

### **Using Less Toxic Pesticides**

Perhaps one of the most apparent ways to reduce the effects of pesticides on wildlife is to use those chemicals that are least poisonous to animals. When selecting a pesticide, use the least toxic alternative that will do the job.

### **Application Methods to Reduce Wildlife Exposure to Pesticides**

Many of the application techniques and guidelines that reduce wildlife exposure to pesticides are the same as those used to reduce human exposure, environmental damage, crop damage, and waste of expensive chemicals through over-application. The first rule of responsible pesticide use is to read the pesticide label and follow the directions precisely. Label instructions sometimes can be confusing. If you are not 100 percent sure that you understand them, contact your extension agent, your supplier, or the pesticide company representative for clarification.

When reading the label, watch for warning statements about environmental hazards. If a pesticide is especially dangerous to wildlife, it will be stated on the label. Statements to look for include:

“This product is toxic to birds and other wildlife.”

“This product is toxic to fish.”

“This product is highly toxic to bees.”

If you see these statements, look for label information on ways to avoid exposing wildlife.

Remember that even following the label precisely does not guarantee that wildlife will not come into contact with a pesticide. For example, birds may enter a field after pesticide treatment. For this reason, it is extremely important when selecting a pesticide to select the least toxic and least persistent alternative that will do the job.

Ensure that your application equipment is in good working condition. This not only helps protect your environment but also makes good economic sense. Check for leaks, replace worn parts, and calibrate your equipment carefully. When mixing pesticides be certain that you are mixing the correct concentration. Read the label or contact your extension agent if you are unsure what rate to use. Don't puddle sprays during application or when cleaning equipment, because birds may be attracted to these puddles to drink or bathe. Never wash spray equipment in lakes, ponds, or rivers. If you draw water from these areas, use an anti-siphon device to prevent backflow. Store and dispose

unused chemicals and their containers carefully so that wildlife do not have access to them. Your extension agent can offer you further information on calibrating equipment, measuring and mixing pesticides, and storing and disposing chemical containers.

During application, avoid overlapping spray swaths. Again, this makes sense from both a wildlife and economic point of view. To avoid pesticide drift into nontarget areas, use the pesticide, formulation, and application equipment that keep the application on target. Treat only the areas needed. Avoid spraying on windy days; early morning and late afternoon are usually the least windy.

Don't apply pesticides if there is a potential for heavy rainfall soon after application. Heavy rains can cause pesticide runoff into bodies of water and deep leaching of chemicals into soil and groundwater. In the event of an unanticipated heavy rain after a pesticide application, do not reapply the pesticide immediately. Instead, monitor the crop for pest damage to see if the first treatment was effective. If you are applying pesticides near water, leave at least a 50-foot buffer strip between the pesticide treatment area and the body of water to avoid contaminating water and aquatic organisms. Don't spray trees that overhang aquatic areas.

Be extremely cautious when applying granular insecticides. Granular pesticides concentrate the active pesticide ingredient in a small granule, usually made of clay, sand, or corn cob. Many of the insecticides that are most toxic to birds have been formulated this way. Unfortunately, these granules are attractive to birds, which probably mistake them for food or grit. This creates an extremely hazardous situation, because eating just a few granules of some granular insecticides (e.g., Furadan 15G®, Dasanit 15G®), Temik 15G®, Tattoo 10G®, Diazinon 14G®, Dyfonate 20G®), and Nema-cur 15G®) is enough to kill a sparrow-sized bird. Careful soil incorporation of granular insecticides is required to reduce wildlife hazard. Be on the lookout for granule spills at the ends of rows and on rough terrain. To avoid wildlife exposure, clean up these spills or completely cover them with soil. Using less toxic granular pesticides can help increase the margin of safety for birds that forage in crop fields.

Where wildlife are a priority, avoid using insecticides during bird nesting and brood rearing, when young birds require a plentiful source of high-protein insects. Also, avoid using highly toxic insecticides during migration when birds may be stressed and more susceptible to the effects of pesticides. You can protect valuable wildlife areas by keeping pesticides well away from woodlots, wetlands, ditches, hedges, fencelines, and rockpiles.

Don't overspray field margins and edges, and leave headlands untreated. In England, research has shown that wild partridge chick mortality was reduced by not spraying herbicides on the outer 6 meters (about 20 feet) of crop field margins. This practice left broad-leaved weeds in the

borders of crop fields to provide habitat for predatory insects and insect food for partridge chicks. If necessary, herbicide treatment can be resumed on the unsprayed areas in the fall, when young birds have grown less dependent on high-protein insect foods. Avoiding herbicide and insecticide treatments of field margins may be beneficial to bobwhites.

### ***A Word About Orchards***

Pine voles and meadow voles are two of the most common pests of orchards. Vole control in orchards often includes the use of rodenticides in fall and winter. Using rodenticides in orchards presents a hazard to nontarget wildlife from both primary and secondary poisoning. Songbirds, cottontail rabbits, and quail are known to have been killed by eating rodent baits in orchards. Rodents consuming anticoagulant baits (rodent baits treated with chemicals that hinder the clotting of blood) remain active while anticoagulants are taking effect. This presents a secondary hazard to predators like screech owls that prey primarily on small mammals during the winter when rodenticides are used. Studies have shown that screech owls preying on poisoned rodents risk internal bleeding and death even two months after treated bait had been set out.

To avoid poisoning nontarget wildlife, traps, rather than poisons, should be used if vole populations are high enough to cause orchard damage. Victor® house mouse traps baited with apples and placed at a density of about 100 traps per acre can be effective in controlling voles. Traps should be inspected each day and reset if necessary. Using traps may be less feasible in very large fruit orchards.

Shrikes, hawks, owls, foxes, raccoons, weasels, and skunks are just a few of the wildlife species that eat small rodents, including voles. Having these predators nearby may help keep rodent populations down. Hedgerows, rough areas, and rock piles on orchard borders can serve as cover to help attract these species. Black rat snakes and several other snake species are extremely efficient rodent predators. A healthy population of these reptiles in an orchard can be an effective way to help control vole populations. Snakes are most active during warmer months, when vole populations are building up. You can manage your orchard for snakes in summer and early fall by allowing grasses and weeds to grow up. Rotary mowers decimate snake populations in orchards. After the killing frost in late fall, you can mow grass closely throughout the orchard to destroy rodents' protective cover, better exposing them to natural predators like hawks and owls.

If rodenticides are going to be used in an orchard, then it is best to use those that are least hazardous to wildlife and to place them in vole runways rather than broadcasting them. Chlorphacinone (Rozol®) is effective against rodents, yet appears to be less toxic to wildlife than diphacinone (Ramik-Brown®). Kills of wildlife species, including foxes,

mountain lions, and raccoons, have been attributed to diphacinone.

Paraffin (wax) coated rodenticides like Parapel® (chlorphacinone) can present a hazard to birds that is unrelated to the bait's anticoagulant properties. For example, quail eating paraffin coated baits can accumulate a paraffin mass that becomes impacted in their crops and gizzards, causing starvation. Avoid having paraffin coated baits available to birds.

Zinc phosphide (ZP Rodent Bait AG®) is toxic to wildlife and should not be broadcast on open ground where it can be easily found by birds and other nontarget animals. However, when placed under cover or in vole holes or runs, it is not considered to be as hazardous as some other rodenticides. Secondary poisoning appears to be less of a risk with this chemical because poisoned rodents are killed quickly, making them less available to predators. Zinc phosphide also is broken down fairly quickly in rodent carcasses, posing less risk to scavengers.

### ***Endangered Species and Pesticides***

Congress passed the Endangered Species Act (ESA) in 1973 to protect animals and plants that are threatened or in danger of becoming extinct and to protect their habitat. The ESA requires that any action authorized by a Federal agency, such as the registration of pesticides by the United States Environmental Protection Agency (EPA), does not harm threatened or endangered species or their habitat. Because some pesticides may harm such species, the EPA is developing an Endangered Species Protection Program to protect species and their habitats from the effects of pesticides.

EPA will use a species-based approach for the program. With this approach, EPA will gather information on the habitats and locations of endangered and threatened species and determine the pesticides to which the species may be exposed. If a pesticide is determined to jeopardize the species, the EPA and/or the United States Fish and Wildlife Service will develop habitat maps that will become part of pesticide labelling and county bulletin instructions.

Pesticide products that jeopardize endangered or threatened species will be required to have a statement on the pesticide label. This statement will instruct users to determine if there are any limitations on the pesticide's use in the county where it is to be applied. County bulletins will contain information on use limitations. For those counties where use limitations apply, the bulletins will contain county maps showing the geographic area associated with each species of concern. The bulletins will identify the pesticides that jeopardize these species and describe the use limitations that apply.

The bulletins will be widely distributed and available through the County Extension Service, pesticide dealers and

distributors, Soil Conservation Service offices, United States Fish and Wildlife Service offices, EPA offices, and the offices of state regulatory agencies. The program in Kansas is administered by the Kansas Department of Agriculture.

### *Integrated Pest Management*

Integrated pest management (IPM) is a pest management strategy that has the potential to reduce pesticide inputs to the environment. The IPM system was developed largely in response to increasing occurrence of pesticide resistant insects, target pest resurgence, and secondary pest outbreaks caused by overuse of pesticides. Other factors such as groundwater contamination, increasing cost of agricultural chemicals, consumer concerns about pesticide residues on foods, and concern for the environment also helped stimulate development of this system.

IPM is defined most simply as an agricultural management system that uses all available tactics to manage pests. These tactics can include:

1. Cultural controls, such as crop rotation and timing planting dates to avoid pests.
2. Host resistance, that is, using plants and livestock that are resistant to pest attack.
3. Mechanical and physical controls, including pest barriers and insect traps.
4. Biological controls, using insect predators that feed on target pests, parasites that attack pests, and pathogens that cause disease in target weeds or insect pests.
5. Chemical control using pesticides.

IPM is based on extensive scientific research on crop pests, their natural enemies, and cropping systems. Growers using IPM are involved in an active pest scouting program. The key to IPM lies in identifying and assessing population numbers of both pests and their natural enemies to predict future population trends and determine if pest control action is necessary. Pesticides are not applied until pest populations reach an economic threshold where the cost of not treating a crop (or portion of a crop) exceeds the cost of treatment. By using pesticides only when pests have reached some threshold rather than spraying on a calendar basis, the IPM grower gives naturally occurring insect predators, parasites, and pathogens a chance to keep pest populations at lower levels. The importance of the pest control exerted by naturally occurring organisms beneficial to the farmer is usually unseen, but its value is significant.

Ideally, IPM makes active use of pest predators, parasites, and pathogens to reduce the need for pesticides. The benefits of IPM to wildlife depend partly on the agricultural system in which IPM techniques are used and

the abundance of agricultural pests in a given year. IPM is a flexible system and can be thought of as existing along a continuum, with growers using as many or as few IPM tactics as they like. At one end of the continuum are those growers who use only the pest scouting component of IPM to determine when it is most economical to apply pesticides. During years with low pest pressure, these growers may use pesticides less frequently or at lower rates than non-IPM growers. However, during years when pest pressure is high, IPM growers at this end of the continuum may use more pesticides than non-IPM growers.

At the other end of the continuum are those growers who integrate many different pest management strategies into their farming systems. As more alternative control measures like crop rotation and use of beneficial insects are incorporated into a farming system, the frequency with which pesticides are applied tends to decrease and crop diversity often increases. Both of these conditions are likely to benefit wildlife.

The concepts of IPM, reduced pesticide use, and diversity are closely interrelated. Just as wildlife managers recognize habitat diversity as one of the key principles in maintaining healthy wildlife populations, agricultural land managers are now using biological diversity to promote crop health. Many "new" practices that increase cropping diversity were commonly used in the past, before synthetic fertilizers and pesticides became widely available.

Increasing interest in sustainable agriculture and organic farming is evidence of the movement toward more diverse cropping systems. Some of the benefits of diverse systems include reduced soil erosion, improved water quality, enhanced nutrient cycling, and reduced pesticide inputs. These systems are also economically competitive with conventional farming systems.

Diverse farming systems can be good for wildlife, too. Comparisons of wildlife populations on organic and conventional farms in Nebraska and Iowa showed that numbers of breeding bird territories and bird populations were about eight times greater on organic farms. These differences were attributed to greater habitat diversity provided by crop rotations on the organic farms, and possibly to reduced inputs of highly toxic and persistent pesticides.

Integrated pest management focuses on the crop system and takes into account that pests are simply a subsystem of the crop system. Wildlife too can be considered a part of the crop system. IPM growers rely on a cost-benefit approach to pesticide use. For some growers, it may be appropriate to include potential impacts of pesticide use on farm wildlife in the analysis.





## Questions for Chapter 9

1. What author in 1962 focused attention on the impacts of pesticides on work and the environments?
2. Why is DDT still found in some tissue samples?
3. What is the most significant impact of herbicides on wildlife?
4. How do pesticides harm wildlife?

### Questions for Chapter 9 (continued)

5. List five application methods to reduce wildlife exposure to pesticides?

6. Why does IPM have the potential to reduce pesticide inputs to the environment?

Name \_\_\_\_\_

### Questions for Chapter 7 (continued)

4. Attach a copy of your management plan.

Name \_\_\_\_\_

## Chapter 10

# Wetland Ecology and Value

Art Boebinger

More than 145 million ducks were making the trip from Alaska, Canada, and the northern prairie states to southern wintering grounds when our fathers and grandfathers were returning from World War II. Today, that number has dropped by half to 64 million. The main factor in the decline of our waterfowl resource is loss of habitat. Since World War II we have been losing wetland habitat nationwide at a rate of 250,000 acres a year. If we assume ducks are an “indicator species” that reflect the quality and quantity of wetland habitat, it is obvious that other wildlife species dependent on wetlands may be in trouble, too. A conservative estimate is that 95 plant, five mammal, 22 bird, four reptile, three amphibian, and 22 fish species listed as endangered or threatened depend on wetland habitats for survival.

In spite of the efforts of the federal government, individual states, and private organizations, such as Ducks Unlimited, wetlands (and consequently ducks and other wetland wildlife species) have declined at an alarming rate (Figure 1). A recent report to Congress estimated that 53

percent or more of the original wetlands in this country have been destroyed in the past 200 years. California has lost more than 91 percent of its original wetlands, whereas Florida, with 9.3 million acres, has lost the most acreage. A number of states have lost at least 70 percent or more of their original wetland acreage (Figure 2).

Kansas has suffered a similar loss. It is estimated that before the state was settled, 841,000 acres of land were classified as wetland. Today, slightly more than 400,000 acres (48 percent of the original number) are so classified. Much of this remaining acreage has been degraded by urban sprawl, mining, or farming activities. The vast majority of these were shallow, often temporary wetlands called palustrine wetlands, and were drained between the mid-1950s and mid-1970s. Is there any wonder that populations of ducks and other wetland-dependent species have declined drastically?

## What is a Wetland?

**Wetlands** are areas where water is the primary factor

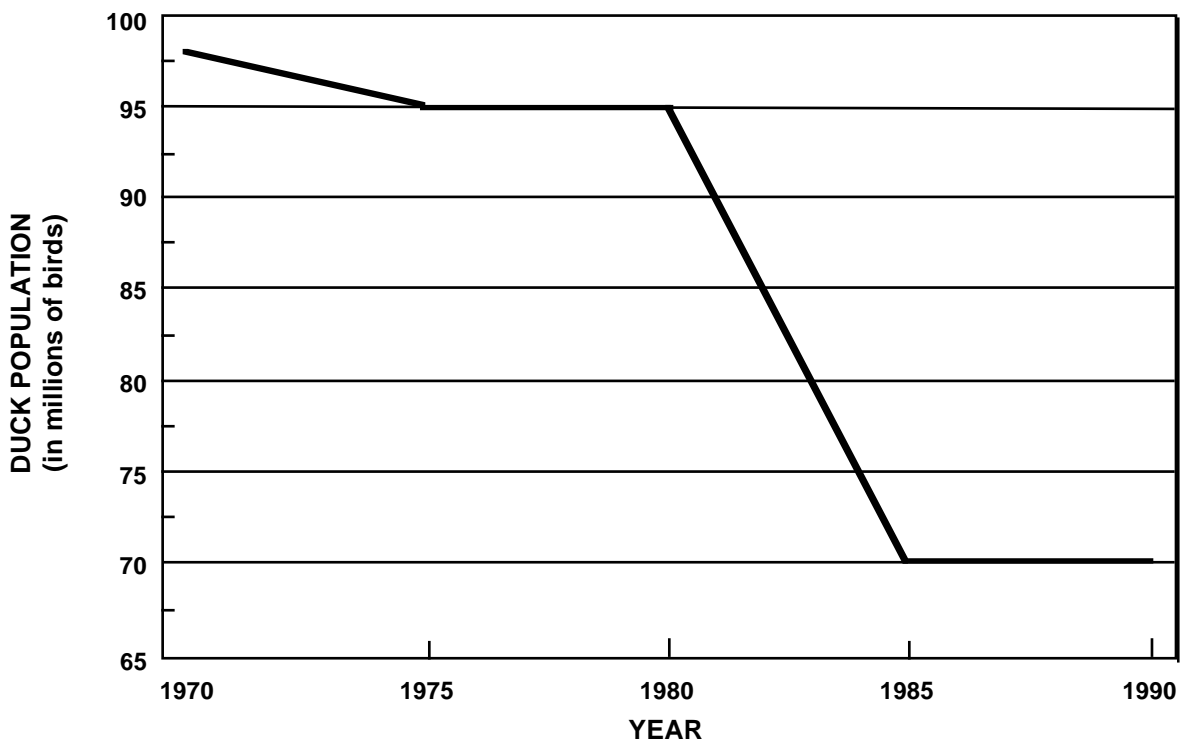

Figure 1. Waterfowl populations have dropped dramatically in the past few years. These losses have been attributed to a loss of breeding, migration, and wintering habitat.

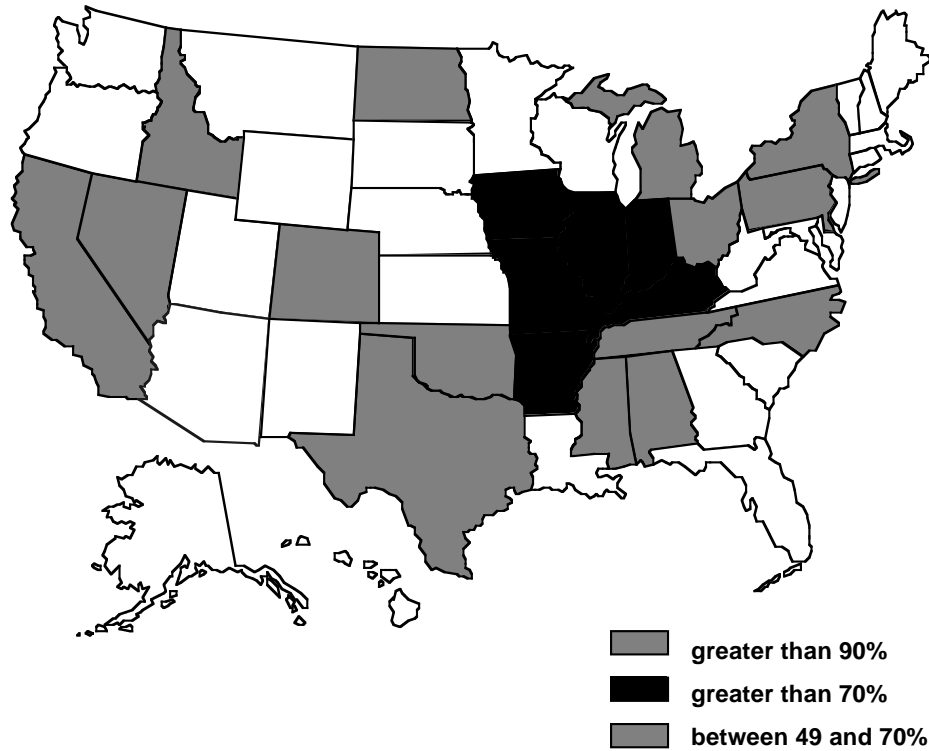

Figure 2. The illustration shows the extent of wetland losses in the United States. California and Ohio have lost more than 90 percent of their original wetlands, while Florida has lost the most acreage. Kansas has lost more than 40 percent of its original wetlands.

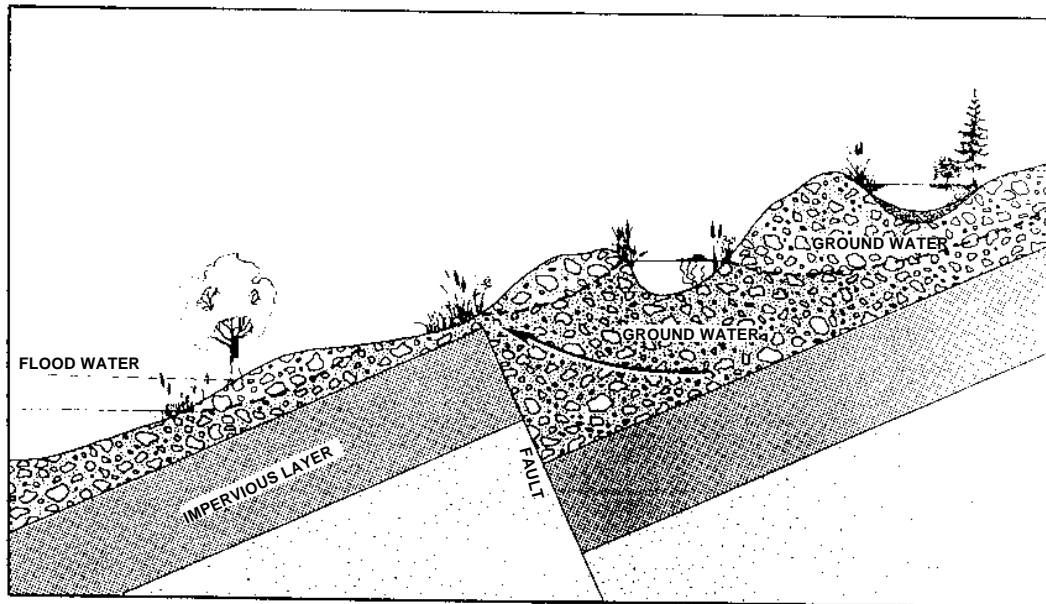

Figure 3. Four basic ways in which water influences wetland formation. A wetland is formed when surface water collects in poorly drained depressions (depicted by the top far right wetland). Because these basins have no outlet, water leaves only through seepage and evaporation. These wetlands are often temporary and overlooked.

The second wetland is found in areas where the ground surface drops below the water table. Marshes may be found here.

In some places underground rock formations force groundwater to the surface. This results in springs and seeps frequently associated with wetlands.

The final wetland on the far left of the diagram is formed by lake and stream floodwater. These habitats depend on seasonal fluctuations of standing or flowing water.

controlling the environment and the associated plant and animal life. Most people recognize wetlands as a transition between aquatic environments and uplands where:

- the water table is at or near the surface of the land, or
- the land is covered by water to a depth of no more than 6 feet.

Thus, wetlands are areas covered by water or having waterlogged soils for periods during the growing season. Wetlands, like swamps and marshes, are obvious to most people. Some wetlands, like bottomland forests, playas, or wet meadows, are not so easily recognized because they are dry during part of the year or simply do not look very wet.

While the U.S. Fish and Wildlife Service and the SCS have very specific but somewhat differing definitions of wetlands, both agencies share three criteria. Thus wetlands:

- 1) are distinguished by the presence of water at some time,
- 2) have unique **hydric** (water-associated) soils that are different from adjacent upland soils, or
- 3) support unique vegetation types that are adapted to wet conditions.

Let's explore some of the common wetland indicators in each of the criteria to determine if an area is a wetland.

### Water Indicators

**Wetland hydrology** refers to the presence of water above the soil surface or within the soil so that it affects the types of soils and plants found in the area (Figure 3). The following indicators provide evidence of periodic standing water or soil saturation:

1) **Standing or flowing water** is seen on the area for seven or more consecutive days during the growing season.

2) **Waterlogged soil.** This is determined by digging a 12-inch deep hole. It is considered a waterlogged soil if:

- water stands in the hole,
- the soil glistens with water, or
- water can be squeezed from the soil.

3) **Water marks** can be seen on trees or other erect objects.

4) **Small piles of debris** can be seen lodged in trees or piled against other objects in the direction of water movement.

### Hydric Soil Indicators

About 2,000 different soils occur in wetlands. (The SCS has a listing of these hydric soils.) Hydric soils were developed under conditions where soil oxygen is limited by the presence of water for long periods during the growing season. The following situations may indicate a hydric soil:

- 1) Soil consists of decomposed plant material (peats or mucks).
- 2) Soil has an 8-inch or more layer of decomposing plant material on the surface.
- 3) Soil has a bluish-gray or gray color at least 10 to 12 inches below the surface.
- 4) Soil has the odor of rotten eggs.
- 5) Soil is sandy and has a layer of decomposing plant material 3 inches below the surface or has dark stains or streaks of decomposed plant material. When the soil from these streaks is rubbed between the fingers, it leaves a dark stain.

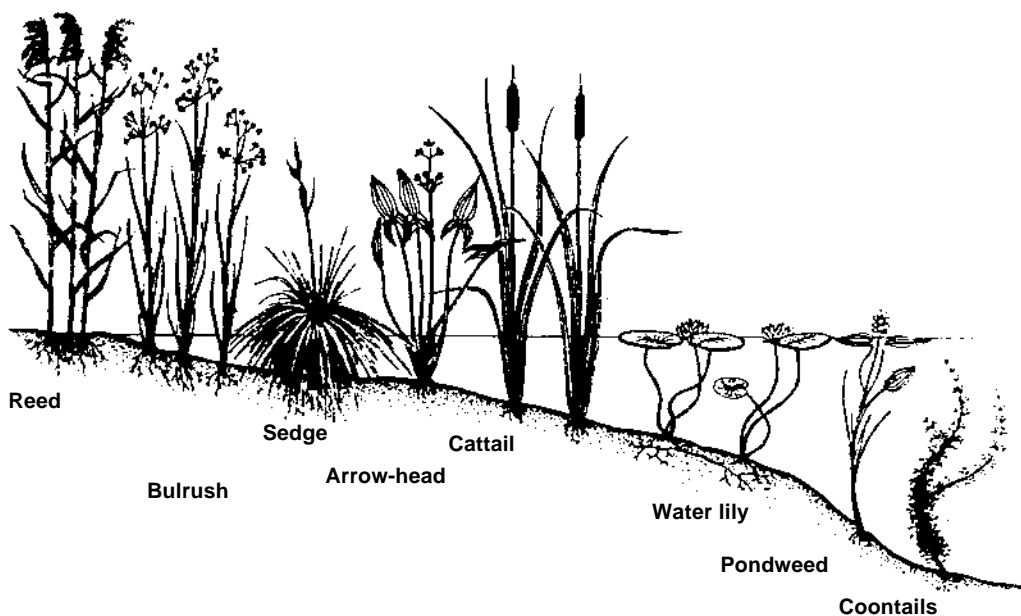

Figure 4. Common plants associated with freshwater marshes in Kansas. The group of plants that have roots in the water and plant stems above water are called **emergent wetland plants**. Plants that are rooted on the bottom and grow in water but do not have stems above the water are called **submergent wetland plants**. The final group of wetland plants not shown are **floating wetland plants** (such as duckweed) that are not rooted on the bottom and float on the surface of the water. Notice how different plants are adapted to different levels of flooding.

## Plant Indicators

About 5,000 different kinds of plants may be found in wetlands. (A list of these plants can be obtained from the SCS or the U.S. Fish and Wildlife Service.) You can usually determine if wetland vegetation is present by knowing a few plant types like cattails, bulrushes, duckweed, willows, sedges, and rushes (Figure 4).

## Wetland Habitats Found in Kansas

In general, there are three major types of wetlands found in Kansas: *palustrine* (marshes and swamps), *riverine* (wetlands associated with rivers and streams), and *lacustrine* (wetlands associated with lakes). In addition, there are wetlands found in other areas including *marine* wetlands (saltwater inter-tidal areas associated with oceans) and *estuarine* wetlands (brackish water areas where freshwater streams enter the sea). These last two wetland types will not be discussed in detail since they obviously do not pertain to Kansas.

## Marshes and Swamps

These wetlands are shallow water areas with very restricted water flow. While **recharge** (water entering the system) can occur quickly when an adjacent river or stream floods, once water enters a marsh or swamp, it tends to stay for a while because there is little or no gradient (that is, the land is flat). Therefore, the associated plant life is adapted to constant or periodic coverage by water.

Marshes are characterized by herbaceous plants, such as cattails, bulrushes, sedges, and arrowheads, in shallow water. Plants found in deeper water include water lilies, pond weeds, and bladderworts. These wetlands vary in size from a few square yards to thousands of acres. Freshwater marshes are often found in some type of landscape depression or the edge of a lake or river.

Swamps, on the other hand, are dominated by woody plants. Swamps vary in size, and some of the largest are associated with major river systems, such as the Mississippi and the Ohio. These river swamps are known as **bottomland hardwood wetlands** because of their large stands of trees. Common trees in Kansas bottomland hardwood swamps include cottonwoods, green ash, pin oak, and silver maple. Shrub species include buttonbush, salt cedar, and willows. Swamps are often wet during part of the year and dry during the remainder of the year. During the wet season (late fall and winter) most of the trees in swamps are dormant.

## Rivers and Streams

Flowing or moving water characterizes rivers and streams. Fast moving streams are found in hilly areas such as eastern Kansas, whereas slower moving streams are found in the west.

Plants and aquatic animals associated with fast moving streams can attach themselves to the bottom or to rocks to keep from being washed downstream. Certain species of algae and snails as well as bottom-dwelling insects are adapted to the relatively harsh environments of these fast moving streams.

The slow moving waters have plant life similar to that found in marshes and swamps. These streams accumulate energy-rich sediments that support a large number of aquatic organisms. It is on these energy-rich areas of occasional flooding where the vast bottomland hardwood forests develop. In areas where flooding is more constant and backwaters more persistent, marshes develop along the shoreline.

Bottomlands are a normal part of a river's development and are formed as the stream periodically floods its banks and lays down layers of silt and sand. These **alluvial deposits** (layers of silt and sand) are important features because they hold temporary water during flooding and release it back to the river channel at a slow rate.

## Lakes and Ponds

The primary difference between a pond and a lake is size. Lakes are usually large, deep bodies of water, whereas ponds are smaller and shallower. Ponds usually have uniform water temperatures, while lakes vary in temperature as the water gets deeper. Most lakes and ponds have shallow water areas along their margins where marshes and swamp forests develop.

Naturally occurring lakes and ponds are rare in Kansas. Most natural lakes or ponds are associated with riverine systems where river channels are cut off from the main current and create marshes and oxbow lakes. Most of the lakes and ponds in Kansas are man-made. Many are created as a result of the U.S. Army Corps of Engineers' flood control structures (dams) or as farm ponds for watering livestock. Some are inadvertently created from other activities, such as mining, quarrying, road building and irrigation run-off.

## How Do Wetlands Function?

### Wetland Ecosystem Dynamics

The plants and animals that interact with each other within a given area make up an ecosystem (see Chapter 3). Within such systems, certain organisms occupy more space and are more abundant (numerically superior). These organisms are called **dominants**. The dominant plants in bottomland hardwood wetlands and sloughs are usually cottonwoods, green ash, or black willow. Slightly drier areas subject to less flooding are often dominated by pin oaks. Such dominants control the amount of light getting to the forest floor which affects the plant species that can occur in



the understory. Just as plants are affected by these differences in light requirements, they are also affected by differing tolerances to flooding. Those species with a high water tolerance are found where flooding is more frequent. Thus, wetland plant and animal species are adapted to environmental conditions that are different from upland or terrestrial species.

Wetland plants and animals are adapted to soils saturated with water and/or periods of flooding. Since such soils have less available oxygen, plants adapted to these conditions develop different and various strategies for survival. For example, water lilies have openings on the upper sides of their floating leaves to allow for gas exchange. Some trees have openings in the bark to allow air to come into the plant, while others have the ability to switch to oxygenless respiration.

Animals have also adapted to wetland conditions. Fish extract oxygen from the water through their gills. Amphibians such as salamanders and frogs spend much of their time on land but must maintain a moist skin in order to absorb oxygen. These animals also come back to the wetland areas to breed and lay their eggs. Many insects lay their eggs in or on the water's surface. Some aquatic insects periodically float to the surface to obtain air bubbles that they use in the same fashion as scuba divers. Thus, animals and plants that live in wetland systems have developed specialized adaptations that allow them to live in these environments (Figure 5).

## Wetland Productivity

Wetlands are among the most productive ecosystems in the world. This high productivity is due to their ability to capture large amounts of the sun's energy and store it. In addition, wetland systems also efficiently recycle the energy that is produced. Let's examine this productivity in more detail.

Energy flow is the movement of chemical energy through a food chain (see Chapter 3). The **grazing food chain** (producer-herbivore-carnivore) is particularly productive in wetland systems. In addition, wetlands have another very important energy system called the **detrital food chain**. This involves those organisms that break down dead, decaying plants and animals. This also is a very efficient food chain, and the efficient functioning of both the grazing and detrital food chains adds to the productivity of many wetlands.

Many Kansas wetlands are also energy-subsidized by periodic water flow that causes a rise and fall of water levels in the system (**pulsing**). This pulsing adds nutrients when water levels rise and makes those nutrients more accessible to wetland organisms when the water recedes. Pulsing also adds oxygen (usually a limiting factor in wetland systems) to the system. In wetland systems where water levels are relatively stable and pulsing is limited, organic matter accumulates, and potential productivity is locked up in the bottom sediments. It is the rise and fall of water that provides for the high productivity of most wetland systems.

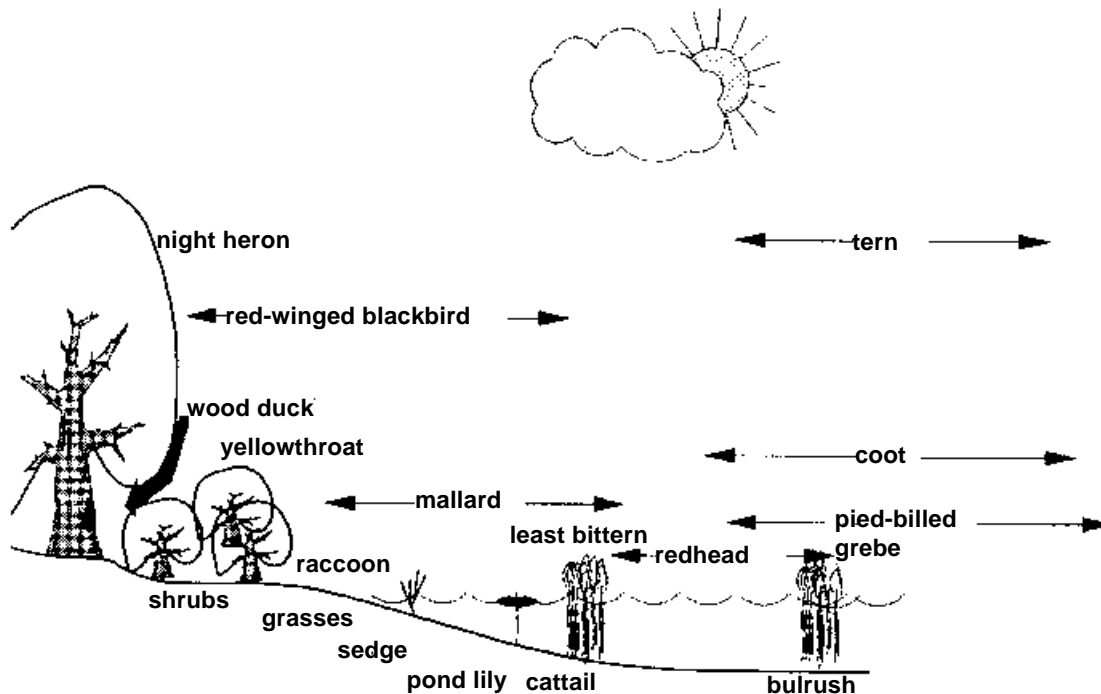

Figure 5. Different plants and animals are adapted to different water depths in a wetland system. See Figure 4 for a diagram of plants adapted to shallow water.

## Biotic Change

An often unrecognized fact is that living organisms can profoundly affect the physical world they inhabit. For example, we have all observed the changes termites bring to their environment. Farmers and suburban landowners are often affected by the changes moles, gophers, and other burrowing animals have on lawns and pastures. On a less obvious level, lichens have the ability to attach to exposed rock and chemically break down the rock to form mineral soil (see Chapter 3). These are examples of biotic change.

Biotic change also occurs in wetland systems. The natural trend toward nutrient enrichment that occurs in ponds and lakes results in a profusion of phytoplankton and zooplankton, which in turn results in an increasingly productive food chain. This productivity is maintained in lakes through the phenomenon of **recirculation**, whereby the lake water overturns.

Recirculation works like this: During the warm summer months, there is a distinct temperature stratification in lakes—a warm layer of water at the surface overlays a much colder layer beneath it. The abrupt difference in temperatures between the layers tends to keep them separated. As the cooler air temperatures of fall come along, the water temperature of the lake becomes more uniform. Mineral-rich water from the bottom tends to rise to the top where it renourishes algae and other forms of life that exist in the light-rich upper water.

This mechanism of recirculation occurs twice a year. It keeps the lake system healthy but ultimately dooms it as well. As organisms die, they settle to the bottom of the lake. Clay and silt particles brought into lakes by streams accelerate this filling-in process (called **eutrophication**). Ultimately, shallow lakes and ponds fill in until they become marshes or swamps. This process is also occurring in Kansas' large reservoirs and will eventually cause their decline.

## Why All the Fuss About Wetlands?

Wetlands are natural resources that have been particularly abused by human activities. More than 48 percent of Kansas' wetlands have been drained, filled, or destroyed. As wetlands become more rare, they become more valuable. The question people usually ask when discussing wetlands is, "What good are they?" This is a usual question asked by people when they see no direct use or value in something. Such is the case with wetlands. Wetlands are thought of as useless waste-grounds or barriers to be made productive or removed. Seen in such a light, wetlands are thought to have only negative values because they:

- 1) *make farming, building, and development difficult;*
- 2) *are full of creatures we do not like, such as mosquitoes and snakes;*
- 3) *serve as "weed banks" full of undesirable plants;*

- 4) *are a source of bad smells.*

This attitude toward wetlands can be illustrated at Cheyenne Bottoms in Barton County. In its early years it was involved in diversion projects and promoted as a recreational area as well as a storage pool for irrigation. There was pressure early in this century to drain the Bottoms so that the area could be farmed. Now managements are underway to restore and enhance Cheyenne Bottoms. Over the years the SCS worked with industry and landowners to drain wetlands in a mistaken attempt to make the land more productive. But, as is often the case, the true value of wetlands was not fully recognized until they become relatively rare. Today our attitude, along with government policy, is changing with our increased knowledge of how wetlands function and the positive values associated with wetlands. Back to the original question of "What good are they?"

## Wetlands Values and Functions

Wetlands have numerous values and functions that help society in general. Their many benefits include:

- 1) *habitat for fish and wildlife,*
- 2) *flood control,*
- 3) *groundwater recharge,*
- 4) *trap for sediments, excess nutrients, and pollutants, keeping surface and groundwater clean,*
- 5) *recreation and greenspace areas,*
- 6) *scientific and educational values, and*
- 7) *human services including food, energy, wood, agricultural commodities, and other items.*

## Fisheries and Wildlife Value

We started the chapter by describing the decline in waterfowl numbers that is directly linked to the loss of wetland habitat. While ducks and geese are important components of wetland communities, other species of wildlife are also directly associated with wetlands. It is estimated that about 150 bird species and more than 200 species of fish depend on wetlands in this country.

In Kansas, some common inhabitants of wetlands are great blue heron, American and least bittern, American coot, dowitchers, yellow legs, spotted sandpiper, marsh hawk, bald eagle, osprey, red-tailed hawk, pheasants, and owls. Common songbirds include the belted kingfisher, red-bellied woodpecker, several species of swallows, sparrows, and warblers. Perhaps the most commonly seen bird in Kansas wetlands is the red-winged blackbird.

Many waterfowl species winter here (see Chapters 12, 13, 14 and 15). Most frequently seen are mallards, blue-winged teal, gadwall, northern pintail, widgeon, scaup, and bufflehead. Canada geese are both residents and winter visitors.

The importance of riparian forests to wildlife cannot be overstated. These areas provide critical winter food and cover for waterfowl. Mast-producing trees associated with these wetlands produce acorns that the ducks will eat. These high-energy foods are necessary to build up body fat stores for the long migration flight to the breeding grounds. Abundant invertebrates in the flooded areas provide the necessary protein to get the birds in shape for the upcoming reproductive season.

Common mammals associated with Kansas wetland habitat include muskrat, beaver, raccoon, mink, coyotes, and white-tailed deer,

Numerous reptiles and amphibians live in or use wetlands, including water snakes, garter snakes, and salamanders. Turtles found in these areas include softshell, painted, mud, and snapping turtles. Common frogs include the leopard frog, chorus frog, bullfrog, and northern cricket frog.

Wetlands are also important for freshwater fish, and many of these species require the shallow water in wetlands for breeding sites. The relatively thick vegetation associated with shallow wetlands provides protection for smaller fish against predatory fish like bass. Highly fertile wetlands can produce up to 300 pounds of fish per acre.

The values of wetlands to wildlife can be only partially calculated in economic terms. The economic impact of the wildlife resource is often overlooked. Nearly one million Kansans took part in some form of wildlife-related recreation during 1985, spending more than \$200 million. The furbearer harvest alone in 1986-87 was valued at \$1.9 million. Most of this income was derived from sales of muskrat, beaver, raccoon, coyotes, and mink pelts, animals intricately linked to wetlands. Perhaps the greatest value of wetland wildlife is the aesthetic beauty and feeling of kinship that people sense from these animals.

### Flood and Erosion Control

Wetlands are very important for flood control (Figure 6). During periods of high water they serve as storage areas. Wetlands can hold the flood waters and release the water at a slower rate, thereby lessening the destructive power of floods. The retention also tends to lower flood crests and reduce erosion caused by flooding.

This ability to lessen the damage caused by flooding is increasingly important as more and more areas are paved over with concrete and asphalt. Concrete and asphalt prevent soil from absorbing water (a process called **groundwater recharge**). This increases the amount of runoff and results in the probability of increased flooding. In addition to flood control in river systems, wetlands also help reduce erosion around lakes. The wetlands and associated plant communities act as a buffer to shorelines when they reduce the impact of strong wave action.

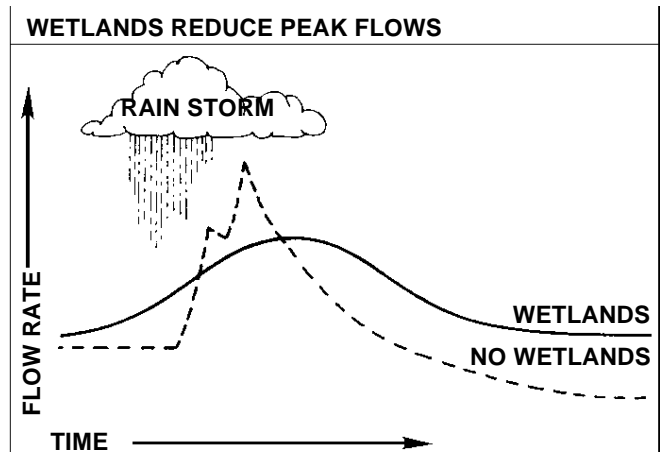

Figure 6. Wetlands help reduce flood damage to property. When rain or snow enters wetlands or when streams overflow their banks, wetlands fill with water and hold it for a period of time. Wetlands hold flood water and release it slowly because the water is delayed (trees, reeds, cattails, or other plants slow the motion), and the water evaporates or is taken up in the roots, stems, and leaves of wetland plants.

### Groundwater Recharge

Wetlands are important in moving water beneath the surface of the soil as well. Wetlands contribute to groundwater recharge in many areas by holding the water until it is absorbed through the soil and into the underlying aquifer. This is a very important function and benefit for those people who rely on local aquifers and wells for their drinking water.

### Filtration of Pollutants

Wetlands have the ability to remove pollutants, excess nutrients, and sediments from the water that enters them. This is partly caused by simple dilution. It also occurs because aquatic microorganisms have the ability to take up mineral nutrients and break down organic matter. While it is possible to overload the system, studies have shown that wetlands can reduce nitrogen and phosphorus levels by up to 60 percent. Wetlands can release nitrogen to the atmosphere as a gas or bury it in sediments that is released at a later time. Because of the complexity of natural wetlands, it is easy to overload these systems with pollutants. However, man-made wetlands, using highly efficient plant species like bulrushes, may be able to absorb much higher levels of nutrients. This may eventually lead to wetlands becoming important parts of municipal waste-treatment plants and mine reclamation procedures.

### Recreation and Greenspace Areas

Wetlands provide numerous avenues for recreation. Whether it is hunting, trapping, sightseeing, birdwatching, or photography, the appreciative use of wetlands has greatly increased in recent years. Many people use wetland areas for passive recreational pursuits, including nature study, jogging around the perimeter, canoeing, photography, or artistic inspiration. One of the emerging values of wetlands is for greenspace or open areas where people can escape the fast pace of city or urban living.

The most common recreational uses of wetlands have been hunting and trapping. Millions of people throughout this country enjoy hunting ducks, geese, and other wetland wildlife species every year. Without wetlands, much of this hunting might not exist. Many hunting clubs in Kansas and throughout North America have preserved valuable wetland habitat that might have been lost to drainage.

In addition, waterfowl hunters must purchase a hunting license and a Migratory Bird Hunting and Conservation Stamp (duck stamp) before taking to the field. These funds are used to preserve wetland habitat. Hunter monies are the primary source of funds for the KDWP, which is responsible for managing some wetland habitats in the state. Proper management by all landowners ensures adequate wildlife for people.

### Scientific and Educational Values

The importance of wetlands as scientific, educational, and cultural treasures also needs to be explored. Wetlands are unique outdoor laboratories where scientists can learn new and useful things for society at large. Early scientific studies using wetland systems as a model provided the framework for understanding these concepts:

- *how ecosystems function,*
- *how energy moves through ecosystems,*
- *how plants can adapt to changing water levels,*

- *how wild animal populations fluctuate and respond to change, and*

- *how wildlife species behave.*

Regardless of their size, wetlands serve as outdoor classrooms where teachers can demonstrate the workings of nature.

### Human Services Value

Wetlands provide numerous products that humans use either directly or indirectly. As an obvious example, wetland wildlife that are hunted or trapped are used for food and clothing. Beyond these obvious products, wetlands produce such other important products as energy (firewood, peat, cattails), fishing bait (minnows, leeches), food (bullfrogs and many of our finfish and shellfish from coastal regions), specialty plant foods (wild rice, cranberries), timber for wood products, dried plants for flower arrangements, and live insectivorous plants. The list could go on and on.

Many agricultural benefits are also associated with wetlands. One of the most obvious is using wetland vegetation for grazing or haying. Many wetland plants have high nutritional value for domestic livestock. In the coastal areas from Florida to Texas, marsh hay is recognized as some of the best livestock forage available.

Farmers receive other benefits from wetlands. These may be in the form of groundwater recharge for livestock watering, filtering pollutants from the water supply, trapping of sediments, and runoff from plowed ground before it can enter local water supplies. The list can go on and on.

In conclusion, wetlands play important roles in the natural and physical world. These roles, functions, and values may be in the form of flood storage, nutrient recycling, water purification, and wildlife habitat, to name just a few. We are finally realizing these important values and taking steps to protect the remaining wetlands and to restore those that have been damaged.



*Duck numbers have dropped by half since World War II. The decline in waterfowl numbers is directly linked to the loss of breeding, migrating, and wintering habitat.*



*Wetlands are important habitats for a variety of game (raccoon, blue-winged teal, northern shoveler, Canada goose) and nongame (great egret) wildlife species.*



*Wetland drainage to increase the amount of agricultural land available for crops or commercial, industrial, or urban development is the most serious threat to breeding, migrating, and wintering waterfowl habitat.*

## Questions for Chapter 10

1. What is the primary reason duck populations have dropped by half since World War II?
2. Describe why it is important to save our remaining wetlands based solely on the amount of wetland habitats that have already been destroyed.
3. What three criteria do federal agencies use to identify wetland habitats?
4. What three general types of wetland habitats are found in Kansas?
5. What soil, plant, and hydrology characteristics can help you to identify if an area is a wetland?

### Questions for Chapter 10 (continued)

6. Describe in a general way how wetland systems function or operate.

7. List and briefly describe the important reasons we should preserve and manage our remaining wetland habitats.

Name \_\_\_\_\_



## Chapter 11

# Wetland Management

*Jeff Powell and Richard A. Olson*

## Developing Artificial Wetlands

### *Selecting Artificial Wetland Locations*

Potential wetland site selection must include considerations of soil types, topography, drainage patterns, proximity to adjacent upland cover, access for earth moving equipment, and areas requiring minimal construction expense.

Soils should hold water without excessive seepage. Clays or fine silts are particularly desirable. Sandy soils should be avoided unless there is an underlying hardpan of clays or fine silts. Adding bentonite or other clays to seal a seeping wetland basin will inflate construction costs, but may be necessary on some sites.

Natural depressions where water accumulates after spring thaws and rainstorms are prime sites for constructed wetlands. The amount of excavation required on such sites is minimal, and native wetland vegetation is often present for quick re-establishment. On previously drained sites, existing native upland vegetation may offer some immediate nesting and protective cover for wildlife.

If possible, select a site adjacent to upland cover such as shelterbelts, hedgerows, woodlots, heavy grass-covered areas, or shrubby patches to provide protective cover corridors for wildlife traveling to water. Open shoreline areas can be fenced to provide a livestock water gap.

Selected sites should provide easy access routes for heavy equipment required in excavation work. Difficult access for heavy equipment will increase construction costs.

Finally, the wetland project must be planned within allowable budgets. Small projects often can be accomplished with tractors and other equipment available on most farms or ranches. Larger projects requiring heavy equipment, large labor commitments, and substantial materials require correspondingly greater expenditures and should be planned carefully.

### *Design Considerations For Artificial Wetlands*

Artificial wetlands are constructed by three basic methods: 1) erecting a dam within a natural drainage route to impound accumulated runoff water (stockdam), 2) excavating a basin with earth-moving equipment to collect excess water (dugout), and 3) creating small potholes with commercially available explosives to collect water.

Successfully constructed stockdams depend on drainage patterns based on local topography, watershed contribution,

and the resistance of basin soils to seepage and dam leakage. Traditional dugouts, primarily constructed for livestock watering, usually consist of a slot trench with spoil material piled on either side (Figure 1). This design, however, is not aesthetically attractive or especially productive for wildlife.

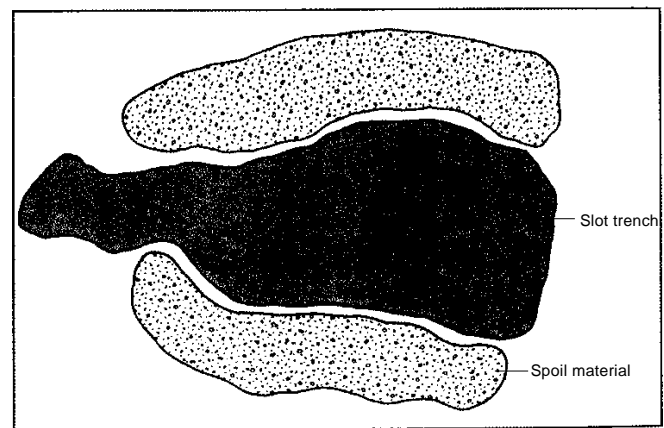

*Figure 1. Dugout: one type of artificial wetland providing wildlife habitat.*

Pothole blasting commonly results in a uniformly round water basin with impaired wildlife habitat potential. All 3 artificial wetland types can be improved to provide maximum benefits for wildlife and livestock.

Factors to consider in improving the design of artificial wetlands for wildlife and agriculture include basin physical characteristics, vegetation establishment and diversity, water quality and control, and adjacent land uses that impair wetland functions. Soil Conservation Service personnel in your area should be consulted before initiating any construction activities to ensure that basin, dam, spillway, and water control structure designs meet legal requirements for safety and storage capacities.

**Basin contours.** Both shallow-pitched and steep-sloped shorelines should be excavated in integrated combinations to provide diversity in shoreline water depths. Bottom contour designs should provide an approximate ratio of 1 part temporary, 2 parts seasonal and semipermanent, and 1 part permanent wetland zones in a concentric arrangement.

Steep-sloped shorelines should not exceed 1:5 slope (a 1 yard rise for each 5 yards horizontal distance) to maintain

substrate stability. Shallow pitched contours should approach a 1:30 slope to provide broad zones of temporary or seasonal water for enhanced wetland vegetation establishment.

Shallow shorelines will eventually support wet meadow, emergent, and submerged aquatic vegetation. Steep-sloped shorelines will inhibit wetland vegetative development and provide open water areas. Maximum wetland water depth should not exceed 4-8 feet for optimum aquatic plant development. Where fish stocking is planned, an area with minimal depths of at least 12-15 feet is required to avoid winter kill.

**Basin shape and shoreline configuration.** Usually, prevailing topography and landform will largely determine the shape, orientation, and shoreline configuration of an artificial wetland. However, the following guidelines should be considered whenever possible in designing basin shape and shoreline configuration:

To promote shoreline irregularity, the basin should be excavated in a crescent, kidney, oakleaf, dogleg, or other appropriately varied configuration rather than a uniform circular or rectangular shape. Irregular shorelines produce high ratios of shoreline length to open water (edge effect), maximizing the habitat diversity preferred by waterfowl. The resulting small bays, peninsulas, and shoals attract waterfowl and provide aesthetic values.

Broadly-shaped basins will accommodate a greater variety and interspersion of bottom contours compared to long, narrow wetlands, adding additional habitat diversity.

The wetland should be oriented with shallower areas on the windward side parallel to prevailing winds to minimize shoreline erosion and reduce degradation of wetland plant communities in shallow water areas from wave action.

**Basin size.** Excavated basins must be designed to accommodate maximum potential runoff from spring thaws and peak rainstorms. Outer concentric temporary and seasonal wetland zones should be large enough to hold these peak water levels. The surrounding watershed area and amount of estimated runoff during peak flows must be determined to plan basin size.

Local SCS personnel can provide assistance in recommending basin storage capacity. Minimum recommended basin size (in surface acres) is estimated by dividing the estimated acre-feet of water storage by 3.

Recommended proportions of wetland habitat zones: Most wetlands are classified as temporary, seasonal, semipermanent, or permanent, based on water depth and duration. Within an individual wetland, these classifications also describe concentric vegetation zones where the central permanent zone is subsequently surrounded by semi-permanent, seasonal, and temporary zones. The preferred

proportional ratio of temporary, seasonal/semipermanent, and permanent wetland types for waterfowl is 1:2:1. For example, for each acre of permanent wetland there needs to be 2 acres of seasonal/ semipermanent wetland and 1 acre of temporary wetland.

Recommended proportion of upland to wetland habitat: Adjacent upland cover is required by waterfowl and other wetland wildlife for nesting, feeding, resting, and brood rearing. Ideally, upland cover area should equal the total wetland area, with adequate residual vegetation for nesting and protection. Upland areas interspersed with shrubs and trees provide variety in cover strata and offer optimum wildlife habitat. Seeding and planting of supplemental herbaceous and woody plants can improve upland habitat quality.

**Islands.** Islands provide additional habitat diversity by increasing shoreline to open water edge. Nesting wetland birds are attracted to islands for protection from terrestrial predation and disturbance.

During construction, excavated material should be used for islands to lower construction costs associated with transporting material from the basin. Settled height of islands should be at least 2 ft above the normally expected spring water level. Linear islands with irregular shoreline contours, approximately 0.25 ac size, 50 ft wide, and 200 ft long with shallow-sloped shorelines are recommended for maximum wildlife value. Since most puddle ducks such as mallards, teal, and pintail nest within 25 ft of the shoreline, optimum island width is at least 50 ft.

Islands should be located in year-long permanent water areas exceeding one foot in water depth in protected, upwind sides of the basin away from excessive wave or ice action, and at least 150 ft from the shoreline. Rip-rapping, or layering with rock may be required to prevent erosion of islands constructed with soil too poor for vegetation establishment. A horseshoe-shaped configuration oriented toward prevailing winds will break initial wave intensity and provide a small bay-like area on the leeward side for protection (Figure 2). One island per 4 acres of surface water is recommended with spacing no closer than 100 yds apart.

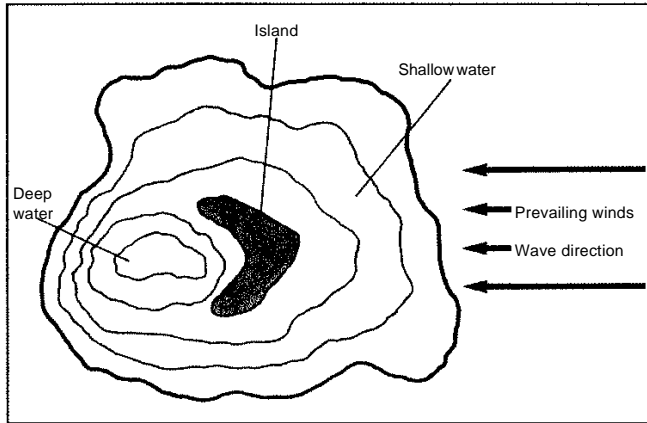

Figure 2. Island design and location for wind and wave protection.

**Water quality.** Artificial wetlands should be located where year-round water supplies maintain continuous inflow/outflow flushing to avoid stagnation and possible wildlife disease problems. Wetland vegetation established near the upper end of an artificial pond at the source of water inflow will trap sediment to improve water quality and extend the useful life of the wetland for wildlife and livestock.

Likewise, offsite watering access points for livestock will reduce sediment deposition in the wetland to maintain water transparency for good aquatic plant growth. Maximum aquatic vegetation production occurs when water transparency is at least 5 ft and total dissolved solids (TDS) is less than 500 parts per million.

Limnological conditions also have a definite influence on duckling use of saline lakes common in much of the arid West. Salt concentrations are altered by changes in water volume and construction-induced hydrologic barriers that change the natural water flow and mixing. Ducklings are closely associated with fresh inflow from spring seepage or adjacent wetlands of low salt content. Ducklings that use sheltered bays with chemically stratified water are able to feed on fresh water.

Sulfates are often the most dominate anions and sodium, magnesium, and potassium the common cations. Ducklings can not tolerate salt concentrations in saline lakes that exceed 20 mmhos/cm unless fresh water is also available.

Salt concentrations of 17 mmhos/cm significantly reduce duckling growth. High levels of magnesium and sulfates may cause greater stress on birds than equivalent concentrations of NaCl that are processed by the supraorbital salt glands.

Saline lakes are common where spring flows fill the lake and evaporation then increases the salt concentration. Spreading manure relatively low in salt (i.e., from other than feedlots) on the dry soil near the water during the low-water

periods in the summer and fall may help neutralize or filter out some of the salts.

**Water control structures.** Devices built and installed at water inflow and outflow locations in the wetland, called water control structures, can be used to control water levels within the basin. Plans for water control structures, placement, costs, and anticipated water level management must be considered prior to construction activities.

Control structures, when installed correctly, provide a mechanism to achieve desired aquatic plant community development for maximum wildlife and livestock values. Your local Soil Conservation Service office can provide assistance in designing and recommending water control structures for your wetland.

**Adjacent land uses.** Artificial wetlands should be located to avoid impacts and disturbances from adjacent upland areas. Toxic runoff from herbicides, pesticides, and fertilizers and/or excessive agricultural activity disturbances may inhibit wildlife use of the artificial wetland.

### Wetland Construction

Before starting construction, wetland development should be planned by sketching a cross-sectional view of basin contours and slopes, and drafting an aerial view of surface shoreline configuration, island development, upland cover areas, fencing (if any), topsoil stockpile sites, water control structure location, access routes, observation points, and other physical developments. Remember to consult with the local Soil Conservation Service to verify that your construction design meets legal and safety requirements.

Also contact the State Engineers Office for clearance on water rights, as well as the Army Corps of Engineers for a 404 permit to move soil or manipulate water movement. Adequate preconstruction planning will prevent many unanticipated problems later and reduce costs.

During initial excavation, salvaged topsoil and subsoil should be placed in locations convenient for later respreading on islands, dikes, and other sites where needed (Figure 3). Prolonged storage of topsoil from natural upland or wetland areas should be avoided because survival of seed and root stocks from the aquatic and upland plants within may be impaired. The later respreading of salvaged topsoil may promote rapid vegetation redevelopment on the site. Seeding or introducing root stocks will provide the quickest way to establish aquatic vegetation.

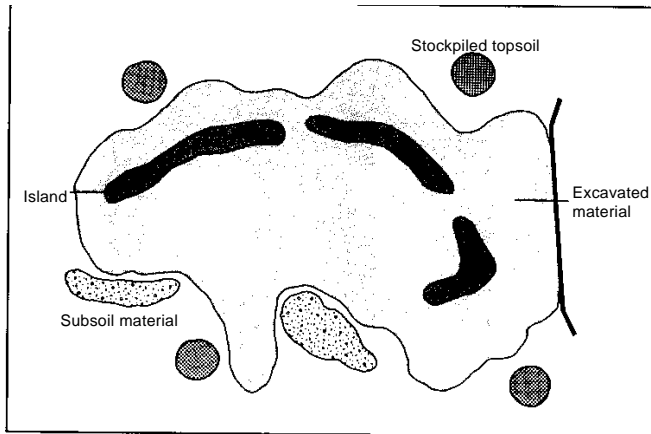

Figure 3. Construction design for creating an artificial wetland.

Subsoil movement from excavated areas should be minimal to reduce construction time and costs. Subsoil from a deep water site could be used to construct islands, dikes, and wildlife loafing sites in the proximate vicinity, thus eliminating the removal of all material from the basin.

Following the initial rough excavation, the constructed surface should be smoothed to eliminate abrupt shoreline slopes, and impoundment bottom soils should be packed before replacing stockpiled topsoil. Relatively flat areas should be graded where livestock watering is planned to provide easy access and promote preferred routes. Islands and dikes can be stabilized with planted vegetation.

Wetland construction should be initiated in early September when soils are dry enough to be properly handled by earth-moving equipment. Excavation and contour development can be accomplished with bulldozers, bobcats, backhoes, and/or front-end loaders. On basin subsoils with moderate to large amounts of gravel, sand, or other coarse textured material, a 6-inch layer of clay or sealant must be spread to minimize seepage.

### Landscaping, Seeding, and Planting

Before seeding and planting, final landscape work must be completed by smoothing abrupt areas and developing any desired special features such as observation points and picnic spots.

Seeding constructed landforms such as islands and dikes, and disturbed upland areas with grasses, legumes, shrubs, and trees will enhance the area for wildlife (Table 1). Seeding reduces weed problems in adjacent croplands by preempting natural weed development, and will also retard initial erosional soil loss.

Table 1. Selected wetland plants for enhancing water-fowl habitat.

#### Brood Cover

Bulrushes *Scirpus* spp.  
Cattail *Typha* spp.  
Sedges *Carex* spp. Whitetop *Scolochloa festucacea*  
Bur reed *Sparganium* spp.  
Rush *Juncus* spp.

#### Nesting/Escape Cover

Reed canarygrass *Phalaris arundinacea*  
Redtop *Agrostis alba*  
Garrison creeping foxtail *Alopecurus arundinacea*  
Barnyard grass *Echinochloa crusgalli*  
Switchgrass *Panicum virgatum*  
Orchardgrass *Dactylis glomerata*  
Bulrushes *Scirpus* spp. Cattail *Typha* spp.  
Wheatgrasses *Agropyron* spp.  
Alfalfa *Medicago sativa*  
Sweet clover *Melilotus officinalis*  
Smooth brome *Bromus inermis*  
Retired cropland/ungrazed or moderately grazed areas  
with residual vegetation

#### Food Species

##### Flooded Areas

Pondweeds *Potamogeton* spp.  
Sago pondweed *Potamogeton pectinatus*  
Wild millet *Echinochloa crusgalli*  
Sedges *Carex* spp.  
Smartweed *Polygonum* spp.  
Alkali bulrush *Scripus maritimus*  
Widgeongrass *Ruppia maritima*  
Duckweed *Lemna* spp.  
Coontail *Ceratophyllum* spp.  
Spike rush *Eleocharis* spp.  
Muskgrass *Chara* spp.

##### Dryland Areas

Corn *Zea mays*  
Wheat *Triticum aestivum*  
Barley *Hordeum vulgare*  
Proso millet *Panicum miliaceum*  
Foxtail millet *Setaria italica*  
Cereal rye *Secale cerceale*  
Clover *Trifolium* spp.  
Oats *Avena sativa*

On shoreline areas where wave erosion may exist and there is no shoreline vegetation, tubers of hardstem bulrush and cattail can be planted to increase soil stability. Tubers should be collected from the immediate vicinity and planted in late spring at 12-18 inch intervals covered with 3-6 inches of soil. Plantings should be at the water line to ensure

adequate moisture. Both plants furnish waterfowl cover and bulrush seeds are relished by most waterfowl.

Upland nesting sites and islands should be seeded for a dense nesting cover mixture that includes wheatgrasses, yellow sweet clover, and alfalfa. In established grass stands, mulching with ripened seed hay can be used to convert ordinary grasslands into dense nesting cover. This technique may be convenient for landowners who have established haying operations.

Planting shrub seedlings in several well-dispersed clumps within upland grass meadows is recommended for optimum habitat diversity. When located near areas of frequent human disturbance, hedgerow and/or shelterbelt plantings will minimize the impact to wildlife utilizing the wetland (Figure 4).

Strategically placed shrubs and trees can also add snowdrifts and extra spring runoff for ponds with a relatively low watershed:pond size ratio. Grass and legume seedlings should be initiated in late fall before the first snowfall or early the following spring. Shrub and tree seedlings are best planted early the following spring in frost-free soils.

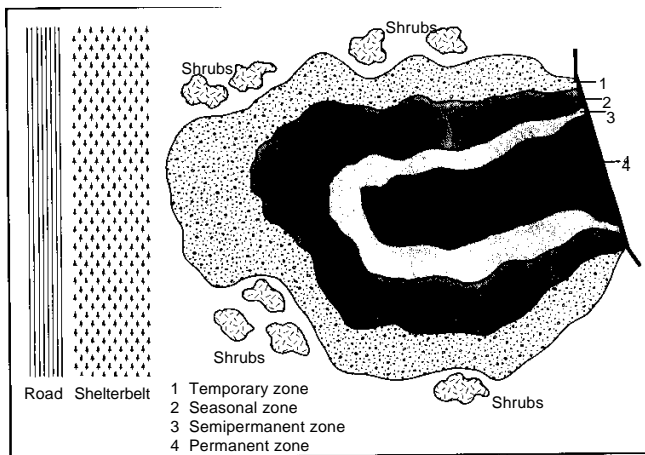

Figure 4. Landscaping the wetland to enhance wildlife use.

Waterfowl nest placement is significantly related to amount of vegetation screening. Cover density appears to be important to nesting hens as vegetation screens nests from potential avian and mammalian predators and from harassment by other nesting hens and drakes. The density of waterfowl nests are frequently greatest in thick shrub with moderate numbers in open shrub and a relatively few in grassland. In most cases the density of the vegetation screen is much more important than the plant species producing the screen.

Livestock should be fenced out of newly seeded areas for the first two years to allow adequate stand establishment. Periodic moderate grazing is recommended as a manage-

ment tool to maintain plant vigor and production after stand establishment. However, care should be exercised to prevent overgrazing, excessive trampling, and/or bank sloughing due to heavy livestock use. Judicious livestock grazing management will provide grazing opportunities while maintaining nesting habitat in areas near wetlands.

The age of the artificial pond also has a definite effect on waterfowl use. Although breeding pair use is primarily a function of pond size, brood use is influenced principally by the availability of food and cover. In a study of Montana ponds of different ages since construction, brood densities were highest on ponds with emergent vegetation covering over 30% of the area, submerged vegetation covering over 20% of the area, and with less than 10% of the shoreline bare.

### *Surface Mine Impoundments as Wildlife and Fish Habitat*

Water impoundments created after surface mining has ended are common throughout much of the northern High Plains and western United States. Past research has described the habitat features of livestock watering impoundments selected by waterfowl, and much of this information may be extrapolated to surface mining impoundments. Waterfowl production of surface mine impoundments will depend on how well three habitat requirements are met: 1) feeding areas for breeding adults, 2) nesting cover, and 3) brood rearing areas.

Surface mine impoundments to be managed for waterfowl should have surface areas between 1.0 and 10.0 acres. Breeding waterfowl pairs, as well as hens with broods, appear to prefer ponds with greater shoreline length. Shoreline length is related both to the size of an impoundment and irregularity of the shoreline created by peninsulas and inlets. The minimum shoreline development (shoreline length divided by circumference of a circle with equal area) index on ponds for waterfowl should be 2.2. Impoundments with 1.0 acre and 10.0 acres of surface area should be designed with at least 1,600 feet and 5,100 feet of shoreline, respectively.

Impoundments or ponds with several temporary, semipermanent, and permanent wetlands in the immediate vicinity have greater use by waterfowl. The best waterfowl habitats contained about 5-15 wetlands of various sizes and shapes per mi.<sup>2</sup>

Although this density may not be achievable in many areas, it is an indication that "more is better." Higher densities of wetlands also results in higher use by waterfowl broods of livestock watering impoundments, probably because the area attracts more breeding pairs.

Shallow, temporary wetlands provide a source of aquatic invertebrates sought by adult ducks in the spring. These invertebrates are important to the breeding physiology of dabbling ducks. Abundance and dispersion of aquatic

invertebrates influence the numbers and habitat selection patterns of waterfowl.

Waterfowl use of impoundments is greater where diverse aquatic vegetation communities are interspersed with open water. Brood-rearing ponds should contain habitats typical of a “deep marsh” until at least mid-August. Mallard broods appear to prefer impoundments with emergent stands of roundstem bulrush, spikerush, and smartweed.

Management of impoundments for waterfowl should be directed at maintaining adequate stem density of aquatic vegetation in shallow areas. Submersed vegetation provides habitat for aquatic invertebrates and livestock watering impoundments with extensive stands of submersed vegetation have greater use by waterfowl broods. Since use of man-made impoundments by duck broods is greater on ponds with higher densities of benthic invertebrates, impoundments should also be managed to maintain high densities of benthic organisms.

Aquatic plant communities can be managed by managing the depth of the water. Emergent species of vegetation, except “hybrid” cattail, are killed at water depths greater than 2.0 ft, and 2.5 ft of water appears to thin out “hybrid” cattail stands. If dabbling ducks are the management objective, impoundments should be between 1.0 and 6.5 ft deep, and less than 2.0 ft deep over 30-70% of the pond area; for diving ducks the depth should be between 2.0 and 8.0 ft and average 3.5 ft.

The abundance of nesting cover is related to waterfowl use of ponds; intensive grazing of pastures surrounding ponds results in decreased waterfowl breeding pairs. Ducks and geese readily nest on islands, sometimes in very high densities, if they are secure from predators. Creating islands in surface mine impoundments will therefore improve the quality of the nesting habitat for ducks and geese. Islands in impoundments less than 50 ac in size should be 20-40 ft across. Dense grass or brushy shorelines are also preferred by waterfowl broods.

By reducing slopes and creating irregular shorelines with inlets and peninsulas and then maintaining adequate shoreline vegetation, most surface mine impoundments can become valuable wildlife habitat. If aquatic or shoreline vegetation does not become established readily, transplants can be used to start development of vegetation communities.

In summary, suitability of reclamation impoundments depends on the kind of bottom material, quality and amount of water available, shoreline slopes, depth and topography of the basin. Shallow, 2 to 3 ft deep, areas over about 30% of the pond area and in irregular shapes are essential for both emergent and submerged aquatic plant growth. Islands should be constructed on upwind sides of the pond to minimize wave and ice action. One island per 4 acres of surface water and no closer than 100 yds apart should be

provided. Shoreline areas should have a 5:1 slope to minimize erosion problems; however, islands should have a minimum of 3:1 slope.

**Benefit/Cost Ratios**

In 1984, J.T. Lokemoen published a study in which he calculated the economic efficiency of various management practices that enhance waterfowl production in the Northern Plains (Table 2).

In general the management practices included establishing introduced grass-legume cover and native grass cover, construction of earthen islands (e.g., 0.1 acre in size) and rock islands, predator reduction, construction of nest baskets, predator-proof electric fences around nesting cover, and construction of impoundments and level ditches (e.g., potholes, dugouts). Construction of earthen islands and predator management were the most productive practices, but not necessarily the most cost efficient. Predator reduction in established grass-legume cover was both highly productive and relatively low in cost efficiency.

**Table 2. Economic efficiency of practices that enhance waterfowl production.**

<b>Management Practice</b>	<b>Cost per Fledged Young</b>	<b>Fledged per Unit</b>
Grass-legume cover	\$ 7.89	\$ 0.36/acre
Native grass cover	24.05	0.20/acre
Man-made islands	223.00	4.79/island
Small rock islands	23.26	0.43/island
Predator management at grass-legume cover	3.37	3.53/acre
Predator management at mixed farmland	2.00	0.06/acre
Nest baskets	8.54	0.78/basket
Electrical predator fences around cover	2.38	4.23/acre
Impoundment construction	129.77	1.67 pairs attracted/acre
Level ditch ponds	76.55	8.41 pairs attracted/acre of pothole

Both production and cost efficiency should be considered by individual ranchers. If the development budget is limited and some waterfowl already use an area, then the cost efficiency of a practice may be the major consideration. However, if there are relatively few waterfowl present in the

area and a rancher wants to attract sightseers and photographers, a relatively expensive practice (e.g., earthen islands) that produces a large number of nesting ducks and geese may be cost-effective in terms of a commercial wetlands recreation operation.

In addition, the relative benefit of a waterfowl production practice (e.g., impoundment construction) to other recreation activities (e.g., boating, fishing, swimming) and normal ranching practices (e.g., livestock water, irrigation) should be factored into the benefit:cost analysis.

In another benefit:cost study, R.M. Hopper reported the relationships among waterfowl use, size and cost of 84 potholes blasted in eastern Colorado between 1968 and 1970. He compared the effects of 25-, 50-, 75-, and 150-lb charges of AN-FO (mixture of ammonium nitrate fertilizer and fuel oil) dynamite.

Smaller charges were more efficient in surface area per cost, but ducks used the larger openings much more. Therefore, 75- and 150-lb charges are recommended. The 75-lb charge was most efficient in regard to cost per duck visit and number of duck visits per 100 ft<sup>2</sup> of surface area. The percentage of total duck visits by increasing size of charge was 9.1, 13.3, 34.5 and 43.1%, respectively. The average costs (in 1970 dollars) per 100 ft<sup>2</sup> of surface area created and total surface created by each charge was as follows:

Surface Area (in feet <sup>2</sup> )	Size of Charge (in pounds)	Cost (in dollars)
200	25	4.87
300	50	7.11
570	75	11.47
850	150	18.81

## Wetlands Management

### *Manipulating Water Levels*

Aquatic vegetation requires periodic flooding and drawdown to maintain community vigor and productivity. Drawdowns expose shoreline mudflats allowing 1) accumulated organic matter to decompose and release nutrients for future plant growth, 2) germination of dormant aquatic plant seeds, 3) enhanced availability of aquatic seeds for feeding waterfowl, and 4) stimulated production of aquatic invertebrates used as food sources by waterfowl. Long-term flooding will prevent new wetland plant establishment and result in over-mature, decadent vegetation of little wildlife value. Wetland plant density and diversity will decline with prolonged flooding.

Natural wetlands experience cyclic seasonal water level fluctuations from spring runoff and over-summer drawdown due to evaporation and plant transpiration. Water control

structures in artificial wetlands allow the landowner to simulate naturally occurring water level fluctuations. Ideally, artificial wetlands should have two drainage outlets: an uncontrolled, automatic slow-release overflow pipe to prevent major flooding during excessive runoff or precipitation, and a major valve-controlled drain with the ability to drain the entire wetland. The valve-controlled outlet should be located where it can completely drain temporary, seasonal, semipermanent, and permanent open water areas. Soil Conservation Service personnel should be consulted to provide specifications on construction of water control structures.

Prescribed drawdowns on artificial wetlands should be planned to permit maximum water availability for spring migrating waterfowl while still allowing enough time to encourage aquatic plant germination and seed production before fall frosts. These periods depend on local growing season length.

Assuming the availability of adequate water supply throughout the growing season, prescribed drawdowns should be initiated in early to mid July, with enough time allowed for reflooding by mid to late September. This allows time for germination and re-establishment of new aquatic vegetation while providing water for migrating waterfowl. Drawdowns can be implemented annually or at other yearly intervals depending on the desired goal of vegetative cover and vigor to maintain healthy plant communities.

During spring runoff, water will rapidly cover the outer temporary and seasonal wetland zones (Figure 5). A prescribed drawdown will gradually expose the substrate within these outer zones, permitting germination of new aquatic vegetation.

Slow drawdowns, in comparison to rapid drawdowns, generally produce vegetation of greater density and diversity without impacting wildlife use. Periodic rainstorms during drawdown will create small water level fluctuations beneficial to aquatic plant establishment. The major valve-controlled outlet should be closed by mid to late September to permit refilling before migrating waterfowl arrive.

Optimum aquatic vegetation production occurs when yearly drawdowns expose the outer temporary and seasonal wetland zones coupled with a complete drawdown to expose semipermanent and permanent open water substrate once every 5 to 7 years (Table 3). Maintenance on drainage valves and outlets can be completed during the total wetland drawdown period.

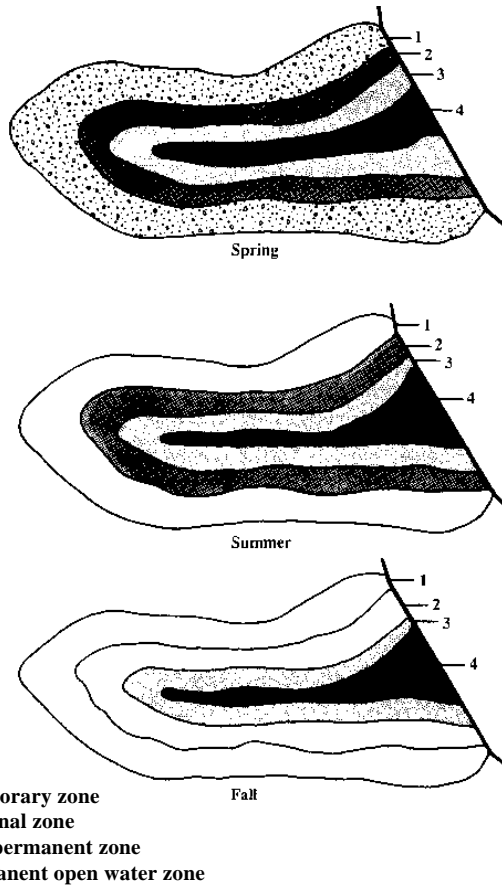

Figure 5. Wetlands illustrating exposed zones due to drawdowns.

**Table 3. Basic wetland management principles.**

- The most diverse and greatest biomass of aquatic vegetation production occurs when water transparency is at least 5 feet, minimum water level fluctuations occur through spring and fall, and water quality is maintained.
- Maintenance of good water quality is important to prevent excessive stagnation, disease outbreaks, and algae blooms. Rules of thumb include maintaining good water interchange through all shallow water wetland areas especially during ice-free periods, and never exceeding 5,000 parts per million in total dissolved solids (TDS) (less than 500 ppm is most productive, 500 to 2,000 ppm is good to fair).
- If the area you are improving or developing already has aquatic submergents or emergents in the system, or did in the past, rarely do you need to introduce these plants. Generally a response occurs within three years of inundation, provided conditions for the period of flooding are achieved.
- In planning a wetland consider including mudflats, gravel bars, etc. for small wading birds.

- Avoid promoting water regimes in wetlands that cause excessive encroachment of open water areas by tall emergents and phreatophytes such as salt cedar.
- Rule of thumb is to not exceed 30-40% of tall emergents interspersed in open water areas.
- The evaporative surface area relative to water inflow governs TDS buildup more than soil alkalinity.
- Different emergent species respond to different periods of over water soil covering and different periods of soil water saturation. This is especially important in establishing desired species, emergent plant communities, and the perpetuation of these communities.

### The Two-Pond System

In watersheds where evaporation and/or siltation is high, it may be worthwhile to build an upper and lower pond in the same drainage. The lower pond is the first priority pond with a constant level of good quality water. The lower pond and adjacent upland is then used for nesting birds and broods, fishing, picknicking, swimming, livestock (piped through the dam to a tank below the dam) and big game water. Fencing only the lower, smaller pond will maximize nesting cover, and minimize fencing costs and the number of cow dung pats the recreationists step in and their dogs and kids roll in.

The upper pond serves as the siltation and feeder pond. The upper pond receives most of the direct flow from spring runoff and the extra water flows over the upper pond's spillway and fills the lower pond. The total capacity of both ponds should be such that the initial runoff fills both ponds. Sediment in the initial and possibly succeeding runoff events then settles out in the upper pond before water flows into the lower pond. A drawdown pipe in the upper pond should allow water to feed into the lower pond through a pipe or via the drainageway at the same rate as evaporation would lower the water level in the lower pond.

In addition to serving as the siltation and/or feeder pond, the upper pond also dries up in the summer producing a mass of ephemeral (usually weedy) vegetation. If there are no fall rains, water can then be pumped from the lower pond to the upper pond, flooding the upper pond to a shallow depth over a large expanse. With this in mind, the upper pond should be constructed to have a relatively level bottom over a large area. In this case, a little water goes a long way.

### Beaver and Beaver Ponds

Although beaver are not always held in high esteem by farmers/ranchers, beaver are nature's engineers and can be used to advantage by a commercial wetland recreation operator. Whereas the state engineer's office or the Corps of Engineers may not grant additional water rights or dam



construction for wetlands of ponds, the natural action of beaver are not often subject to regulatory agencies.

Most permanent riparian areas usually produce shrubs and trees such as willows or cottonwood for beaver food and dam construction if livestock and big game browsing is not excessive. In riparian areas without natural woody vegetation, it may be worthwhile to fence off potential beaver sites. Fencing alone is often enough to allow natural establishment of native beaver foods, such as willow and cottonwoods. If, within the first or second year after fencing, you do not see natural establishment on woody vegetation, willows can be transplanted into the enclosure.

If beaver are in the area, they usually migrate to good quality habitat as soon as the woody plants are large enough to provide adequate food and building materials. If beaver do not migrate into the enclosure, many neighbors are only too happy to allow you to live-trap some of their beaver. Assistance may also be available from state fish and game departments. If the fish and game departments are not willing to actually provide you with beaver, they may provide advice on where to find beaver and how to trap them.

If upstream beaver ponds are incorporated into a multi-pond system, their dams may be blown (if permitted by state laws) in the summer to provide additional water for downstream artificial ponds.

### ***Old River Channels or Oxbows***

Old river channel and oxbows can become permanent wetlands or beaver ponds by diverting water from stream channels directly into dry river channels via ditches, assuming the state engineer's office gives approval. These depressions will hold enough water to develop both emergent and submerged aquatic plants which provide food and cover for nesting birds and their young. Nesting structures for Canada geese may then be placed either on the shoreline or in shallow water.

### ***Integrating Farm and Ranch Practices***

Farm and ranch activities such as livestock grazing and irrigation can be incorporated with a wetland management plan to enhance wildlife if applied judiciously. Grazing to promote vegetation vigor and draining excess water for irrigation should be carefully timed to provide benefits to both wildlife and agriculture.

Livestock should not be permitted to overgraze wetland fringes and adjacent uplands where waterfowl and other wildlife nest, feed, rear broods, and seek protective cover. However, moderate grazing at a specific time of year at a proper stocking rate will prevent vegetation from becoming decadent and unproductive. Depending on the particular site, prescribed livestock grazing once every 3 to 5 years will enhance vegetation cover for wildlife. However, livestock operators should experiment with this recom-

mended interval to determine the optimum grazing management strategy for the specific site.

Late summer or fall grazing is recommended rather than early spring or summer to avoid disturbing nesting waterfowl and other wetland birds. Ideally, livestock grazing should be excluded from waterfowl nesting areas during the period of May 1 to June 30 each year to enhance nesting and brooding activities. Livestock should be removed when the vegetation cover shows signs of trampling or excessive use. In some situations, heavy livestock grazing on selected locations can enhance conditions for species such as Canada geese, who prefer grazing areas with unobstructed vision for security from predation or disturbance.

If financially feasible, the entire wetland complex should be fenced to regulate livestock grazing. A livestock watering gap can be strategically located to provide access to water, or offsite water could be developed by piping water to a trough. Fencing should be constructed into the permanent open water wetland zone to prevent livestock from walking around the water gap during low water periods and gaining access to the enclosed area.

Gates should be included at strategic locations along the fence to allow periodic proper grazing of the enclosed vegetation to maintain vegetation vigor and avoid vegetation stagnation and decadence. Haying within the enclosed area around the wetland can be detrimental to wildlife habitat, especially if forage is cut in late spring or early summer during nesting and brood rearing.

Water normally released for prescribed drawdowns can be used for irrigation purposes. Rapidly accumulating spring runoff, if used for irrigation purposes, must be released in a short time to prevent flooding ground cover within the outer temporary wetland zone. Accumulated water within the seasonal wetland zone can be released slowly over a longer period for irrigation benefits. Water in the semipermanent and permanent wetland zones can be used for irrigation in those years when full drawdown is implemented for aquatic plant regeneration and outlet maintenance.



## Questions for Chapter 11

1. Describe how agriculture, commercial, and urban development have affected the quantity and quality of wetlands found in Kansas.
2. What three factors should be considered when formulating a wetland management plan?
3. What is moist soil management? Why is it so successful in attracting wintering waterfowl?
4. Describe how moist soil management units are operated.



## Chapter 12

# Waterfowl Management

Ronald D. Pritchert and Robert M. Morton  
with modification by KDWP

Kansas provides breeding, migratory, and/or wintering habitat for about 19 different North American waterfowl species which can be commonly found in the state at some period during the year (Table 1). Several other species are not common and are observed during some years only, depending on available wetlands and weather conditions.

Most waterfowl species are migratory and spend only a portion of the year in Kansas. Duck concentrations are generally highest during late November and December when fall migration peaks (Figure 1). The greatest number of species is found throughout Kansas during late February through early March (spring migration).

Categorized by region, duck migration routes (**flyways**) are well-known. There are four major flyways on the continent (Figure 2). The Atlantic Flyway is associated with the Atlantic Coast. The Central Flyway comprises the Mississippi River region and associated rivers. The Central Flyway consists primarily of the Plains states (Kansas is in the Mississippi Flyway). The Pacific Flyway includes the region from the Rocky Mountains west to the Pacific Coast.

Some of the largest duck and goose migration corridors in the nation cross the borders of Kansas. The greatest concentrations of ducks historically occurred in the central part of the state, where natural marsh type habitat was and remains most common. However, in recent years, marshes developed and managed by man along with the numerous reservoirs constructed since the 1950s have resulted in more widespread distribution of ducks in Kansas, with the eastern third of the state having larger migration and wintering numbers during some years. The largest number of geese migrate along the eastern edge of the state. These birds are composed primarily of mid-continent snow geese, the largest population of geese in North America. Another corridor extends through the central portion of Kansas, similar to that of the ducks. This corridor is used primarily by Canada and white-fronted geese.

The three most common waterfowl species which nest and produce young in Kansas are the wood duck, mallard, and blue-winged teal. Canada geese are increasing in number and may eventually surpass some of the duck species in breeding numbers. The prairie pothole and parkland regions of the north-central United States and Canada are the primary breeding grounds for North American waterfowl (Figure 3). The most important breeding area

**Table 1. Waterfowl species commonly seen on Kansas wetlands and the period of peak abundance.**

Species	Period of Peak Abundance
<i>Dabbling Ducks</i>	
Mallard	Dec. – Jan.
Wood Duck	Sept. – Nov.
Black Duck	Dec. – Jan.
Gadwall	Oct. – Dec.
Green-winged Teal	Oct. – Dec.
Blue-winged Teal	Sept.
Northern Pintail	Oct. – Dec.
American Widgeon	Oct. – Dec.
Northern Shoveler	Oct. – Dec.
<i>Diving Ducks</i>	
Lesser Scaup	Nov. – Jan.
Greater Scaup	Nov. – Jan.
Ring-necked Duck	Nov. – Jan.
Canvasback	Nov. – Jan.
Redhead	Nov. – Jan.
Goldeneye	Nov. – Feb.
Bufflehead	Nov. – Feb.
Hooded Merganser	Nov. – Feb.
Red-breasted Merganser	Nov. – Jan.
Ruddy Duck	Dec. – March

for ducks is the prairie pothole region. In an average year, about 50 percent of this country's ducks are produced on less than 10 percent of the available breeding area. Other areas which provide substantial amounts of breeding habitat include eastern Canada, the northern latitudes of the midwestern U.S., central Alaska, and northern California.

## Natural History

### Ducks

Ducks, geese, and swans are all members of the same family (*Anatidae*) which is characterized by large bills, webbed feet, rounded bodies, and long necks. Other duck traits include brightly colored males and drab females, two body molts (loss and replacement of feathers) a year, elaborate courtship displays, and brief annual pair bonds, although only the female incubates eggs and cares for the young.

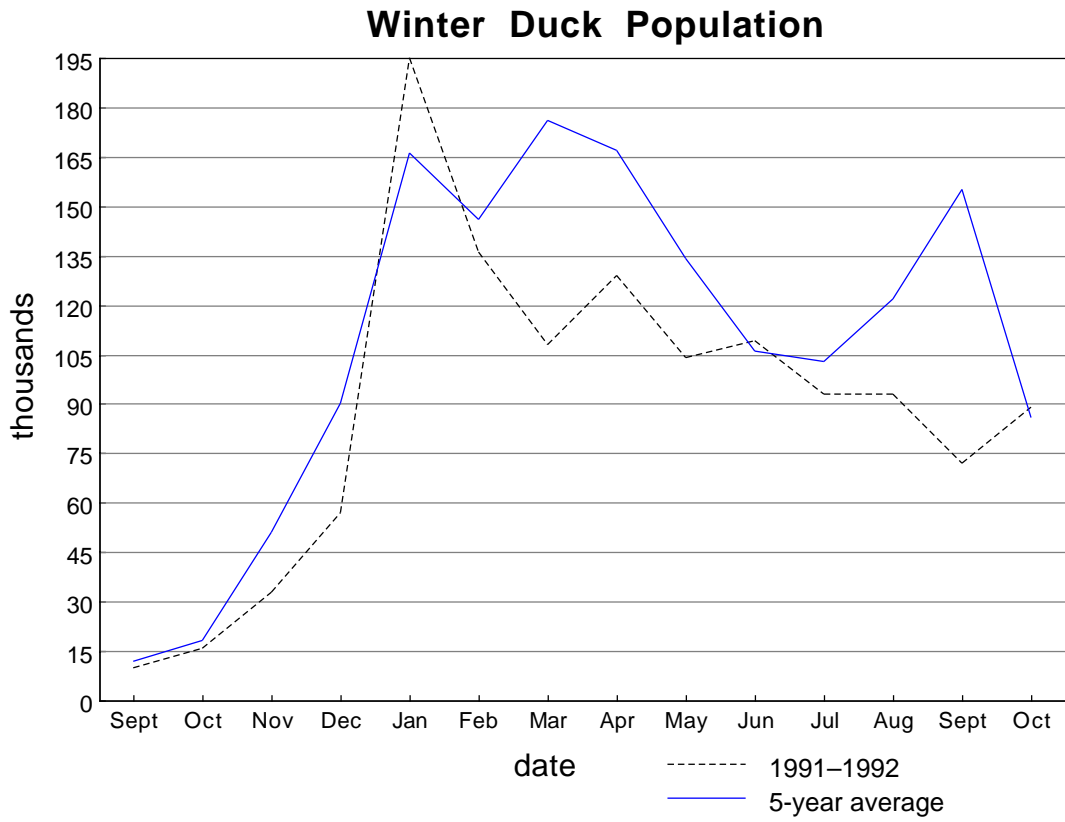

Figure 1. Chronology of winter duck population peaks in Kansas.

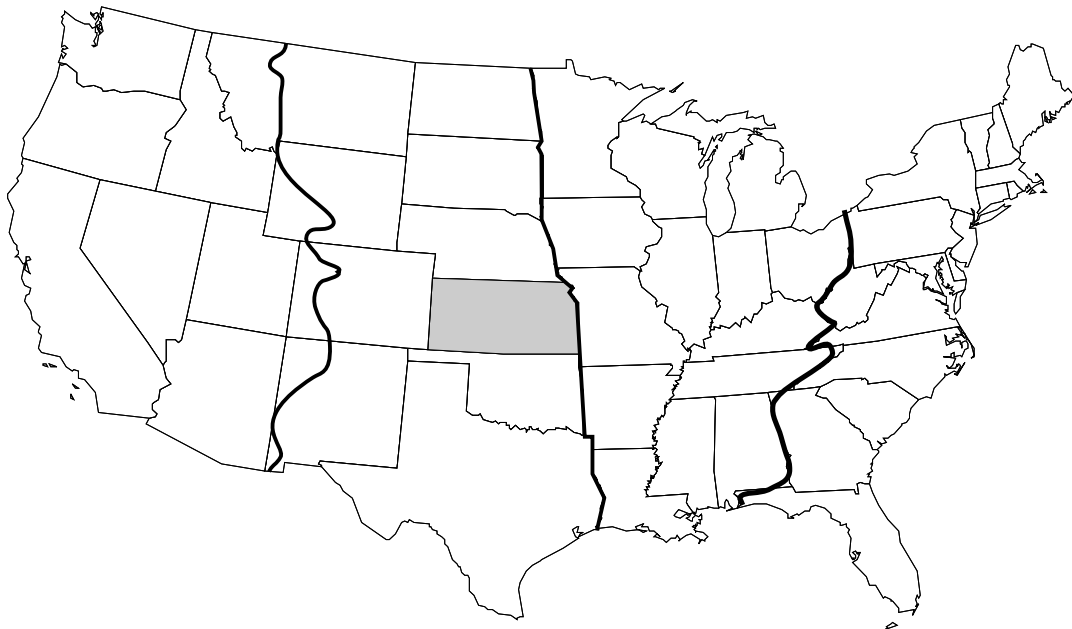

Figure 2. The administrative waterfowl flyway units. Kansas is in the Central Flyway.

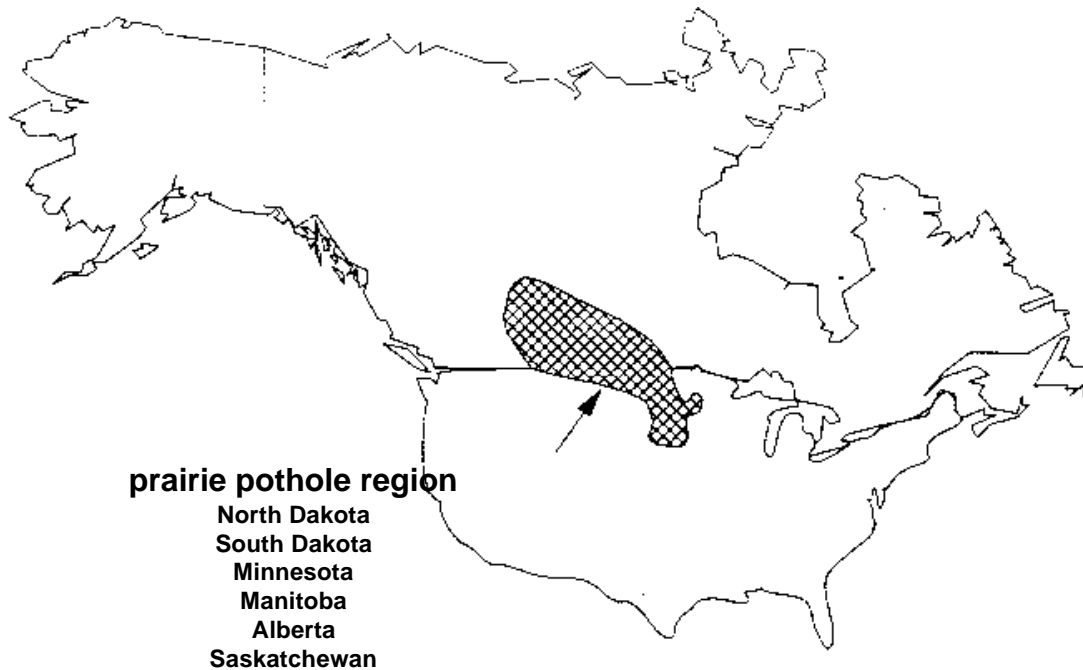

Figure 3. Primary breeding grounds for North American waterfowl.

North American ducks are separated into five groups. These groups are commonly lumped together into one of three general categories (diving, dabbling, or perching ducks).

The diving duck group (**divers**) are actually three groups placed together because they have similar feeding habits. This group prefers open, deep-water habitats with plenty of **submergent plants** (plants rooted in the bottom and growing under the water) and/or aquatic invertebrates. A distinguishing characteristic of divers is that they run along the water to gain flight.

Six species of diving ducks and two species of mergansers commonly occur in Kansas. Among the diving ducks, ring-necked ducks, scaup, goldeneye, and bufflehead are the most common. Common mergansers are one of the most abundant wintering waterfowl in Kansas, with as many as 50,000 being reported. These fish-eating birds utilize the reservoirs extensively and remain in the state until extremely cold, frozen conditions move them further south.

The other two groups of ducks are the **dabbling** (puddle) and **perching** (tree) ducks. Both of these duck groups have similar habits. Dabbling and perching ducks have brightly colored wing patches, are usually seen feeding by a “tipping up” motion, and spring into flight. The four most common dabbling ducks seen in Kansas during migration and winter periods are the mallard, green-winged teal, pintail, and gadwall. These species are most commonly seen on marshes and the shallow perimeter of ponds, lakes, and reservoirs. Other common dabbling ducks include widgeon, blue-winged teal, northern shoveler, and the wood

duck. The two species of teal along with the northern shoveler and pintail are among the earliest migrating ducks to move into Kansas. Of these, the green-winged teal is the smallest North American duck and also one of the heartiest, often staying until frozen water conditions force it to move south. Often, mixed flocks of dabblers are observed resting together. The species can live in the same habitats because they have different feeding patterns. Mallards and pintails frequently feed on agricultural grains and native foods. Other species such as gadwall, widgeon, shovelers, and blue-winged teal prefer seeds, vegetative parts, and invertebrates associated with wetland flora. Thus, there is little competition between dabbling duck species.

The wood duck is the only perching duck native to Kansas. Because this duck produces a large number of young in Kansas, the life history and management of wood ducks are discussed in a separate chapter.

### Geese

To many people, geese are truly a symbol of the northern wilderness, representing the mystery of our natural environment. The sight of “V-shaped” flocks and the sound of distant honks each fall may lead a person to ponder over the travels of these annual visitors. How geese move from the vast, featureless arctic tundra breeding grounds to southern wintering areas in the United States and Mexico remains a mystery.

There are six distinct species (Ross’s goose, emperor goose, white-fronted goose, snow goose, brant, and Canada

goose) native to North America. Five of the six species can be found in more than one continent. The Canada goose is the only species native just to North America. The emperor goose is the only species that does not winter in the contiguous United States.

Three of the six goose species are commonly seen in Kansas during the winter. Mid-continent snow geese are most common in the eastern one-third of the state, they tend to occur in large flocks, with concentrations as high as 250,000 reported from the northeast counties of Kansas. The migration and wintering range of snow geese in Kansas seems to be extending westward, with these white geese being regularly reported in the central, and occasionally western, areas of the state.

White-fronted geese occur statewide with the largest concentrations occurring in the central and western portions of Kansas where shallow, marsh-type habitat is more common. Until the past decade, most Canada geese observed in Kansas were migrants moving through or wintering in our state. Since about 1980, Canada geese have been introduced into most counties and have prospered. Canada geese may be seen border to border, and with their widespread distribution, are the geese most commonly observed by Kansas residents.

To date, man's impact on most goose populations has been relatively minor compared to his effect on duck populations. Much of the breeding range for geese lies in tundra or sub-tundra areas. These areas are not easily farmed or logged. However, the intrusion of man may not be far off. Our dependence on fossil fuels may necessitate oil exploration in these fragile habitats. If we cannot limit the destructive nature of these activities, North American goose populations may suffer in ways similar to duck populations.

Geese are close relatives to ducks; however, there are several differences in the two groups. First, male and female geese look similar to one another. Second, geese mate for life. However, if a mate is lost, the survivor will usually remate before the next breeding season. Third, both parents care for the young compared to ducks where the hen is the only adult caring for young. Goose families remain intact until the following nesting season.

Goose families are important in flock social order. Dominance is as follows: large families > smaller families > pairs > singles. Older geese are more successful nesters than younger birds, and geese do not breed until they are at least 2 years of age.

The life-span of geese is relatively long compared to ducks. Most duck and goose mortality occurs during the bird's first year. Annual survival rates increase substantially for older geese. Reports of wild Canada geese older than 20 years of age are not uncommon.

Geese also use traditional breeding and wintering areas. It is not unusual for a family of geese to use the same

breeding, staging, and wintering areas year after year. Yearling birds learn these areas from experience by following their parents. Today, most goose management is targeted for specific populations that use those traditional areas.

### ***Waterfowl Management***

Management of North America's waterfowl resource requires the cooperation of several countries because waterfowl do not recognize the arbitrary boundaries drawn by man. The migratory travels of waterfowl may carry them across the boundaries of two or more nations each year. Most North American ducks and geese winter in the United States and Mexico but breed, raise young, and molt on Canadian wetlands.

International cooperation is critical for duck and goose management. The Migratory Bird Treaty Act of 1918 implemented an agreement between Great Britain (for Canada) and the United States for the protection of migratory birds. This treaty established federal jurisdiction for protecting the international migratory bird resource. The act was amended in 1936 and 1974 to include Mexico and Japan, respectively. In 1978 a treaty similar to the Migratory Bird Treaty Act was signed with the Union of Soviet Socialist Republics giving international protection to waterfowl with circumpolar distributions.

Within North America, differences in supply and demand of the waterfowl resource have resulted in managing waterfowl on the flyway management concept. There are four flyway councils, and each council's management decisions are based on the historic migratory patterns of the birds. Each council (Atlantic, Mississippi, Central, and Pacific) is composed of the states and Canadian provinces associated with their respective migratory region. This format allows the council to address the interests and concerns of each state or province. Each council has a technical section which is made up of the waterfowl specialists from each state and province. Flyway councils meet in the spring and late summer each year to vote on the management recommendations of the technical section. Annual recommendations for harvest regulations are made at the summer meeting. The U.S. Fish and Wildlife Service gives final approval for regulation recommendations.

Management activities can be categorized under three general topics: habitat preservation and/or enhancement, harvest regulations, and disease control. Of the three, habitat preservation and/or enhancement is the most important. Without sufficient breeding, migratory, and wintering habitats, there would be little need for waterfowl harvest regulations.

### **Habitat Preservation and Enhancement**

Waterfowl populations are in serious trouble in this country. A number of factors, including habitat destruction,



chemical contamination of existing wetland habitat, and a series of droughts in the prairie pothole region have caused duck populations in North America to drop to 62 million birds in 1992. The federal government and the KDWP have been doing mid-winter waterfowl surveys since 1955 to count the number of ducks in this country.

The number of ducks seen in Kansas during these surveys has declined from a high of 1,015,800 reported in 1978 to 96,946 in 1993, a decline of 90 percent.

The KDWP conducts two waterfowl counts per month on public lands from September through March (14 counts total). There is about an 88 percent decrease in the average count from these public areas between 1971 and 1991 (Figure 4).

These recent declines in waterfowl populations have raised many questions concerning the status of waterfowl habitat in North America. The most critical problem facing North American waterfowl populations today is the loss of wetland habitat. Nearly 500,000 acres of wetlands are lost annually to agriculture and urban or industrial development. Wetlands, potholes in the northern prairie region, coastal marshes, bogs, fens, and bottomland hardwood swamps are essential for breeding, migrating, and wintering waterfowl. More than 50 percent of North America's wetland resources have been lost and in some regions (the Central Valley of California) as much as 80 percent.

In addition, associated upland grass nesting sites, critical to mallards and pintails, are being lost at a rate of 2 percent a year. Only 12 percent of Canada's original natural grasslands (one of the primary waterfowl nesting areas) remain. In the last ten years, 33 percent of the remaining grasslands in the north-central states have been converted into cropland.

The problem of suitable habitat is made worse by intensive agriculture which results in other environmental problems. Soil erosion, water quality degradation, siltation, and chemical contamination results in poorer quality wetland habitat. Poor soil management and wetland drainage can result in salinization, thereby lowering the land's productivity for both agriculture and wildlife.

The long-term destruction of wetland habitats may have severely affected the ability of ducks to survive. Although wetlands are lost by both natural and man-made disturbances, the activities of man are ultimately responsible for much of the habitat destruction (see Chapters 10 and 11 for a discussion of wetland losses). Approximately 56 percent of wetlands in the states have already been lost and is estimated that the Nation will lose an additional 4,250,000 acres of wetlands by the year 2000. At no time have the effects of wetland losses been felt more than when coupled with the current drought in the prairies.

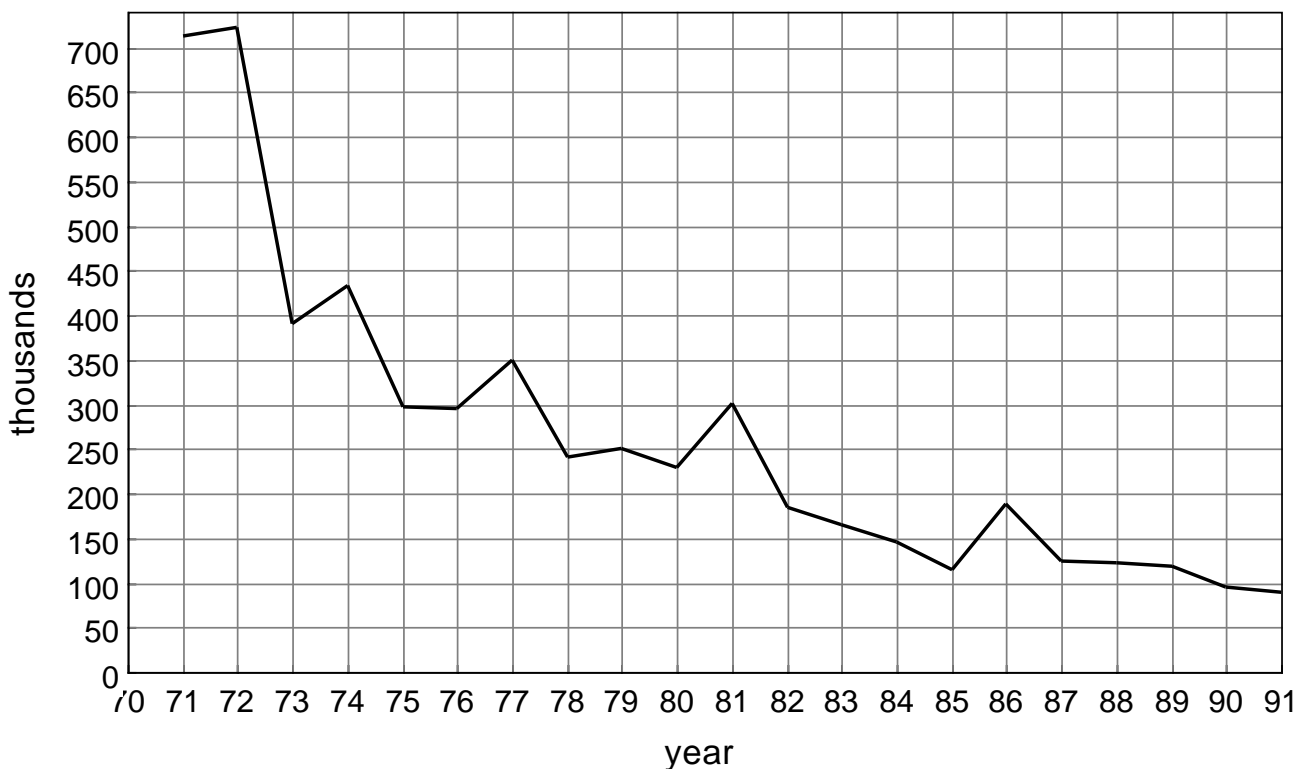

Figure 4. Average number of ducks seen in Kansas during waterfowl surveys 1971–91.

Ducks have adapted well to the wet and dry cyclic occurrences characteristic of the prairie breeding grounds. Mobility, long life-span, large clutch sizes, and the ability to reneest are excellent adaptations for prairie nesting duck species. Greater mobility of waterfowl permits breeding ducks to seek wetlands suitable for nesting. In wet years, when wetlands are abundant, the ducks respond and have a banner production year. However, in years of drought, when the number of wetlands are reduced, few birds try to reproduce, and predators can find the birds and their nests more easily because they are more concentrated. Most continue to fly farther north to more permanent wetlands.

Reproduction is limited on these alternate wetlands because most are relatively sterile and unable to meet the energy needs of the birds for reproduction. Although alternate wetlands provide little for reproduction, they do increase over-summer survival of the species. This helps ensure that breeding individuals are present in the population when favorable nesting conditions return to the prairies.

Unabated wetland losses during the last 15 years may limit duck population increases usually associated with wet years. Vast amounts of wetland acreage have been permanently lost during the recent drought. Some regions of prairie Canada have lost as much as 40 percent of the wetlands available before the drought. How well duck populations will be able to recover from the recent drought remains to be seen.

What is being done to combat this continuing decline in waterfowl populations? Biologists from the U.S. Fish and Wildlife Service and the Canadian Wildlife Service have taken seven years to outline a plan of action to preserve North America's magnificent waterfowl populations.

On May 14, 1986, Secretary of the Interior Donald P. Hodel and Canadian Environment Minister Thomas McMillan signed a historic agreement to assure the continued survival of ducks, geese, and swans in North America. That far-reaching document, the North American Waterfowl Management Plan (NAWMP), sets a course of action for both countries to follow from now until the year 2000. If everyone who cares about waterfowl pitches in, this plan could become a modern conservation success story similar to the restoration of wild turkey, pronghorn antelope, and whooping cranes.

### **North American Waterfowl Management Plan**

The North American Waterfowl Management Plan (NAWMP) is an international cooperative effort providing a broad framework for waterfowl management and conservation in the U.S. and Canada. The plan's overall goal is to ensure that sufficient habitat exists to support 62 million breeding ducks, 6 million overwintering geese, a wintering population of 152,600 swans, and a fall flight of more than 100 million birds. This goal was based on how much habitat existed in the 1970s. The plan also:

- *identifies habitat conservation needs in specific regions of the continent,*
- *recommends measures for solving problems of international concern,*
- *outlines the scope of work to be accomplished by cooperating agencies, and*
- *provides broad guidelines for habitat protection and management.*

Since preserving suitable habitat for breeding and wintering waterfowl is critical, the emphasis of the NAWMP is acquisition. However, this program cannot be based solely on fee acquisition. It must be compatible with agricultural and industrial uses. Land acquisition is also beyond the capabilities of public resource agencies alone, so implementation requires cooperation with governments, private organizations, sportsmen, non-hunters, landowners, and concerned citizens.

The plan's overall habitat conservation goals (spanning 15 years from 1986 to 2000) are to:

- 1) *restore mallard and pintail breeding habitat in the midcontinent to the levels of the 1970s by protecting and improving 1.1 million acres of waterfowl habitat at a ratio of 3:1 (upland nesting cover: acre water) in the U.S., and 3.6 million acres of waterfowl habitat in Canada;*
- 2) *protect 686,000 acres of mallard and pintail migration and wintering habitat in the lower Mississippi River-Gulf Coast region;*
- 3) *protect and restore 80,000 acres of pintail wintering habitat in California's Central Valley;*
- 4) *protect 60,000 acres of black duck breeding and migration habitat in the Great Lakes-St. Lawrence lowlands in Canada and 10,000 acres in the U.S.;*
- 5) *protect and enhance 50,000 acres of black duck migration and wintering habitat on the U.S. East Coast and 10,000 acres on Canada's East Coast; and*
- 6) *increase the carrying capacity of habitat already acquired for migratory waterfowl, maintain habitat value of 34 designated waterfowl regions in North America, and minimize exposure to pollutants in waterfowl habitats of acceptable quality.*

This broad policy framework does not give site-specific details necessary for individual projects. However, the plan identifies critically important waterfowl regions including the prairie pothole region in central Canada and the U.S., the Great Lakes-St. Lawrence lowlands, the Atlantic Coast, California's Central Valley, the lower Mississippi Valley bottomlands, the Gulf Coast, and the Playa Lakes Joint Venture. The projects, called joint ventures, define the NAWMP's goals within that region. For example, Kansas is participating in the Playa Lakes Joint Venture, a strategy for implementing these goals within a ten-state area (Figure 5).

## Goals and Objectives of Playa Lakes Joint Venture

Areas dedicated to waterfowl management must provide a variety of habitats and nutrients required for molting, migration, and reproduction. For example, high energy (carbohydrate) food provided by agricultural crops is required in winter. In the spring, birds need a variety of nutrients (to migrate and reproduce) provided by invertebrates and native plants found in flooded bottomland forests and other natural wetlands.

Public areas in Kansas where waterfowl management is the primary objective are Cheyenne Bottoms, Quivira NWR, Kirwin NWR, Flint Hills NWR, Jamestown Wildlife Area, Texas Lake Wildlife Area, and the Slate Creek Wildlife Area (Figure 6). Areas managed for waterfowl in Kansas focus on meeting the needs of migrating and wintering birds. Management on state areas tries to supplement the habitat component (food, water, cover) that may be lacking. In many instances, private wetlands and agricultural lands supply some foods and resting habitat when hunting seasons are closed. During the open hunting season, state lands may provide the only resting habitat and sanctuary (two essential components for maintaining waterfowl use in the area) for waterfowl.

Management practices vary for ducks and geese. Ducks are more wetland-oriented and prefer a little more water with their food. Flooded moist soil impoundments, supple-

mented with flooded crop fields, are attractive to most dabbling species. Water should remain on areas through the winter with a slow drawdown during spring migration. Spring migrating ducks feed on the abundant invertebrates found in the wetlands at that time.

Geese are more upland-oriented than ducks. However, it is not unusual to see geese tipping up to feed in wetlands right alongside many species of ducks. Many of the wetlands used by geese provide safe resting habitats. Areas managed specifically for geese should provide a large body of water as sanctuary for roosting, resting, and bathing. Managing for geese devotes proportionately more land to producing agricultural crops for food. Corn and forage crops, such as winter wheat and clover, are important winter foods for geese.

## Harvest Regulations

The purpose of hunting regulations is to control the harvest of waterfowl. This is accomplished by limiting the harvest to the surplus of each species. Surplus means that portion of the population in excess of the breeding component necessary to maintain the population at a certain level or objective. Surpluses are based on quantity and quality of breeding habitat and the annual compensatory mortality (see Chapter 5). Compensatory mortality varies by species population size and is strongly influenced by habitat conditions.

Determining the surplus is not an easy task. It requires the cooperative efforts of federal, provincial (Canadian), and state waterfowl biologists to collect important information. The size of the breeding population, age and sex ratios, survival rates, and habitat conditions must be known to accurately determine the annual surplus. Age and sex ratios along with survival rates are estimated from the data collected during the previous hunting season. Estimates of breeding populations, reproductive success, and habitat conditions are obtained from surveys conducted during the current nesting year. All the above are factored together to make a fall flight forecast.

The fall flight forecast is an estimate of the total number of ducks available after reproduction and before hunting season. Hunting season length, bag limits, and species restrictions are set from this information. Methods of determining hunting regulations for geese are similar except population estimates of breeding are obtained from a nationwide coordinated December survey.

Harvest regulations differ somewhat for ducks and geese. Season length and bag limits for ducks are fairly uniform across the four flyways. The breeding range for most of the continental duck population occurs within the north-central prairies of the U.S. and central prairies and prairie parklands of Canada. Thus, any declines or increases in productivity of ducks nesting in this region are experi-

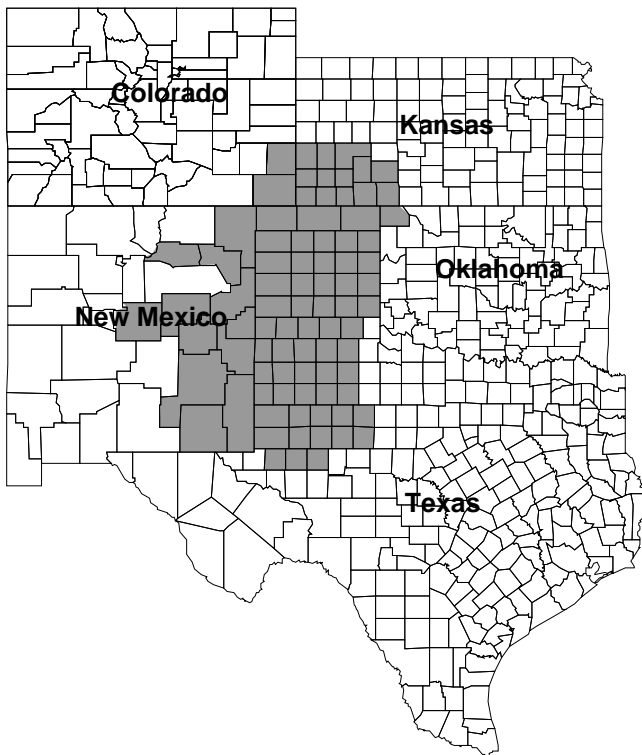

Figure 5. Location of the Playa Lake Joint Venture.

enced by all the flyways. Harvesting ducks in excess of the surplus in any of the flyways may negatively impact the entire population.

Unlike ducks, geese nest from Oklahoma and Kansas north to the arctic and subarctic tundra. Populations using specific breeding ranges are closely associated with certain wintering areas. Maintenance of the family bond during the first year allows juveniles the opportunity to imprint on these wintering areas. Except for flyways with shared populations, there is little relation between the reproductive success and harvest of one population versus that of another. Therefore, goose management in some regions can be tailored for specific populations without affecting other goose populations.

**Disease Control**

Current practical knowledge for waterfowl disease control is limited. The number of waterfowl that die each year from disease is unknown. Many times, predators and scavengers remove the bird before it is noticed by man. Other sick birds seek isolation and shelter and die unnoticed. Only when a major die-off occurs are managers able to respond to the individual situation. Most management efforts are concentrated on dispersing birds and disposing of carcasses whenever a large outbreak occurs.

Contaminant poisoning (lead poisoning) is another factor frequently associated with disease. Contaminant

poisoning is something managers may have more control over. Lead poisoning in waterfowl has long been recognized as a major cause of death in some areas. The impact of lead poisoning on reproduction is still unknown. The use of lead shot for hunting waterfowl and other marsh-oriented game birds became illegal nation-wide in 1991-92. However, lead poisoning will continue until the lead shot deposited during the previous decades of hunting becomes unavailable to feeding birds. Selenium and other contaminants are non-point pollutants that present problems in certain areas. Future efforts may need to focus on reducing non-point pollution to eliminate this danger to waterfowl and man.

**Summary**

Concern over recent declines in waterfowl populations and continued habitat losses have resulted in a landmark agreement between the U.S., Canada, and Mexico. The North American Waterfowl Management Plan outlines specific population and habitat goals in order to achieve an annual fall flight of 100 million ducks and 6 million geese by the year 2000. This is a tremendous undertaking which requires cooperation on an international scale never before reached. Federal, state, and private organizations from many different backgrounds are deeply involved. The outcome of the NAWMP may very well determine the future status of waterfowl populations in North America.

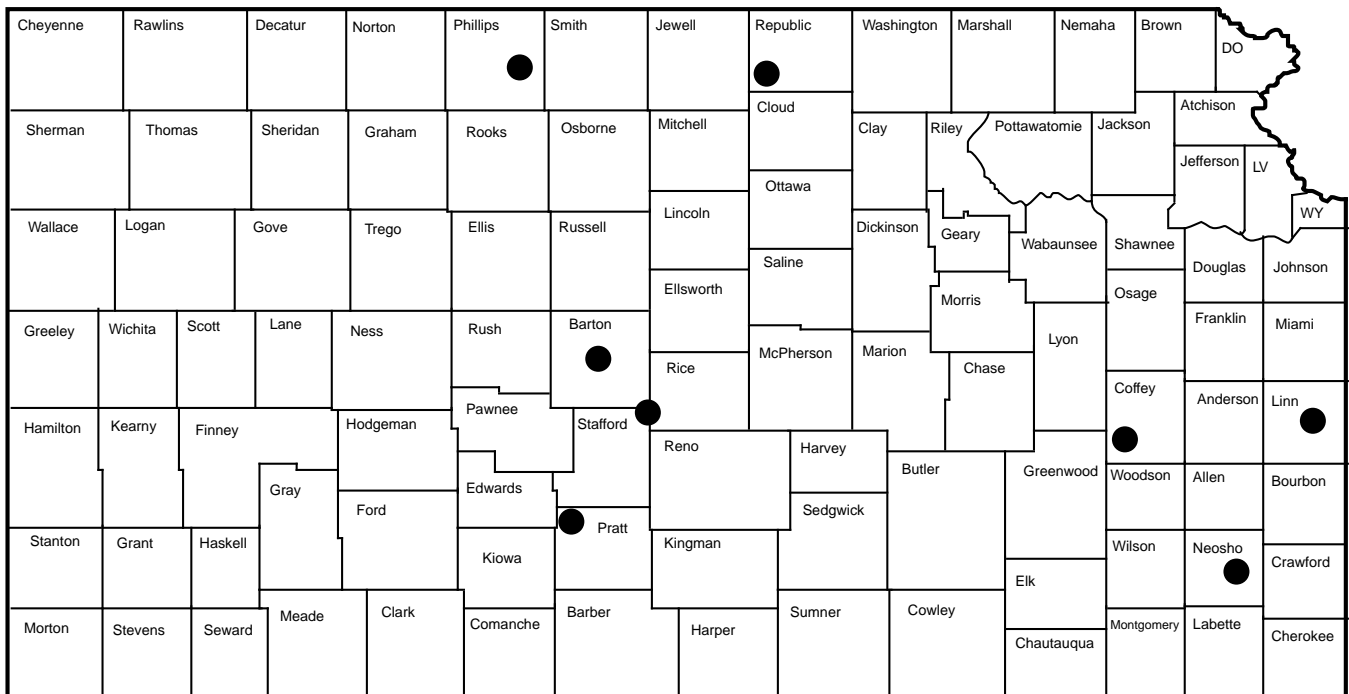

Figure 6. Distribution of public areas in Kansas where waterfowl management is a primary objective.





## Questions for Chapter 12

1. Duck migration routes are known as flyways. What are the four North American flyways? Kansas is in which flyway? What are migration corridors? How many migration corridors bisect Kansas?
2. What is the most important waterfowl breeding ground for North American waterfowl? In an average year what percentage of ducks are produced in this region?
3. What types of habitat do diving ducks prefer? dabbling ducks? perching ducks? List the duck species that are found in each group.
4. Ducks, geese, and swans belong to the same family of birds. There are some differences between ducks and geese. In general, how does the life-history strategy of ducks and geese differ?
5. Why is international cooperation necessary for duck and goose management? How is this accomplished?





## Chapter 13

## Wood Duck

*Robert D. Smith and Ronald D. Pritchert*



The wood duck or “woodie” is a symbol of forested wetlands to hunters, bird watchers, photographers, and artists. This bird is one of the most beautiful water birds in the world. It can be found in 42 states and five Canadian provinces. The wood duck is commonly found visiting sloughs, ponds, and streams. This was not the case at the turn of the century, and the recovery of wood duck populations is a classic conservation story.

In the early part of the 1900s, its numbers were so low that many people feared the wood duck would become extinct. The birds were losing habitat throughout their range. The passage of the Migratory Bird Treaty Act of 1918 provided the necessary protection to save the birds from possible extinction.

Restricted hunting from 1918 through 1941 throughout this country and the concerted research and management efforts of waterfowl biologists and managers helped to reestablish woodies across all of their historic range. Habitat preservation, management, research developing nesting box designs, and regulated hunting have been part of the conservation success story. As a result of these efforts, wood ducks today are among the most common nesting duck species in Kansas.

### *What Makes a Wood Duck a Wood Duck*

Wood ducks may be the most attractive and brightly colored ducks in North America. Male woodies have a large purple and green crested head. The eyes and base of the bill are bright red. The birds also have a pair of white parallel lines running from the bill and back of the eye to the rear of the crest. Male wood ducks have a burgundy-colored chest with white fleckings and a white breast and belly. The purplish-black back sharply contrasts with the breast and belly. Not only is the male wood duck the most attractive of our waterfowl, the female is also more colorful than other female ducks. Female woodies are gray-brown with a distinct white, tear-dropped-shaped eye ring. Young females may not show this coloration around the eye. They have a sooty-gray crested head. Both sexes have short wings (8 to 9 inches in length) with iridescent purple wing patches. Adult wood ducks weigh about 1 pound and measure about 20 inches long.

### *Cover, Food, Water, and Space Needs*

There are three distinct wood duck populations (Atlantic, Interior, and Pacific) in North America. Kansas birds belong in the Interior population. Wood duck populations are larger in the eastern half of Kansas although substantial numbers of birds are also seen along stream corridors in the western parts of the state. Fall migration usually occurs in September and October, whereas spring migration peaks in February.

Typical wood duck habitat, found in bottomland hardwood swamps, wooded sloughs and marshes, or forested riparian areas, usually has an abundance of flooded timber. Ideal woodie habitat in Kansas includes bottomland forests with shrubs and herbaceous plants associated with water bodies that have long shorelines. Bottomland forests (either flooded or in close proximity to water) are used by wood ducks all year but are very important nesting cover.

Water should be available to the birds three to four weeks before nesting. Mature and overmature trees in these forests are an important habitat component because wood ducks nest in natural tree cavities. Silver maple, sycamore, ash, and cottonwood provide cavities in lowland areas. In drier areas, oaks and hackberry are important cavity-producing trees. Another part of good wood duck-breeding habitat is an abundance of loafing sites. Examples of

loafing sites include logs, stumps, muskrat mounds, beaver lodges, or islands in open water and shorelines.

Wood ducks also require security cover. This type of cover is used for brood habitat and escape cover for young molting ducks. Scrub/shrub habitats, where strong durable shrub stems rise about 2 feet above the water and spread into a thick overhanging canopy, are used during the late spring, summer, and early fall. Optimal brood-rearing habitat should be at least 5 acres. Ideal brood habitat consists of 30 to 40 percent shrubs, 35 to 70 percent wetland plants growing in water, 5 to 10 percent trees, and 25 percent open water.

The depth of the open water is also important. Shallow water is important in wood-duck habitat because the birds normally do not feed in water that is more than 18 inches

**Table 1. Plants important to wood ducks in Kansas.**

Arrowhead	Coontail	Sedges
Ash	Duckweed	Smartweed
Burreed	Hickories	Water elm
Buttercup	Lotus	Water lily
Buttonbush	Oaks	Wild rice
Chufa	Pondweed	

deep (Table 1). Plants growing in the shallow water (emergents) are an important food source for growing ducks because they harbor vast numbers of insects and other small animal life which are an important source of protein. Important emergent plants in the open and shrubby water habitats include cattails, water lily, smartweeds, water primrose, pickerel weed, rushes, reed canary grass, duckweeds, and sedges.

Flooded lowland forests with abundant mast trees are especially important winter feeding habitat. Oaks provide high energy food for the ducks. Seeds from buttonbush and various emergent plants are also important food items.

Other habitats, such as flooded dead timber, open marsh, lakes, and reservoirs, are used only after preferred habitats are unavailable. Large open areas (lakes or reservoirs) provide little food or cover for wood ducks.

## Reproduction

The wood duck is the most common waterfowl species nesting in Kansas. It is a tree duck and prefers to nest in hollow tree cavities. If hollow tree cavities are not available, the birds will nest in artificial cavities (nest boxes). Either cavity should be close to water.

Wood ducks begin to pair with one another starting in mid-October. By February most of the birds have paired off and begin the business of searching for a nest site. Yearling hens will pair and nest their first year. The birds will remain together through most of incubation unless it is a late nesting or renesting attempt in which case the male will

abandon the hen for molting.

Both the male and female search for and select a nesting cavity in March and April. Most nesting sites are close to water, but some may be up to one mile away. Wood duck hens have a remarkable tendency to return to the same breeding area year after year. Once a nest site has been selected, the female begins nesting activities. She makes a nest with materials in the cavity, adding down from her breast about the time the seventh egg is laid.

Hen wood ducks lay one egg a day for 10 to 15 days. Thus, an average nest size is 10 to 15 eggs; however, predation and dump nesting (when several hens lay eggs in the same nest cavity) make it difficult to accurately determine average nest size in the wild. In searching for a nest site, females sometimes lay eggs in several different nests. Dump nests containing 40 or more eggs have been reported.

The hen then sits on and incubates the eggs for 28 to 37 days after the last egg has been laid. The hen stays in the nest with the ducklings for about 24 hours allowing the young birds to dry thoroughly. When the ducklings are dry, the hen calls her brood from the nest and heads for water. The young birds climb out of the nest and jump to the water or the ground, sometimes from staggering heights. The female cares for the young by herself and takes the young birds to brood-rearing habitat.

The first few days and weeks after hatching are a difficult time for the young birds. Travel overland is hazardous if the nest is located away from water, and many young birds die en route. Only about 50 percent of ducklings will live to reach flying age.

The young ducks mature quickly. Ducklings remain covered with down for two to three weeks. By 6 weeks of age, the ducks are fully feathered and can fly between 8 to 10 weeks of age. At this time the adult females and their young separate. The females molt their old feathers at this time and grow new ones. The birds are flightless for about three weeks while flight feathers are being replaced. By this time the males have already molted. Most woodies are able to fly by late July to mid-August. By mid-October the drakes will once again be wearing their bright colorful plumage, and the annual cycle begins again.

## Wood Duck Nest Boxes

Certain practices have reduced suitable nesting sites for wood ducks. Removal of trees with nest cavities, drainage and destruction of wetlands, clearing timber stands for agriculture, and timber harvesting without leaving den trees have resulted in reduced nesting sites. Wood ducks will use artificial nest structures, which are probably the most recognized tool used for wood duck management. The first nest boxes were built and installed by the U.S. Biological Survey (now the U.S. Fish and Wildlife Service) on Chautauqua National Wildlife Refuge in central Illinois during 1937. Since then, thousands of nest boxes have been erected by federal and state agencies

as well as private landowners throughout the wood duck's range.

Through years of research examining wood duck preference for nesting boxes, and the following nesting success, biologists have concluded the best boxes are built from seasoned hardwoods such as cypress or hemlock. A wire screen should be attached to the inside of the box up to the entrance hole to allow traction for the day-old ducklings. All boxes must have 3 to 4 inches of wood chips added because the female does not bring nesting material to the cavity. The boxes should be checked each year, and this material should be changed, if needed. The nest boxes should be placed in small groups of two to four per acre, over water if possible. If the box cannot be placed over water, it should be close to a permanent water source.

The first boxes were built of wood and required frequent replacement. In an effort to reduce maintenance and replacement costs and predation, nest boxes were built of a

variety of materials including plastic, fiberglass, and metal. These boxes should not be used because they result in elevated temperatures inside the box that kill the duck embryos.

Predators are another factor that limit wood duck production. It does little good to put up nest boxes if the result is setting the table with an easy meal for predators. Unfortunately, as woodies adapted to using nest boxes, their predators learned to associate nest boxes with a potential meal. Raccoons, rat snakes, fox squirrels, and starlings commonly destroy wood duck nests.

Research has shown that the raccoon is a major predator of wood duck nests. Thus, predator guards should be installed whenever possible. Consideration can also be given to placing boxes in trees which predators cannot reach from another tree. The protection offered by nest boxes and predator guards should be equal to, if not better than, that of natural cavities.



*Shallow water wetlands, with overhead cover are very important wood-duck breeding habitat in.*



*Wood duck nest boxes should be built from seasoned hardwoods to specified dimensions and placed over water wherever possible. A predator guard should be placed under each nest box.*



## Questions for Chapter 13

1. What factors contributed to the decline and subsequent restoration of wood duck populations in North America?
2. What part of the state has the highest numbers of wood ducks? Describe a typical wood duck habitat in Kansas.
3. What types of foods do adult and immature wood ducks eat?
4. Why is shallow water an important component of wood duck habitat?

### Questions for Chapter 13 (continued)

5. If you are planning to build wood duck nest boxes, what material should the boxes be built of? What other special considerations are important when building a wood duck nest box? Where should wood duck nest boxes be placed?

6. Why should a predator guard be erected under each nest box?

Name \_\_\_\_\_

## Chapter 14

# Mallard

Ronald D. Pritchert and Robert M. Morton



Mallards are the most common duck species found in North America. The U.S. Fish and Wildlife Service estimated that during the 1992 fall migration flight, mallards accounted for 15 percent of the entire duck population. Mallards are the most widely distributed waterfowl species in the Northern Hemisphere. They can be found from the Arctic to the subtropics in Asia, Europe, and North America. The mallard is the most common migrating waterfowl species found in Kansas. Mallards usually compose about 50 percent of the Kansas duck harvest (Figure 1). Many varieties of domestic ducks have a mallard ancestry.

## What Makes a Mallard a Mallard

In breeding color, drake mallards are the most often recognized of all our waterfowl species. The iridescent green head, white neck ring, brown chest, gray sides, olive-colored bill, and dark rump allow for quick identification. As with most ducks, the hens are not very colorful. Hens are a light brown streaked with darker brown. This pattern is more apparent on the back than the belly. A characteristic dark eye stripe and mottled orange bill distinguish hen mallards from females of other duck species. Both sexes have bright orange legs and violet-blue wing patches, which are bordered by white bars on the leading and trailing edges. These wing patches are visible in flight. During the summer months, when the birds lose their breeding plumage, the sexes look similar. However, males can still be distinguished from females by their olive-colored bills.

## Cover, Food, Water, and Space Needs

In early April, the first mallards arriving on northern breeding areas begin their age-old nesting rituals. The number of birds quickly swells through April as breeding birds return. Mallards that breed in Alaska arrive on the breeding grounds last, usually during the first week of May.

The breeding range of mallards is the most extensive of any duck species on the continent. It encompasses the northern one-third of the United States northwestward to Alaska. There are areas of preference where breeding densities are greatest within this large breeding range. For example, it has been estimated that almost 54 percent of the continental mallard population breeds in the region of Alberta, Manitoba, and southern Saskatchewan. Other important areas include the “Prairie Pothole” region of North and South Dakota and western Minnesota. The pothole country is characterized by rapid changes in water abundance as almost one-half of the ponds present in spring have dried up by mid-summer. Thus, rapidly changing pond conditions greatly influence mallard breeding distributions.

Female mallards have a sense of homing when returning to the breeding grounds. Females that raised a successful nest the previous year and a proportion of first-year birds may return (**home**) to breed in areas where they were raised (**natal areas**). However, hens also play the major role in finding new breeding areas. Few drakes return to their natal areas because the birds form pair bonds on the wintering grounds, and drakes follow their mates back to the hen’s breeding site.

Most mallards breed during their first year, although many hens will not nest during drought conditions. Older females are usually more successful nesters because of their experience in establishing home ranges and selecting nest sites.

Mallards begin establishing pair bonds as early as mid-autumn and continue through winter. For example, in Louisiana it has been estimated that about 90 percent of the mallard hens are seen with an accompanying drake by January. Forming pair bonds early has some advantages. Birds that have formed early pair bonds exhibit dominance over other birds. In addition, pairs are able to invest more time feeding and less time defending preferred territories. Almost all hens are paired by the time birds return to the breeding grounds.

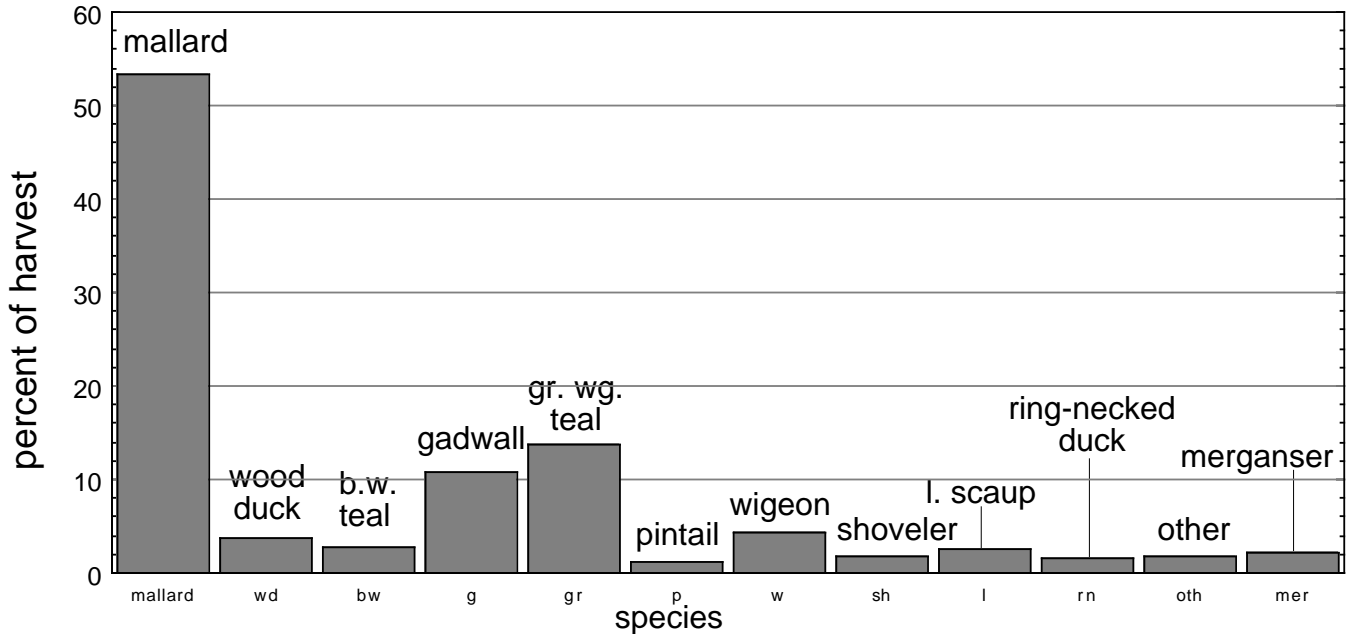

Figure 1. Species composition of the 1991-92 Kansas duck harvest.

Pair bonds remain strong until clutches are completed. Pairs begin to break up shortly after the start of incubation. However, females will readily reform pair bonds with the original male or another male if the first nest fails early in incubation or is destroyed by a predator.

Once a pair of mallards takes up residence on a pond or slough, potential nest sites are investigated shortly. Nests are usually located adjacent to water but may be up to a mile or more away. Nesting cover is variable because of the diverse habitats in which they breed. Grassy areas, brush clumps, sedges, and other natural vegetation may be used on the prairies and parklands. In agricultural regions, hayfields are preferred over other habitats.

The female scrapes a shallow depression on the selected site and begins to deposit her eggs. Hens usually lay one egg per day for nine to 10 days until the clutch is complete. After the last egg is laid, hens will incubate the eggs for about 25 days. If the nest is destroyed or eaten by a predator during egg laying or the early stages of incubation, the hen may reneest in another location.

It takes about a day for the ducklings to pip out of the egg, and soon after the ducklings are dry, the hen leads them to water. Hens and broods may move to other ponds in search of adequate food and cover. During drought conditions, mallards may move considerable distances in search of water. One study found that the broods traveled up to five miles from where they were hatched.

The down-covered ducklings grow rapidly. The birds are covered with down for 18 days, and their first feathers become readily apparent about the 25th day. The young are able to fly at between 40 to 60 days after hatching, depending on breeding locality.

Mallard drakes, who do not help the hens incubate the eggs, leave the nesting area shortly after incubation begins. At this time, the males gather on large bodies of water to molt (replace feathers). Nonbreeding drakes and hens that were unsuccessful in nesting arrive at the molting areas shortly thereafter. Successful nesting hens may or may not use the same molting areas after leaving the brood.

The fall migration of mallards usually occurs later than that of other dabbling duck species (see Chapter 10). The birds appear reluctant to migrate south as long as adequate food and open water are available to them, and some birds are known to spend the winter in these areas. Traditionally, the last big mallard migration flights south from the Canadian prairies may not occur until mid-November.

Early migrating mallards usually begin arriving in Kansas in October. Their numbers increase through November and early December, usually peaking in late December or early January. Mallards will winter in Kansas unless extremely cold, frozen water type conditions occur in combination with snow cover. The combination of snow, which makes feeding difficult, and cold weather will move mallards from the state. However, numbers often quickly rebuild as the weather moderates.

Kansas is a major wintering area for mallards in the Central Flyway. From 1975-80, Kansas reported 27.1 percent of the mallards in the Central Flyway during the mid-winter duck survey, the highest percent of any of the 10 Central Flyway states.

Contrary to the pattern of fall migration, during the spring mallards appear to rush back to the breeding grounds. Birds start to leave southern wintering areas in February. By early



April few birds remain on the wintering grounds.

Adaptability is the key for a species like the mallard that uses a broad range of habitats. Mallards eat both native and cultivated (agricultural) foods. Each of these food groups are equally important during some period of the annual cycle. These varied diets ensure that the ducks obtain nutrients essential for survival. Native foods are usually nutrient-complete, while cultivated foods may lack some essential requirements. Thus, cultivated foods can supplement but cannot totally replace native foods.

Fall and winter foods consist primarily of high-energy seeds from aquatic or emergent wetland plants and cultivated sources. Native foods include seeds from sedges, millet, smartweed, coontail, duck potato, duckweed, along with mast from nut-producing trees. Cultivated grains include corn, sorghum, wheat, barley, and oats. Mallards also feed on tubers and rhizomes of chufa flatsedge and bulrush.

In the spring, male and female diets vary because of differing nutrient requirements. Females seek protein-rich foods to obtain nutrients essential for egg production. Thus, their diets consist primarily of aquatic invertebrates such as midges, crustaceans, and mollusks. Males also use these tiny animals but may eat more seeds and other vegetative matter at this time. Male diets shift to animal matter during the molt because the birds need extra protein to replace feathers.

The summer diet of adults and ducklings is dominated by animal matter although plant foods are eaten when available. Mosquito, dragonfly, and other insect larvae, along with those listed previously, are readily eaten. By late summer, the diet shifts to include more high-energy foods in preparation for fall migration.



## Questions for Chapter 14

1. Describe the breeding range for mallards in North America. Which area(s) are the most important?
2. What is the “homing” ability of female mallard ducks?
3. Describe the food and cover requirements of mallards.
4. Describe a typical mallard nest.



## Chapter 15

## Geese

Ronald D. Pritchert and Robert M. Morton

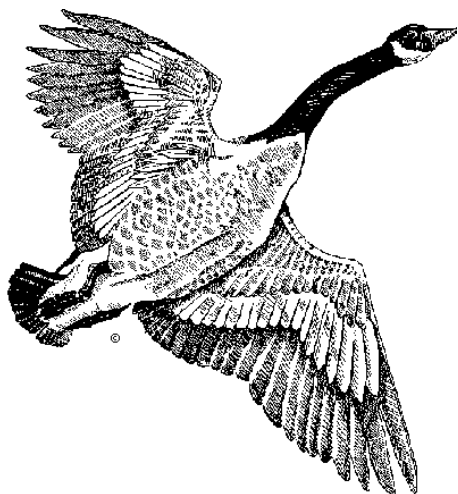

### Canada Goose

The Canada goose or “honker” is the species that most often comes to mind when one mentions the word “goose.” Although most people can easily identify this species, many are unaware that there are 11 recognized subspecies or races of Canada geese (Table 1). Identification of the different races is difficult and requires acute observational skills and a knowledge of feather coloration, body size and form, and habits. At times, even professional biologists resort to using the terms of small, medium, and large to describe mixed populations.

All Canada geese have a distinct appearance characterized by black bills, heads, necks, tails, feet, and legs. The birds have dark gray to gray-brown backs and a lighter gray breast complete with white cheeks and undertail markings. Sizes and weights of Canada geese vary depending on race. The smaller subspecies weigh about 3 pounds. Most migrants average about 8 pounds, with resident or giants averaging more than 10 pounds.

There are three “managed” populations of Canada geese which migrate through and winter in Kansas. These three populations are actually composed of a mixture of subspecies or races. The large Canada geese common to Kansas are called the Western Prairie/Great Plains Population. These birds nest from Oklahoma northward to the southern prairie provinces. These are the most southerly nesting geese common to the Central Flyway and also have the shortest migration route, wintering as far north as the Missouri River in North Dakota in recent years. It appears that cold weather alone will not move these birds south.

Unless heavy snow covers the waste grain that these geese feed on during the winter months, the largest concentration of this population, approaching 250,000 during some years, will be found on the Missouri River in South Dakota. Very few of these large birds migrate any further south than Oklahoma, with the vast majority of them wintering from Kansas northward.

The Great Plains portion of this population are those geese which have been restored to, and nest on, the U.S. side of the Canada border. These birds are a mixture of *Branta canadensis interior* and *B.c. maxima*, although most states just call them “giant” Canada geese (Figure 1). This population is probably the fastest growing population of Canada geese in the Central Flyway.

The Shortgrass Prairie (SGP) and Tallgrass Prairie (TGP) Populations are small Canada geese and are composed of a mixture of *B.c. parvipes* and *B.c. hutchinsii*. These geese nest in the Arctic, with TGP population breeding generally east of 105° West Longitude and north of 60° North Latitude, including Southampton and Baffin Islands. The SGP population nests in the Canadian Arctic from about 95° West Longitude west to the MacKenzie River and south into northern Alberta. Generally speaking, the TGP geese are more easterly and the SGP more westerly in their nesting, migration, and wintering range. In Kansas, the SGP geese occur roughly west of Highway 183, with the TGP occupying the remainder of the state.

These birds tend to move into Kansas earlier than the larger Canada geese, often arriving in good numbers as early as late October (Figure 2). They also differ from their larger relatives in that they usually migrate through Kansas, wintering from Oklahoma south to the coast of Texas.

Canada geese occur throughout the state of Kansas. However, major concentrations are found at the Kirwin National Wildlife Refuge, Cheyenne bottoms, Glen Elder Reservoir, Cheney Reservoir, Flint Hills NWR, Quivira NWR and the Marais des Cygnes Wildlife Area.

Kansas initially established breeding populations of giant Canada geese in four units (Figure 3). The program was expanded to other counties throughout the state in the early 1980s and continues today. These releases have been extremely successful in most sites. Today, flocks of resident geese are scattered across the state and provide recreational opportunities (consumptive and appreciative) in many regions where geese were once rare visitors.

**Table 1. Common name, species, and major flyway affiliation of North American geese.**

Common Name	Species/subspecies	Primary Flyway Affiliation
White-fronted goose	<i>Anser albifrons frontalis</i>	Central, Pacific
Tule goose	<i>A. a. gambelli</i>	Pacific
Snow goose	<i>Chen caerulescens</i>	Mississippi, Central, Pacific
Lesser	<i>C. c. caerulescens</i>	
Greater	<i>C. c. atlantica</i>	
Ross's goose	<i>C. rossii</i>	Central, Pacific
Emporer goose	<i>Anser canagicus</i>	Pacific (Alaska)
Brant	<i>Branta bernicula</i>	Atlantic Pacific
Atlantic	<i>B. b. hrota</i>	
Black	<i>B. b. bernicula</i>	
Canada goose	<i>Branta canadensis</i>	Atlantic Atlantic, Mississippi, Central Pacific Pacific Atlantic, Mississippi, Central Central, Pacific Pacific Central, Mississippi Central Pacific Pacific
Atlantic	<i>B. c. canadensis</i>	
Interior	<i>B. c. interior</i>	
Dusky	<i>B. c. occidentalis</i>	
Vancouver	<i>B. c. fulva</i>	
Giant	<i>B. c. maxima</i>	
Western	<i>B. c. moffitti</i>	
Taverner's	<i>B. c. taverneri</i>	
Richardson's	<i>B. c. hutchinsii</i>	
Lesser	<i>B. c. parvipes</i>	
Aleutian	<i>B. c. leucopareia</i>	
Cackling	<i>B. c. minima</i>	

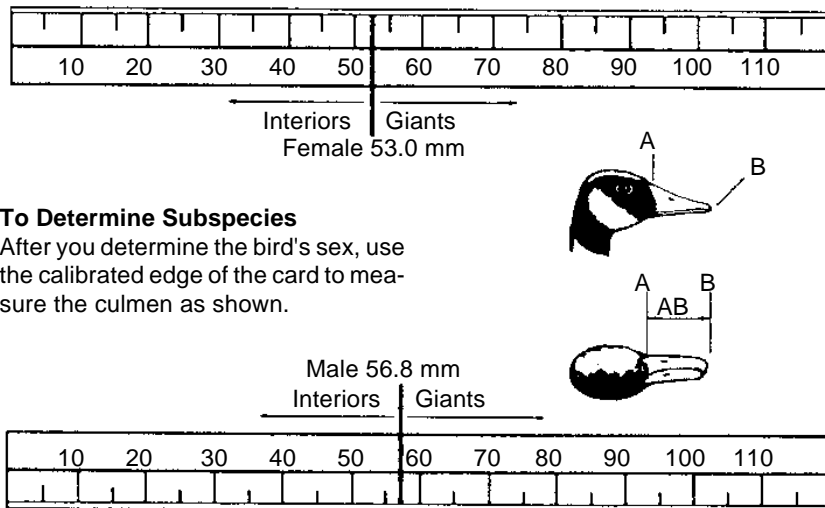

Figure 1. A quick method for determining the difference between interior and giant Canada geese.

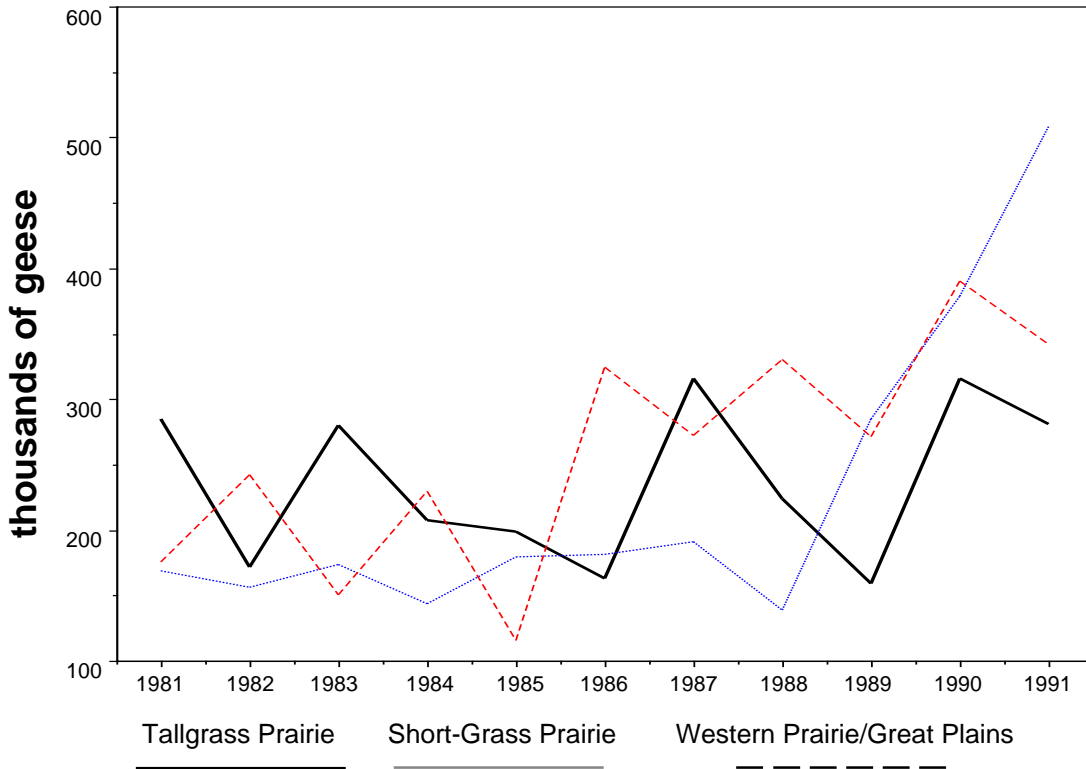

Figure 2. The population size of various Canada goose populations common to Kansas, based on mid-December inventory data.

**Habitat**

Canada geese, as with all waterfowl, are closely tied to wetlands. Shallow marshes and lakes, along with the exposed flats of coastal marshes, provide food and loafing areas for the geese. Large deep-water lakes, bays, and inland rivers that are close to shallow water areas are used as roosting habitat because they are relatively free of predators. Breeding habitats used by geese may vary widely because different goose populations nest in different ecosystems.

The one important part of breeding habitat is that all are in close association to permanent wetlands. Wintering habitats

include major river drainages, marshes, lakes, and reservoirs in the middle and southern United States. Major wintering areas are usually those locations that provide feeding, loafing, and roosting habitats with little or no disturbance.

Modern agricultural practices provide waste grain and forage crops that are important parts of a goose’s diet during winter. During the spring and summer, geese eat native foods, such as seeds, stems, and roots of wetland plants (bulrush, smartweed, nutgrasses, and wild millet). They occasionally eat invertebrates during the reproductive period to supplement protein needs for egg production.

**Natural History**

Canada geese form pair bonds in late winter before or during spring migration. Once the birds pair, the bond remains steadfast for life unless one of the pair dies. Most Canada geese do not attempt to nest until their third spring. The birds usually begin nesting in early May. Throughout their breeding range, Canada geese are adaptable in their choice of nest sites. Their nests are made on elevated clumps in tundra, mats of marsh vegetation, muskrat houses, and man-made platforms as well as in hay stacks and occasionally trees.

Once the eggs are laid, Canada geese defend territories associated with their nest site. The size of this territory varies greatly within the breeding area depending on the age of the breeding birds and the amount of surrounding

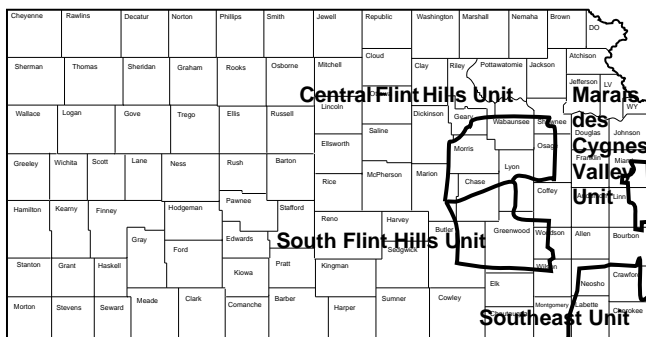

Figure 3. Kansas Dark Goose Management Units.

plant cover. Both the male and female use aggressive calls and displays to defend the territory.

Female Canada geese lay four to seven eggs in a nest (the average is five). The females incubate the eggs while the males stand guard a short distance away. The females usually leave the nest for short periods each day to feed. Twenty-five to 30 days after incubation the eggs hatch. Typically 50 to 70 percent of the nests produce young birds. The primary reasons for nest failures are desertion, destruction of the nest or eggs by predators, inclement weather, and other natural agents. Arctic breeding geese seldom attempt to renest after losing a clutch because the arctic summers are too short to permit females to replace necessary body reserves and produce a successful nest.

Both parents protect the young from the time they leave the nest through the brood period. Females brood the young at night and several times throughout the day during the first week after hatching. Brooding is reduced as young birds develop and can better regulate their own body heat.

At this time, males defend a small area around the brood from other geese. However, day-to-day interactions between families allow some broods to mix and form gangs. Gang broods of 100 young and several pairs of adults have been reported. Young Canada geese are able to fly in about 63 days after hatching. About 70 percent of the goslings reach flight stage.

Fall migration begins in August when family groups gather on wetlands in central Canada (called **staging areas**). Traditional staging areas are used year after year as a gathering place before the birds leave on the fall migration. The number of geese assembling at these staging areas varies each year. Canada geese migrate as family groups. The large flocks people see are simply several family groups along with paired and single birds.

The first migrants appear in Kansas in mid-September. Populations slowly build through October, November, and early December. The major push of geese into the state usually occurs in late December or early January when late migrants are forced out of northern areas by winter weather.

Kansas' wintering goose populations are extremely variable, ranging in size from 16,500 to 200,000. The size of the winter population depends on conditions farther north.

### *Past Management*

Canada goose management in Kansas has focused on harvest management. This was accomplished by adopting restrictive regulations to protect populations that we wished to increase and through effective refuge management, which provides a safe haven for the birds in a localized area without special restrictive regulations.

An example of how regulations have been utilized would be those years when the limit on Canada geese was too early in the season, to allow greater harvest of the small

TGP Canada geese which migrated into and out of Kansas early in the fall, and then switching to a limit of one Canada later in the year, to provide protection of giant "restoration" geese which moved into Kansas late in the season. In recent years, the status of these populations have reversed, and the limit now is one Canada early and two Canada's later in the season.

Another type of regulation which has been utilized during recent years is one that requires a permit to harvest a goose, with a limit of one or two permits per individual. This is basically a "season limit," and is more restrictive than can be accomplished with daily limits. It has been used in the Kansas Resident Dark Goose Management Units to allow a very controlled, measurable harvest of our restoration birds.

Along with harvest regulations, refuge management is necessary to building a goose flock in an area. Without some type of refuge which provides sanctuary, food, and water, the geese are harassed out of the state in a very short period of time. There are no major concentrations of geese in any mid-latitude states that are not associated with a refuge of some type.

## White-Fronted Goose

White-fronted geese are preferred by many goose hunters, possibly because they are not quite as common as Canada and snow geese and possibly because they are rated as the best flavored of the goose species that frequent Kansas.

The western segment of the Mid-Continent White-Fronted Goose Population moves into and through Kansas while moving south to wintering areas on the coast of Louisiana and Texas. During the northward spring migration, both the western and eastern segments move through Kansas and on their return trip to the breeding grounds. There is increasing evidence that there is considerable mixing of these two populations, and that they may indeed be only "one" population. Together they number about 250,000, based on coordinated surveys done by the Central and Mississippi Flyways.

White-fronts are easily identified by their feather color. The body is primarily brownish-gray with black streaks on the underbelly (hence the name specklebelly). Adults have a pinkish bill with some white feathers around the border of the head. This characteristic gives the white-fronted goose its name. Adult white-fronts have orange legs, whereas juveniles have a yellowish bill and legs. A white patch on the rump is easily seen on birds in flight.

North America white-fronted geese breed in central and western Canada. The birds build nests in sedge marshes along tidal flats and in tall grassy upland areas close to water. A female selects a small depression to build her nest, using nearby plant material and body down. She lays about



five eggs which are incubated 23 to 25 days. It takes about a day for the brood to hatch.

After the brood is hatched, the parents lead them from the nest. It is interesting to note that the male assumes the primary role in the development of the young birds. The young develop rapidly and are able to fly in about 45 days. The birds develop strong family bonds that remain intact until the next spring. Yearlings are then driven off by the parents at this time. Yearling geese do not pair or breed the first year but sometimes breed their second year.

Modern agricultural practices have benefited specklebelly populations. Rice, milo, and barley are preferred agricultural foods. The birds eat watergrass, sedges, and some upland grasses. Occasionally, the geese feed on waste grain or on winter wheat and clover.

White-fronted geese are usually seen as singles, in pairs, or in small flocks on wintering areas. Geese migrating during fall sometimes gather in large concentrations until they reach the wintering area.

## Snow Geese

The Mid-continent Snow Goose Population is the largest of all North American goose populations, exceeding 2,000,000 during the 1990 and 1991 Coordinated Mid-December Goose Surveys. This is almost twice the population objective established in the management plan for these birds.

Lesser snow geese occur in two color phases (white and dark). These different phases are commonly called snow goose and blue goose, respectively. Immatures of both color phases have a dull "sooty" plumage, dark legs and bill, and an overall drab, dirty appearance. Adult white-phase birds have white feathers with the exception of black wing tips. The blue phase is characterized by a slate blue-gray body, black wing tips, white head, and neck. Both color phases have pink bills, legs, and feet.

Most snow geese breed in North America and eastern Russia. Some snow geese are occasionally seen in Europe and western Russia. Snow geese reproduce in large colonies found on low grassy tundra plains. These colonies are often within a few miles of the sea and up to 80 miles inland along adjacent rivers. The birds begin pairing on the breeding grounds during the second year when young geese become sexually mature; however, breeding is usually delayed until the third year. Nest densities in colonies average 12 nests per acre. Snow geese establish their own territory in the colony, and both sexes vigorously defend territories from other snow goose pairs.

Snow goose nests begin as scrapes on the ground, which the female gradually enlarges. She adds moss, willows, and grass to form a substantial raised nest. She deposits a small amount of down in the bowl with the first egg and adds more down with the third and fourth eggs.

The timing of nest initiation is critical because weather conditions and snow-melt dates greatly influence reproduction. If there is a long delay between when the birds arrive on the breeding grounds and the beginning of nesting, it can result in a reduction in the number of eggs laid. Snow geese lay between two to 10 eggs (the average is five). Average incubation lasts about 23 days. It takes about one and a half days for the entire clutch to hatch.

Lesser snow geese are extremely successful nesters except during years of severe weather. Both parents guard the brood; however, only females brood the young. Brooding ceases when the young are 2 to 3 weeks old. The long daylight period on arctic breeding grounds allows young snow geese to feed for extended periods. Thus, the birds grow rapidly.

Family ties among snow geese are not as strong as those among white-fronted geese. Individual broods may form groups and move together. Frequently, several broods will join together to form a gang brood that may include several adults moving together as one unit.

Snow geese migrate in large flocks of 100 to 10,000 or more. These flocks are made up of individuals, pairs, and families. Snow goose migrations often begin after sunset and continue throughout the night. The birds begin to stage for fall migration in mid-August, and many of the flocks are on the move by mid-September. Most snow geese usually arrive on their wintering areas by mid-November. The birds begin leaving for the breeding grounds by late February. Most of the geese are moving to northern breeding areas by mid-March. Spring arrival on the breeding grounds is generally completed by early June. Wintering snow geese typically use coastal marshes and major river drainages as winter habitats. They also use upland agricultural lands during migratory and wintering periods. They eat primarily sedges, grasses, and other vegetation on northern breeding areas. They supplement their diet during migration and winter with agricultural grains, including corn, rice, and winter wheat.

Snow geese in North America migrate through the western Mississippi, eastern Central, and Pacific flyways. Louisiana, Texas, and Missouri have the largest wintering concentrations of snow geese. In Kansas, the largest concentrations of snow geese occur in the northeast corner of the state and are usually associated with the Squaw Creek NWR or the ITAN Power Plant Lake located in Missouri. There are also flocks of 5,000 to 30,000 located on public lands at Elk City Reservoir, Flint Hills NWR, Perry Reservoir, and Tuttle Creek Reservoir. Peak numbers of snow geese usually occur sometime in November, peaking around 50,000. However, if snow geese moving into the northeast corner of the state from Missouri to feed are included, the count may approach 400,000.







## Chapter 16

# Management of Native Grasslands

## Introduction

*Jerry Tomanek*

When pioneers first ventured into Kansas, they found a state almost completely covered by grassland. A small fringe of oak-hickory forest was found along the eastern border, but its extent was very limited by naturally occurring prairie fires. Weaver (1954) often limited his definition of prairie to the taller grass, moister regions along the eastern border, as differentiated from the Great Plains grassland. However, the entire grassland area will be called prairie since the only difference is in the stature and composition of the plants. This difference is in direct correlation to the availability of moisture (Weaver and Albertson, 1956).

The prairie vegetation originated many million years ago as a result of the Rocky Mountain Uplift, which followed the disappearance of the Inland Sea, and drastically changed the climate, especially reducing precipitation. The mountains intercepted the moisture-laden winds from the Pacific Ocean, and as a result, the major portion of the precipitation occurred west of the mountains. Thus, the more arid climate to the east supported only grasses and forbs. Trees were limited to areas along streams or on other more favorable locations, such as on rapid moisture-infiltrating sandy soils.

The central portion of the prairie extends from central Canada to Mexico and covers all or portions of states from Minnesota, Illinois, and Ohio west to Montana and Wyoming and south to Texas, New Mexico, and Arizona. In general, it is the dominant vegetation between the Rocky Mountains on the west and the deciduous forest on the eastern border.

When many of the early pioneers from the eastern forested regions first saw the prairies, they described them as monotonous. But, they cherished the rich soil for growing crops and the lush grasses for their grazing animals. Soon, they learned to love the prairies with its diversity of plants, especially when it bloomed like a large flower garden. Often, as many as 250 to 300 kinds of plants could be found on a small area of prairie.

Although there have been many prairie types identified, the principal ones recognized by most ecologists in this area are tallgrass prairie, true prairie, mixed-grass prairie, and short-grass plains. One of the criteria for identifying the prairie types is the stature or height of the dominant grasses. Grasses have generally been divided into tall grass (5 to 8

feet or more), mid grass (2 to 4 feet) and short grass (0.5 to 1½ feet). The relative composition of the height classes helps to identify the types. For example, the dry, western short-grass plains are dominated by two drought-resistant short grasses, blue grama and buffalo grass. Only the most favored sites that receive excess runoff, such as the lowlands or those protected from desiccating winds on north-facing slopes, have some mid and tall grasses. However, the short grasses are the dominants. In the mixed-grass prairie the short grasses are the dominants and are found mostly on the arid hilltops or on the dry, upper, south-facing slopes. The mid grasses are common elsewhere with the tall grasses limited to the moister locations, such as the lower slopes and lowlands.

The true prairie is dominated by mid and tall grasses with mid grasses on the drier locations and tall grasses in moister areas. Occasionally short grasses are found on extremely dry sites, but they are an insignificant part of the total vegetation. The tallgrass prairie is not as extensive as the other types and borders the deciduous forest. Occasionally islands of tallgrass prairie appear on the drier sites of the forested regions. In fact, there were patches of tallgrass prairie in most of the original forests of eastern United States. They were the first to feel the effects of pioneer's plow.

Kansas has examples of all these types with the short-grass plains in the west, the mixed-grass prairie in the central portion, the true prairie represented by the Flint Hills, and the tallgrass prairie on the eastern border. Because of the control of fire by the pioneers much of the tallgrass prairie has been invaded by the oak-hickory forest. Most of what has not been invaded has been cultivated.

Although there are about 200 species of grasses in Kansas, only about 10 or 12 dominate the Kansas prairies. The dominants (abundant, controlling species) of the short-grass plains are blue grama and buffalo grass with small amounts of side-oats grama, western wheatgrass, and the bluestems. The mixed-grass prairie has a number of dominants including side-oats grama, blue grama, little bluestem, big bluestem, switch grass, and western wheatgrass. Many other grass species are found in this type but in smaller amounts. The true prairie is dominated by big and little bluestem but also with significant amounts of Indian grass, switch grass, tall dropseed, western wheatgrass, and the grammas. Many other species are present but are of little significance. It is primarily a mid-tall grass type. On the other hand, the tallgrass prairie is dominated solely by four tall grasses—big bluestem, Indian grass, switch grass, and prairie cord grass. Even mid grasses, such as little bluestem

and Canada wildrye, often grow to heights of 5 feet or more.

Although grasses are dominant in the prairie, many non-grassy, broad-leafed plants are found throughout. These forbs can be separated from the weeds in that the forbs are native to the prairie, and many are quite desirable either as forage or soil builders. Weeds, on the other hand, are often introduced and mostly undesirable.

The most important living thing on this planet is a green leaf—a blade of grass—and its potentialities (Gates, 1937). Animals, as well as man, are entirely dependent on plants, especially the grasses. Native grasses and forbs are the most important food sources for grazing animals. Besides their food function, they also serve as soil builders and help prevent soil and water erosion.

A favorite passage about grass can be found in Alan Patton's "Cry the Beloved Country," in which he said, "The grass is rich and matted. It holds the rain and mist and they seep into the ground feeding the streams. Stand unshod upon it, for the ground is holy being as it came from the Creator. Keep it, guard it, care for it, for it keeps man, guards man, and cares for man. Destroy it and man is destroyed."

The early pioneers thought the prairie was indestructible, and they tried to prove it. They severely overgrazed much of the native grassland and, as a result, decreased its productiveness and, in some cases, almost destroyed it. This was especially true during the drought years of the 1930s. In western Kansas some of the short-grass prairies were so denuded that they were a source of dust for the infamous dust storms in that area. Drought and overgrazing are individually destructive to prairie, but occurring together they are devastating (Tomanek, 1959).

Fortunately, we have learned better methods of utilizing the prairie and still maintain its productiveness and other good qualities. The science of range management came into being to combat the near destruction of the prairie, and the results have been encouraging. The most recent methods of management are discussed in the following section.

## Management Practices

*Paul D. Ohlenbusch*

The principles of grazing management are concepts to manage by. The plant growth and management requirements plus the production characteristics of the forages available or that can be established are the second major information base needed. By combining these two information bases with the management and nutrient requirements of the grazing livestock, a management program can be developed to harvest the forage produced and market a quality product. The management program is developed using tools that can accomplish management goals. After the management program is developed, financial budgets are developed to determine the economic feasibility of the program.

Applying the management practices available is more than simply selecting the tool and "plugging it in." Decisions must be made about the many related management practices in use as you consider a use or change. As stated in the section on Grazing Management Principles: **All** grazing management decisions are long term. What you do to a plant this year (together with the past year or years) will affect how the plant performs in the future. The basis for this statement is that the first four to six weeks of spring growth is made from food reserves laid down during the late summer and fall the previous year. How well the plant starts in the spring determines its production for the year. Add to that the effects of defoliation (grazing), and the long-term management needs are very important. To put it in a shorter statement: There are no short-term decisions in grazing management.

To apply the management practices that are most useful, take a look at each one and gain an understanding of its role in management, the expected results, the inputs needed, their relationship with other practices, and the time (for labor and management) required to implement and use the tool. Once this information is understood, a management evaluation of the tool can be made. Additional ones are available but are rarely used.

### *Grazing Distribution*

Distribution of grazing by livestock over rangeland is essential for the effective use of the forage resource. Obtaining uniform use patterns over the entire grazing area from the first day of grazing is of very high importance since livestock establish their grazing habits when they first enter a new pasture.

### **Practices for Grazing Distribution**

There are several practices that can be used in grazing distribution. These can be divided into two groups. The first being normal management practices, and the second is management changes and/or capital improvements.

### **Management Practices**

Among the easiest practices to use in managing grazing distribution are salt/mineral feeders, oilers, dust bags, or rubbing posts, winter feeding, and prescribed burning.

Moving salt/mineral feeders away from water is one way of improving grazing distribution. The new salt/mineral location should be in undergrazed areas, and the livestock should know where the new location is. Move the salt/mineral feeders whenever livestock congregate and begin to trample the vegetation. Traditionally, people have said that livestock must have water after salting. Recent information indicates that livestock do not utilize salt or mineral and then water or vice versa. In areas where water has a high salt content or natural salt licks occur, changing salt locations will not work.

Oilers, rubbing posts, or dust bags can be used in the same way as salt and mineral feeders. Cattle will come to these, but they should not be located with the salt/mineral or left by water. Oilers or rubbing posts should not be placed between water and salt or salt between water and the oilers. They should be used at locations throughout the pasture as needed to gain uniform use of the pasture.

Probably one of the most under-utilized tool of grazing distribution is winter feeding. Feeding in those parts of the pasture which have not been utilized and moving the feeding grounds throughout the under-utilized area will make the area more desirable for livestock grazing.

Feeding livestock on grazingland results in over utilization or trampling of the vegetation where feeding occurs. Continual feeding in the same location will bare the area, opening it to erosion. In the spring, the bare areas will be the first to green up with cool season species, and the livestock will begin grazing these areas first. Once the pattern is established they will return to the area throughout the season.

Prescribed burning can be a grazing distribution tool. When distribution problems exist, annually burning those areas which will burn, together with the previously mentioned practices, can change the grazing distribution on the pasture. Livestock will prefer forage on burned areas.

Several options are available which require changes in management or the outlay of capital. One management change that can accomplish better grazing distribution is the spot treatment of under-utilized areas with fertilizer or fire. It is possible to promote livestock use by fertilizing small areas (2 to 5 acres) or spot burning (5 to 10 acres) in areas of under-utilization. These practices should be limited to extreme cases where management practices have not accomplished grazing distribution changes. No attempt should be made to utilize the same area for spot treatments for two years in a row. It should be moved to a new area each year.

### Capital Improvements and Management Changes

If normal management distribution aids fail to produce the desired results, a management change or capital improvement is often necessary. Included are water developments, fencing, and more intensive grazing management options.

### Water Development

Water is the most useful grazing distribution tool, although it represents a major capital outlay. It has the greatest effect on grazing distribution through the proper location and development of water sources. It is also one of the most expensive to develop.

If a new water location is needed, it should be developed considering three criteria: 1) water quality; 2) amount of water available; and 3) location within the pasture.

Quality and quantity of water are the most important factors in developing a new watering location. If a new

water source is developed in a pasture to be used with an old pond, the distribution pattern may simply be reversed, since the quality of the new water source may be much higher than that in the pond. By having the new water source controllable (it can be turned off and on), the livestock can be moved from one watering source to another. Water developments include ponds, springs, dugouts, windmills, water wells, and pipelines.

If a new pond is being built, lay a water line under the dam and develop a trough below the dam. By fencing out the entire pond, the quality and quantity of the water available is increased as well as the investment in the pond protected. Excluding livestock will prevent them from walking on ice during the winter, reducing the probability of livestock falling through ice and drowning, and prevent livestock from bogging down in silt during periods of drought or low water. Also, livestock walking on the dam will shorten the life of the structure.

For large pastures, locate water sources so livestock do not have to travel more than  $\frac{1}{2}$  to  $\frac{3}{4}$  mile in rough terrain and no more than  $1\frac{1}{2}$  miles on level terrain. Distance between water sources must be taken into account to ensure that animals can readily travel to all parts of the pasture. Small ponds, pit ponds, and spring developments should be utilized whenever possible instead of developing large ponds, windmills, or water wells. A new option for shallow wells and wet areas where spring developments are not possible is the solar-powered pump. In areas where water is difficult to obtain, pipelines can be used very efficiently to transport water over long distances.

### Fencing

One of the most effective management changes is cross fencing large pastures to separate vegetation types or topographic areas which influence the grazing of livestock. Cross fencing should consider the following in determining where to fence: 1) current grazing patterns; 2) barriers (vegetation types, topography, water locations, etc.) to livestock movement; and 3) manageability of the resulting pastures.

Cross fencing can be done using conventional barbed wire fences (3 wire) or high voltage-low impedance electric fencing (Australian-New Zealand type). The latter is the most cost effective and is considered semi-permanent.

### Grazing Management Options

The use of intensively managed or rotation grazing to utilize forage with larger numbers of animals in shorter time periods is another option. This brings about more uniform grazing of the entire area but requires a much higher level of management than necessary under continuous or season-long grazing. Normally, rotation grazing will require cross fencing, water, or other adjustments in order to accomplish the management change.

## Summary

Grazing distribution is a major consideration in grazing management. Uniform distribution of grazing by livestock over grazingland is essential for the efficient use of the forage resource. Obtaining uniform use patterns over the entire grazing area from the first day the pasture is used is of very high importance since livestock establish their grazing habits when they first enter a new pasture.

## Prescribed Burning

Fire was a part of the development of the Great Plains grasslands. Natural fires, started by lightning, burned areas whenever conditions were favorable. Based on early records, these fires varied from only a few acres to some that covered thousands of acres and lasted for weeks. In addition, the Plains Indian was responsible for starting fires to attract game into certain areas.

To the early settlers, fire was a feared enemy destroying everything in its path. As more settlers came, roads, fences, plowed fields, and overgrazing created barriers reducing the extent of wildfires. These obstructions reduced the occurrence of wildfires to the point that large wildfires were rare.

In Kansas, this same pattern was followed except in the area known as the Flint Hills. Here, fire was and still continues to be used virtually uninterrupted. As a result, large expanses of almost treeless prairies are common in the central and southern Flint Hills. Fire plays an important role in preventing the invasion of woody plants. In some areas, woody plant invasion has progressed to the point of forming closed woodland communities. In these areas, essentially no grass remains.

The use of fire as a management tool is steadily spreading westward across the state. Its use in western Kansas is primarily limited to controlling brush and weeds and improving grazing distribution. Using fire will also be limited to certain moisture and weather conditions.

## Benefits of Prescribed Burning

Research and experience have shown that fire can be used as a major management tool for native grasslands, native hay meadows, and in establishing new native grass stands. It can recycle nutrients tied up in old plant growth, stimulate tillering, control many woody plants and herbaceous weeds, improve poor grazing distribution, reduce wildfire hazards, improve wildlife habitat, and increase livestock production in stocker operations. To gain these benefits, fire must be used under specified conditions and with proper timing. This is termed "prescribed burning."

## Timing

Timing of the burn is the most critical element for obtaining the desired response. The kinds and amounts of

various plants in a rangeland area can be changed by fire. The presence and abundance of plant species, forage yields, and range condition are all affected by the time of burning.

To control or reduce undesirable plants, they should be burned at the weakest point in their growth stage. In order to damage a particular plant, burning must occur when the plant is actively growing or has buds above the soil surface which can be destroyed. For perennial plants, the plant's food reserves should be at or near their lowest point, so regrowth would be difficult. Annuals, that have their growth point above the soil surface, will be damaged or destroyed by a fire.

Some examples of how fire affects plants may help in understanding why timing is important. Buckbrush (coral berry), a woody perennial, must be burned in late spring for two to three consecutive years to effectively control it. During late spring, it is actively growing and fire destroys its top growth. Regrowth is slow since its food reserves are low. Successive burns prevent build-up of these reserves and kills the plant. Smooth sumac, another woody perennial, has a life cycle similar to warm-season grasses in that it does not reach the lowest point in its food reserves until late May or June. Burning in late spring will kill the top growth but results in an increase in the number of stems. The net result is an accelerated increase in the size of the smooth sumac invasion area. Eastern red cedar is readily killed by burning, especially when it is less than 5 feet in height. It does not have buds which can resprout, so when this plant is defoliated, it dies.

Much the same response can be obtained with forbs. Western ragweed and western ironweed are perennial forbs which can be reduced with two or three consecutive annual burns.

Fire can also reduce the amount of undesirable grasses. Low-producing, cool-season grasses, such as Kentucky bluegrass and annual bromes, are greatly reduced by a late spring fire. They are actively growing at the time of the burn and have difficulty regrowing after the burn.

Burning to favor desired grass plants should be done when they are just starting to green up. The grasses should have 1 inch of new growth when they are burned. This occurs in mid to late spring. At this stage, the plants are able to grow quickly. Ideally, the soil profile should be full of water at the time of burning and the surface should be damp. Big bluestem and Indiangrass are increased when the range is burned in late spring. The amounts of sideoats grama, blue grama, and buffalograss increase only slightly. Little bluestem and switchgrass decrease or are maintained by a late spring burn.

Average recommended burning dates are shown in Figure 1. It should be noted that these dates may be as much as 10 days earlier or later depending on growing conditions.



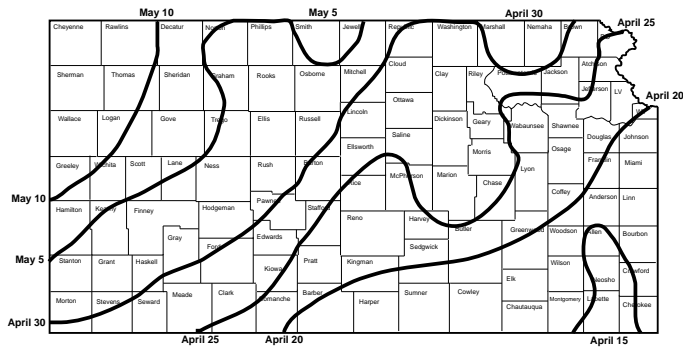

Figure 1. Recommended burning dates.

**Forage Yield**

Forage yield is affected by the timing of the burn. Research done at Kansas State University has shown that the earlier the burning date, the lower the forage yield (Figure 2). The difference in forage yield between the late spring burn and unburned range is not significant.

The changes in forage yield due to the burning date are due to moisture and temperature changes. Soil moisture in early burned areas can evaporate at rates as high as one-half inch per week. Also, rainfall can result in soil puddling and rainfall may not be taken into soil as readily as on the late burned or unburned areas. Soil temperature rises quickly following the burn as sunlight warms the darkened soil (old growth insulates the soil) and results in faster plant growth compared to non-burned areas. Properly timed, there is little change in soil moisture conditions, soil structure, and soil erosion due to runoff.

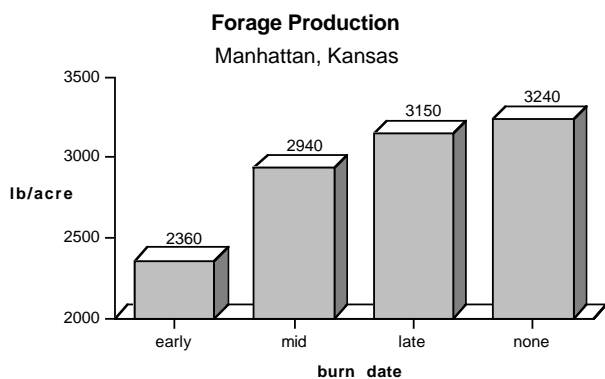

Figure 2

**Grazing Distribution**

Fire is an excellent management tool for improving grazing distribution. Areas that are not usually grazed or are undergrazed can be burned. The animals are attracted to the grasses in the burned areas since they are more accessible and palatable. The overgrazed areas generally will not have enough fuel to carry a fire and will be used less and can recover. Burning will change the grazing pattern and even

out the grazing distribution. Prescribed burning also has great value in reducing grazing distribution problems caused by a wildfire over part of the pasture.

**Livestock Production**

Research shows that stocker animals can gain 10 to 12 percent more on late spring burned than on either unburned or early burned pastures (Figure 3). This response is apparently due to higher quality forage being available in the first half of the grazing season. These benefits are realized only during the year of burning.

Cow-calf gains on burned pastures have not shown any significant differences from unburned. Burning is primarily done to control weeds, cool season grasses, and brush; improve grazing distribution; and reduce litter buildup. The benefits of burning to the cow-calf operator are in maintaining a highly productive grassland. Without burning, litter can accumulate and reduce grass production. A program of burning two or more consecutive years and then waiting until needed again is adequate to provide the above benefits.

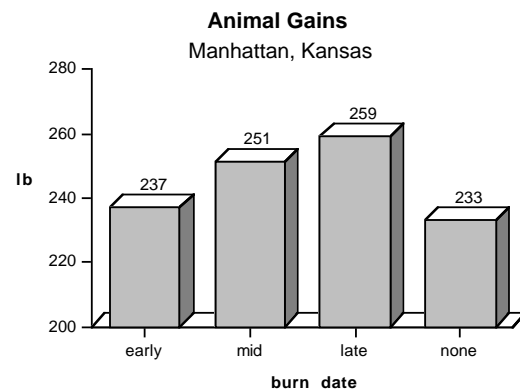

Figure 3

**Hay Meadows**

Prescribed burning should be used on hay meadows to stimulate tillering, control weeds and brush, and remove old mulch left by haying. Timing of the burn is the same as native grass pastures. A program of burning two or more consecutive years and then waiting until needed again is adequate to provide the needed benefits.

**Wildlife**

The majority of the wildlife on the Kansas prairies evolved with the grassland. Fire is a critical factor in wildlife habitat management. Properly timed burns can increase desirable warm season grasses and forbs which improve food supply, and nesting and brood rearing cover for ground-dwelling birds. Early spring burns are preferred over late burns for maximum wildlife benefits. In addition, removal of the litter improves access to insects while

**Table 1. Preferred soil moisture and surface moisture conditions needed to insure a proper burn on established CRP native grass stands based on location or soil characteristics.**

Location or Soil Conditions in Kansas	Soil Moisture <sup>1</sup>	Surface Moisture <sup>2</sup>
Eastern	enough to ensure growth to cover the soil surface after burn	damp
Central	moisture to major rooting depth	damp
Western	moisture to full rooting depth	damp
Sandy soils	moisture to full rooting depth	damp to moist
Sub-irrigated soils	enough to ensure growth to cover the soil surface after burn	damp

<sup>1</sup> Rooting depth varies with soils. Normally, the rooting depth should be considered as either the soil depth to an impervious layer that restricts root growth or the soil depth to which heavy root growth penetrates.

<sup>2</sup> Damp = wet to touch but no free water. Moist = excess water when soil is squeezed in hand.

increasing mobility and brood survival of the birds. Prescribed burning also benefits some wildlife by controlling woody vegetation. Prairie chicken populations will decline if woody vegetation becomes too dominant. Prairie chicken booming grounds may be abandoned when vegetation from the previous year is so dense or tall that courtship activities are inhibited. Bobwhite quail show remarkable responses to fire management. Feeding, roosting, and travel are enhanced for quail on newly burned ranges. One and 2-year-old burns provide greater amounts of quail food than older burns. Not burning all pastures in a grazing unit the same year will result in more diverse vegetation so birds will have suitable areas for nesting, brood rearing, and winter cover.

### Native Grass Seedings

Experience has shown that prescribed burning can be used to hasten the development of newly seeded native grasses. As early as the spring after the seeding year, burning stimulates tillering, controls annual weeds, and removes accumulated mulch. Care should be exercised that soil moisture is adequate to ensure regrowth after the burn.

### Wildfire Hazard Reduction

Reducing the wildfire hazard with fire may seem unusual. In years of high precipitation or underuse, large amounts of old growth accumulate. This litter provides ideal conditions for wildfires to occur during dry periods. Burning in late spring will remove this hazard, thereby reducing the possibility of large and extremely hot, damaging wildfires.

### Effects on Soil Conditions

When a fire is properly timed, there is little change in the soil moisture conditions. The earlier the rangeland is burned, the greater the loss of moisture. The soil surface readily absorbs heat so that evaporation rates are greatly increased.

Soil moisture should be considered in the timing consideration. Table 1 defines the preferred soil moisture conditions for a successful burn.

When soil is exposed to the action of heavy rain, the surface structure of the soil may be destroyed. This makes it more difficult for water to get below the soil's surface layer. The longer the time between the burning date and when the warm season perennials start to green up, the greater the problem.

Properly timed burns are done when the warm-season perennials are starting to green up. This allows them to grow quickly, so the bare soil surface will only be exposed for a very short period of time. This reduces the erosion hazard, reduces evaporation, and allows water to penetrate the soil.

### Air Quality

One of the primary components of smoke is particulate matter. Particulate matter is one of six substances of such national concern that a national ambient air quality standard has been set for the concentration of particulate matter suspended in the air. Fortunately, at this time the concentration of particulate matter in the air in Kansas does not exceed the national ambient air quality standard. For this reason, Kansas is able to allow agricultural burning in the manner prescribed.

However, it should be kept in mind that the emissions from open burning are uncontrolled and can have negative consequences. Therefore, prescribed agricultural burning should be conducted only when necessary and when other ways to accomplish the objective of the burn result in greater overall harm than does the uncontrolled release of smoke into the environment.

### Summary

Prescribed burning is a major management tool for rangeland. Properly used, it can be a cost effective method for increasing the productivity of rangeland as well as controlling many undesirable plants. It can also reduce the hazards of wildfires and benefit domestic livestock and wildlife.

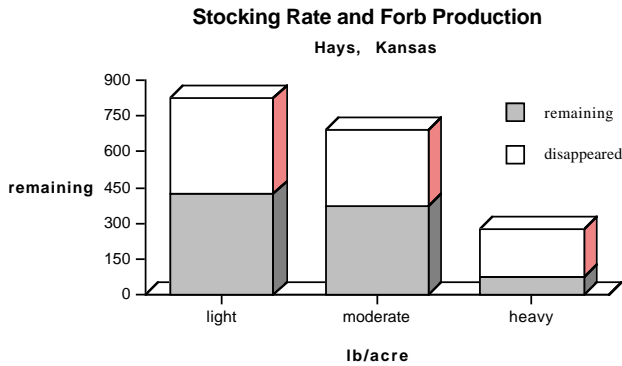

Figure 4

### Rangeland Weed Management

Rangeland plants that are not readily grazed by livestock generally have been considered undesirable weeds that should be eliminated. Many plants regarded as weeds, however, are intricate components of the grassland ecosystem. Therefore it is important to distinguish between desirable rangeland species and weeds that adversely affect forage or livestock production.

### Weeds and Forbs

A weed is any plant growing where it is not wanted. In general, weeds are opportunistic plants that compete with desirable forage for moisture, nutrients, and space. Forbs are broadleaf herbaceous plants that may be either desirable or undesirable. The presence and abundance of weeds and forbs help determine range condition and are useful indicators of management problems.

Livestock routinely graze forbs to help meet nutritional and dry matter requirements. Native legumes, such as cat claw, sensitive briar, partridge pea, and leadplant, are palatable and provide a good source of protein. Some perennial forbs, such as black samson and compass plant, are relished by livestock and will decrease under heavy grazing. As stocking rate increases, desirable forb production decreases (Figure 4).

Grazing intensity also influences the relative abundance of undesirable forbs and grasses. Perennial forbs, such as verbena, goldenrod, and ironweed, and many annual forbs, such as broomweed and snow-on-the-mountain, are not eaten by cattle and increase on rangeland that has been overgrazed. Annual bromes (Japanese brome, downy brome, and cheat) will persist in lightly stocked and moderately stocked pastures; however, in heavily stocked pastures, the annual bromes are grazed out and replaced by little barley, an unpalatable annual grass.

Some weeds are unpalatable when mature but are grazed when they are young. Western ragweed contains over 20 percent crude protein and is palatable in the early growing season; however, cattle will not eat mature ragweed. Annual bromes also provide forage in the early

growing season, although extensive stands will reduce warm-season grass production and overall livestock gains.

Removing weedy species which are competitive with perennial grasses can increase forage production. Rhizomatous forbs, such as asters and goldenrods, have fibrous root systems that compete with grasses for water and nutrients. However, taprooted forbs, such as scurf pea and false bonaset, have extensive root systems that extract water from deeper soil horizons than grasses.

Forbs can actually benefit grass production by modifying the microclimate. By providing shade and shelter from the wind, forbs reduce evaporation and temperature of nearby grass plants, which increases water use efficiency. In Kansas mixed-grass prairie, blue grama and buffalograss yields are increased if western ragweed is present in amounts up to 1,200 pounds per acre.

Weeds are pioneer species in the succession of disturbed sites. Annual weeds can respond rapidly to fluctuations in temperature and moisture and are more opportunistic than perennials. Low precipitation and above normal temperatures in the spring produce favorable conditions for warm-season annual weeds (e.g., green and yellow bristlegrass). Disturbed sites, heavily grazed pastures, and bare areas caused by spot grazing are particularly susceptible to annual weed invasion whenever a wet spring follows a dry year.

Some weeds may not directly reduce herbage production but can adversely affect livestock performance. Dense weed stands interfere with grazing and hinder livestock travel through the area. Weeds with spiny leaves, awned seeds, or a pungent odor discourages grazing of nearby forage.

### Wildlife Habitat

A balance of grasses, forbs, and woody plants increases habitat diversity and benefits wildlife. Edge, the boundary between different vegetation types, also is important in providing food, protection, and space for wildlife. As a rule, good grazing management benefits wildlife.

Many forb species provide forage for wildlife and are important in attracting and maintaining wildlife populations. Forb seeds, such as sunflower and ragweed, have higher energy content than wheat and sorghum and are valuable food sources for many birds.

### Control Methods

Controlling unwanted plants can be expensive and difficult. Poisonous, noxious, and invading weeds that are not compatible with range forage should be targeted for control. Many "weeds" are actually beneficial to livestock and wildlife, and the consequences of their removal should be considered before a control program begins. Because species respond differently to control attempts, accurate identification of the undesirable weed is important for successful management.

Forage production decreases as weed encroachment increases, and at some level, weed populations become high enough to warrant control. To be justified, control of undesirable species must increase forage production or availability for livestock. Reducing unwanted plants to a tolerable level generally is more economical than attempting to eliminate them. Cost effectiveness increases when weeds are controlled on sites with high production potential, such as lowlands and meadows.

### Grazing Management

Grazing management is the most economical way to manage weeds. Livestock will graze many weeds early in the growing season. Continuous, moderate stocking allows cattle to select weeds and cool-season grasses that are growing before the warm-season perennial grasses emerge. Because their growing points are exposed, forbs are weakened more than grasses by repeated grazing.

The competitive ability of warm-season perennial grasses is improved if rangeland is periodically rested during the last half of the growing season. For yearling cattle operations, intensive stocking in the first half of the growing season and then resting the pasture from grazing can effectively reduce many weed species and improve range condition. The absence of late-season grazing supplies abundant fuel for burning the following spring. Additionally, an overwintering mulch layer protects the soil and provides an environment that is unfavorable for the establishment of annual weeds.

Selective grazing by different kinds of animals also can affect weed populations. Livestock and wildlife species prefer different types of forage. Horses eat very few forbs and their intense grazing pressure on grasses favors weed establishment. Sheep eat less grass and more forbs than cattle and will consume many forb species that are unpalatable to cattle. Deer and goats primarily consume forbs and browse and generally do not compete with cattle for forage. In some areas of the state, however, high deer populations have reduced forage normally available for cattle.

### Prescribed Burning

Fire played an important role in the development of the Great Plains grasslands. Prescribed burning is a valuable tool for managing weed and grass populations in the tallgrass prairie. Most annual weeds and grasses and many undesirable perennial forbs can be controlled with fire.

The response of forbs to fire depends upon the timing of the burn. Prescribed burning in late spring when the forbs are actively growing is the best time to control most forbs. Burning in early spring increases perennial forbs but generally reduces warm-season grass production. Prairie three awn is unique because it must be burned in November to be controlled. Biennial weeds that are in the rosette stage are not controlled

by fire. Fire should be used with caution in western Kansas because soil moisture loss may reduce forage production.

### Mechanical Control

Mechanical controls, such as hoeing and grubbing, are effective but are labor intensive and expensive. Consequently, mechanical control measures are only feasible for small or scattered patches. Oftentimes, grubbing initial invading weeds can prevent severe infestations. If taprooted weeds, such as musk thistle, are dug, the root must be cut several inches below ground level to prevent regrowth.

Mowing weed infested areas temporarily removes top growth but often stimulates vigorous regrowth. Because desirable forage is also clipped, mowing should be limited to dense weed stands. Undesirable annual grasses should be mowed after the seed stalk has elongated but before seeds mature. Annual forbs can be controlled by cutting below the lowest leaf early in the growing season. Annual forbs also may be mowed before seed formation, but many species become woody at maturity and remnant stems can injure livestock feet. Mowing may be aesthetically satisfying, but it seldom eliminates annual weeds because viable seed in the soil and dispersal from surrounding areas continually invade. Mowing generally is not effective in controlling perennial forbs, although repeated mowings will reduce their vigor and limit their spread.

### Herbicides

Applications of 2,4-D and other herbicides have reduced forb populations on many grasslands. Removing all forbs from rangeland with indiscriminate spraying, however, is not desirable. Elimination or large-scale reduction of beneficial forbs will reduce animal gains, disrupt wildlife habitat, and produce a plant community that has a shortened season of high-quality forage.

Herbicides are most effective on annual weeds that are in the seedling stage or less than 8 inches tall. Biennial species require two years to complete their life cycle and are easiest to control when they are in the rosette stage. Perennial weeds are most susceptible to herbicides during the bud to early-bloom stage. Optimum weed control is obtained if conditions that are favorable for plant growth follow the herbicide application. Careful and selective use of herbicides, combined with proper management, can hasten recovery of weed-infested areas. Apply only herbicides that are labeled for the target weed species and registered for use on rangeland. Application equipment should be accurately calibrated to obtain maximum weed control and prevent environmental damage.

Follow label instructions carefully and use herbicides with caution. Consult your county Extension office for the latest recommended chemicals.

## Summary

Weed management is an important factor in properly managing rangeland. Determining whether or not a “weed” is detrimental is the first step of a control program. Weed infestations are often the symptom of underlying problems, and unless the problem is corrected, weeds will continually recur. The key to weed management is recognizing potential problems and controlling them before they become serious.

## Rangeland Brush Management

Brush infestations compete with desirable forage for moisture, light, and nutrients and can be a major limitation to rangeland production. Dense brush stands obstruct grazing, reduce livestock performance, and interfere with livestock handling. Removing trees and brush from rangeland can increase forage production and livestock carrying capacity.

Eliminating all woody plants, however, is not always practical, necessary, or desirable. Isolated trees provide shade for livestock and can improve grazing distribution. Trees and shrubs shelter livestock from wind and snow, furnish suitable areas for calving, and provide wildlife habitat. Clearing woody plants along streams and ravines can increase soil erosion, reduce water quality, and may increase total carrying capacity only slightly.

Woody plants can increase wildlife habitat diversity. Many wildlife species utilize woody sites for food, cover, and protection. Because of the potential aesthetic, economic, and recreational value of wildlife, scattered stands of woody plants can be compatible with livestock production.

Historically, woody plants were confined to areas along creeks, streams, and rivers where soil moisture was high (riparian sites). Woody plant invasion into the prairie was controlled by three factors: 1) recurrent fires, 2) continuous grazing pressure from numerous herbivores, and 3) periodic drought. Lack of burning and replacing native herbivores with domestic livestock contributed to brush species encroaching into grazinglands.

## Management Decisions

Brush invasions are frequently ignored until the problem becomes severe. Once established, control is difficult and expensive, and the cost of attempting to eradicate a species usually exceeds any benefits gained. The decision to treat brush infestations must balance the expected value of potential benefits with the cost of control.

Depending on management objectives, leaving some brush areas for wildlife may be more economically feasible than trying to reclaim the land for grazing. On grazing areas that have the potential to produce economic returns, undesirable woody plants should be reduced to tolerable levels and then managed to prevent further encroachment.

## Brush Control Methods

Because woody species differ in their response to control attempts, accurate identification of the target plant is important for successful management. Selecting the proper control method depends on the plant species, size of the infestation, topography, economics, and management objectives. Combinations of different control methods are often less costly and more effective than a single method.

## Prescribed Burning

Prescribed burning is one of the most important practices for managing brush, especially in the eastern half of Kansas. In the absence of fire, woody species progressively invade and will eventually dominate tallgrass prairie. Mulch provides favorable conditions for the germination of many woody species, particularly when a wet spring follows a dry year.

Effective control of woody plants with fire depends upon the species, amount of fuel, when the burn occurs, and how frequently it is burned. Nonsprouting species, such as eastern red cedar, are readily killed by a single burn if they are less than 5 feet tall and adequate fuel is available. Resprouting species, however, require two or three consecutive years of prescribed burning at the proper time for successful control.

The best time to control most brush species with fire is when the plant reaches its low point in food reserves. That normally occurs in mid- to late-April when the dominant warm-season perennial grasses (e.g., big bluestem and Indiangrass) are 1 to 2 inches tall. Smooth sumac and leadplant, however, have different root reserve cycles and are not harmed by late-spring burning.

Successful control of woody species with prescribed burning increases if there is abundant fuel and environmental conditions are favorable for a hot fire. Headfires pushed by a 10 to 15 mph wind are necessary to damage large trees. Dense brush stands may require an initial treatment with herbicides before fire can carry through the area. Resprouting brush can then be suppressed with a systematic burning program. Integration of prescribed burning followed by foliar application of herbicides on the regrowth can improve control of difficult species, such as roughleaf dogwood.

## Mechanical

Mechanical brush control is labor intensive, expensive, and generally feasible only for small or scattered patches. Nonsprouting trees can be killed any time if they are cut at ground level. Resprouting species, however, need to be cut when their root reserves are low. Mowing in late-April will control woody plants, such as buckbrush, but smooth sumac must be cut in early June.

Two or three consecutive years of cutting at the proper time is required to kill most woody species. Resprouting of

some trees, such as hedge and honey locust, can be prevented by applying a herbicide to the stump immediately after cutting.

Dense stands of trees or brush can be cleared by bulldozing; however, surviving roots may resprout. Bulldozing also destroys desirable plant species, and reseeding is usually necessary to prevent erosion. Cleared debris stacked in brush piles provides cover for wildlife.

## Herbicides

Most woody plants are susceptible to properly applied herbicides. Herbicide effectiveness depends upon using the proper chemical at the correct time and rate. Each brush species has a period when it is most susceptible. Environmental factors, such as precipitation, temperature, and wind, also affect herbicide activity.

Herbicides can be applied by several methods but those used in combination with mechanical methods are feasible only for scattered patches.

*Broadcast spray:* Foliar herbicides may be applied either with ground equipment or aircraft. Ground equipment sprays are suited for individual plants or scattered brush stands, but aerial applications are necessary for dense stands, large areas of infestation or rugged terrain.

Timing is critical for successful brush control. Normally, foliar herbicides are applied in the spring after the leaves have fully expanded, and the plant is actively growing. Different woody species, however, may have different periods when they are most susceptible. To be effective, foliar herbicides must be absorbed and translocated by the plant. Consequently, optimum control requires completely wetting the leaves and favorable growing conditions.

*Soil Applied:* Applying pellet, granular, or liquid herbicides to the soil surface in a grid pattern or evenly spaced under the drip line controls many brush species. Treatment should be timed to coincide with anticipated rainfall in early- to late-spring. **Soil applied herbicides should not be applied when the soil is frozen or saturated with water. Herbicide uptake from the roots of nearby vegetation is possible.**

*Basal bark:* Applying a mixture of herbicide and diesel oil to the lower portion of the trunk will control many species. Large trees or species with thick bark may not be susceptible to this treatment. The entire circumference of the trunk should be soaked up to 18 inches above ground until runoff. Basal bark sprays are most successful from mid-July to mid-January. The solution should not be applied when the bark is wet or when the temperature is below freezing.

*Girdle or Frill:* For trees larger than 5 inches in diameter, grooves or notches can be cut in the trunk. Herbicides applied to the cuts will penetrate the sapwood and control most species.

*Cut stump:* Cutting the woody species at ground level and then immediately applying the proper herbicide to the

cut surface will usually prevent resprouting. It is most successful between mid-July and mid-January.

Herbicides should not be applied unless registered for use on the site and the target brush species. Application equipment should be accurately calibrated to obtain maximum brush control and prevent environmental damage.

**Follow label instructions carefully and use herbicides with caution. Consult a county Extension office for the latest herbicide recommendations.**

## Grazing Management

Woody plant seedlings and sprouts are stunted by livestock browsing in moderately or heavily stocked pastures. Consequently, woody plants seem to spontaneously appear if livestock are removed from heavily grazed range. Except for occasional variety in diet, cattle normally do not eat mature woody plants. An exception is yucca, which can be controlled in western Kansas with continuous grazing by dry cows during the winter.

Deer and goats consume large amounts of browse. Sprout regrowth is nutritionally high quality and easily accessible to browsing. Despite differences in forage preferences, increasing deer populations in some areas of the state may reduce forage availability for livestock grazing.

## Which Method is Best?

Choosing an application method is determined by the brush species, its size, and the type of herbicide. Treatments that are integrated with mechanical methods, such as cutting or girdling, are time consuming and only practical for individual trees or small infestations. Mixed brush species often are not controlled by the same herbicide, and a combination of control methods may be required to reduce the infestation to manageable levels. Prescribed burning is an effective follow-up treatment to chemical control; however, the area should not be burned the same season that translocated herbicides are applied.

## Summary

Brush management is an important factor in properly managing rangeland. The key to brush management is recognizing potential problems and controlling them before they become severe. Once brush infestations are reduced to tolerable levels, good grazing and pasture management can limit recurrence.

## Water Developments

Water is a nutrient as well as a grazing management tool. Water is the most important but often overlooked nutrient or management tool. It is also critical in the more intensive grazing management options. Lack of water, poor

quality water, or poorly placed watering facilities are the usual problems encountered. The following are brief discussions of the options available with emphasis given to improvements or new technology.

### Windmills

Windmills have been in use for over a century. The basic design has changed little. A revival in their use has occurred in the last 15 years, but high installation costs and maintenance have limited their acceptance.

### Ponds

Ponds have been used for impounding and storing water since man began moving earth. Two basic designs have been used: stock ponds and pit ponds. Both have advantages and disadvantages. Any open water is a potential hazard in the winter since cattle will walk on the ice and can fall through and drown.

Stock Ponds have been extremely effective in areas where the subsoil strata can be sealed. Properly built and protected, they will supply water for livestock, wildlife, fishing (if stocked), and provide recreational opportunities. Construction costs have increased rapidly in recent years making them expensive investments. They also suffer from sedimentation when runoff is from nearby cropland without proper conservation practices.

Pit Ponds are small excavations, usually in stream beds, drainages, or areas with water at or near the surface. A "pit" is dug with at least one side with a gentle slope (3:1 or 4:1 slope). The soil removed may be piled to one side or used to build a low dam around the pit.

### Pipelines

While not new, recent improvements in pipe, pumps, and troughs have opened new avenues for their use. Improved materials, more energy efficient pumps, and redesigned troughs have allowed simpler and less costly pipeline systems to be installed.

Pipe and pumps used today are similar to those used for domestic use. Ease of handling, efficiency in operation, and durability, without major cost increase are the main improvements.

Troughs have been improved to make them more durable and/or to reduce storage requirements. To reduce freeze damage, some concrete troughs have sloped inside walls. Large diameters (over 20 feet) allow the trough to be used for storage as well.

#### • Advantages:

1. To place water at the best locations to benefit the management of the grazingland, grazing, and animal performance.
2. Allow for adequate water supply where wells, ponds, and other water sources are not possible.
3. Allow multiple waterings from one water source.

#### • Disadvantages:

1. Requires initial cost outlay to install.

2. Increased maintenance of the system may be necessary compared to other possible options.

### Solar-Powered Pumps

This new adaptation of solar panels for powering low-volume pumps is being used to raise water 20 feet or more in areas where electricity is not available or where windmills are not cost effective. The combination of the solar panels and low-volume pumps gives many ranchers new opportunities to better utilize grazingland.

The pumping unit is constructed of a corrugated steel culvert tube with the pump mounted inside near the top. The unit is buried vertically in the ground, allowing the water to rise inside. The solar panel is mounted above the unit to either charge a battery or power the pump directly. The unit can be ordered for continuous or controlled flow.

#### • Advantages:

1. Allows the use of water strata where topography does not permit gravity flow, and other power sources are not practical.
2. Allows development of "seeps" or "wet spots" for livestock water.
3. Controlled-flow design allows efficient use of limited water.
4. Solar panel and pump can be used in more than one location to reduce cost.

#### • Disadvantages:

1. Requires regular maintenance to ensure operation.
2. Limited volume.

Major distributor (contact for local dealers): Solapumps, Inc., 100 South First, WaKeeney, Kansas, (913) 743-2360.

### Spring Developments

New developments in pipe and troughs have made spring development a better option in some areas. Many times livestock water can be developed in locations that are "problem wet" areas. Interrupting a spring or wet area with a collector system and piping it to a trough(s) provides clean water under controlled conditions. With the use of gravity flow pipeline, troughs may be some distance from the spring.

#### • Advantages:

1. Develop livestock water from limited water sources.
2. Provide clean water from wet, muddy areas.
3. With a flow of 1 to 2 gallons per minute, water seldom freezes almost eliminating chopping of ice.
4. Relatively low cost, low maintenance water development.

#### • Disadvantages:

1. Site availability may limit development.
2. Some sites may be difficult to develop without increased costs.
3. Development will require digging, resulting in bare ground that may need erosion protection.
4. Volume and dependability of water flow may not be accurately determined before beginning development.

## ***Fencing***

Adequate fencing is required to manage the grazing resource. Manipulation of the grazing animal to benefit the plants and to effectively harvest the forage are the primary goals. Without adequate control, livestock will graze the most palatable plants first, leaving less palatable ones until later in the season or ignoring them altogether. Uniform utilization of the forage on a timely basis can improve animal performance and production while improving the grazingland resource.

### **High-Tensile Steel Wire**

High-tensile steel wire has an old reputation to live down. Historically, this wire was difficult to splice, hard to keep tight, kinked easily, and broke when kinked. Today's wire has been vastly improved. Compression splicing sleeves, special tighteners to maintain the tension, and other options make it a management tool to consider. The wire is a 12½ gauge, Class III galvanized wire, with a tensile strength of at least 110,000 pounds per square inch and a breaking strength of at least 1,100 pounds. Design of the fence should consider location, legal requirements, and adequacy of fence to control animals.

- Advantages:

1. No barbs.
2. Lower cost.
3. Repairs may be reduced.

- Disadvantages:

1. Requires stronger braces to maintain wire tension.
2. Maintenance may be increased to maintain wire tension.
3. Usually requires more wires to control animals.
4. Acceptance may be difficult due to local traditions and state laws.

### **High Energy—Low Impedance Fencing**

The heart of these electric fence systems is the solid state “energizer” that charges the high-tensile steel wire. Developed in Australia and New Zealand, they were first brought to the U.S. for predator fencing. They have become a low-cost option to permanent barbed or netting wire for cross fencing. State law may limit their use for boundary fences.

Electric fences provide a “mental” barrier to livestock rather than the “physical” barrier provided by a barbed wire fence. Two wires (high tensile steel wire) are a minimum for providing reliable fencing. Spacing and height above the ground will vary with the livestock and/or wildlife being controlled. Brace and stretch posts must be better than conventional fences to maintain the 150 to 200 pounds stretch needed. Line posts can be of several materials, but self-insulating posts (primarily fiberglass) are desirable. Power for the energizer can be from batteries, solar panels, or 110/120 volt.

Grounding of the energizer and fence are critical to its power operation. Fences operate most effectively at 3000 volts or higher for cattle.

- Advantages:

1. Lower cost.
2. Effective livestock control when properly designed, installed and maintained.
3. Can be designed for predator and wildlife control.
4. Fencing over uneven terrain (especially streams and other depressions) can be simpler.

- Disadvantages:

1. Tradition—acceptance by ranchers and others.
2. Higher voltage (3,000 volts or higher) results in a highly unpleasant shock to people. (Electric fence warning signs along fence are highly recommended).
3. Prolonged contact with the fence (entrapped on the fence) may have serious health hazards.
4. Durability of fencing materials is unclear when pre-scribed burning is practiced.
5. Extra bracing needed in rough topography.

### **Major Distributors (contact for local dealers)**

Gallagher Snell Power Fencing Systems, Snell Systems, Inc., P.O. Box 17769, San Antonio, TX 78217, 800-531-5908

Parker McCrory Manufacturing Co., 2000 Forest Ave., Kansas City, MO 64108, 816-221-2000

Pel Electric Fence Systems, Twin Mountain Supply Co. Inc., P.O. Box 2240, San Angelo, TX 76902, 800-331-0044

Shock Tactics Electric Fence, Waterford Corporation, Box 1513, Fort Collins, CO 80522, 800-525-4952

Speedrite Fencers, Grassland Supply, R.R. 3, Box 48, Council Grove, KS 66846, 316-767-5487

## ***Facilities and Equipment***

Handling livestock, making and feeding hay or silage, and many other practices or jobs need to be done regularly. Having the right equipment, in good repair, and in the right place is a part of good management. Good corrals, a squeeze chute, scales, and similar equipment allow you to work livestock as needed. Timely working of livestock, in a quiet manner, will reduce stress and let the animals perform at their optimum.

## ***Supplemental Feed***

Livestock production is a year-round enterprise for most producers. Under Kansas conditions, at least some period of time during the year will require feeding in addition to grazing.

Supplemental feed should complement use of native range. The goal is to optimize utilization of native grass while meeting the animals nutritional needs. Factors to



consider include age and condition of cattle, stage of production, and nutrient deficiencies in the forage. For range cows, the two most critical periods for supplementation are the 50 days before calving and the 80 days postcalving. Nutrient deficiencies at these times greatly influence conception rate and calf weaning weight. Two types of supplemental feeding are usually considered: to supplement normal nutritional needs and to supplement under emergency conditions. Both need to be considered in planning.

Dormant forages, mature forages, and stockpiled forages can readily supply dry matter to animals but may be of low quality. Supplemental feed can be purchased or raised. Protein sources such as soybean meal, grain cubes, or grain are concentrated forms. High-quality hay (alfalfa, brome, prairie, etc.) can also be used.

### *Emergency feed*

Feeding to meet animal needs due to drought, snow, extreme cold, or extended wet periods must be considered in planning. Meeting the nutritional needs (protein, energy, minerals, etc.) is the first consideration.

Knowing the quality of both the grazed forages and the supplements available and balancing the diet is a must to remain profitable. Supplementing the nutrients available in the forage to meet the animal's needs can be cost effective. Over feeding is usually expensive and wasteful.

### *Kinds of Grazing Systems*

Grazing systems are a specialization of grazing management which plans and implements systematically recurring periods of grazing and rest. Grazing systems have become popular in the past 20 years. There are many different kinds, and each has advantages, disadvantages, and limitations. Designing and implementing a grazing system is more than just moving livestock from pasture to pasture. Designing the system requires a knowledge of the resources (land, labor and capital), kind of livestock and their management, managerial ability of the operator, and the management goals of the owner/operator. Careful attention to details of physical developments (water, fencing, etc.), timely decision making, and financial considerations are major concerns.

The following are several categories of grazing systems in use today. As the complexity of the system increases, the level or intensity of the management must also increase. Many can save on labor (time) but will require more management (time) instead. Some will benefit the plant, the animal, or both. Some are known by several other names.

Sequential or complementary forage grazing systems (using two or more forages during the grazing season) is a rather recent (last 30 years) innovation. Combinations of forages are being used in sequence by more producers every year. The basic goal is to provide green, high-quality forage for the longest feasible period of the year. Normally,

producers design a system to graze the forage at its highest quality whenever possible. Properly designed and managed, these systems benefit both the plant and the animal.

Sequential forage systems are those where two or more forages are grazed in a sequence. To properly design a sequential forage grazing system, forages must have different growing seasons and fenced separately. Each forage is used during its vegetative growth period. Regrowth may be stockpiled for dormant season use. When changing forages, one must ensure the nutritional level of the animal does not have major changes. Some examples of sequential forage systems include:

*Cow/calf:* Calve on stock-piled grass until mid- to late-April. Move to smooth brome or tall fescue until mid- to late-May. Move to rangeland for summer. If available, wean calves to cool-season pasture and move cows to crop residue. If summer annual forages are available, calves can be "creep grazed" on them.

*Stockers:* Buy light cattle in late winter and background on stock-piled grass with supplementation. Graze smooth brome or tall fescue from late-April to mid-May. Move to rangeland and sell cattle when ready for market. The emphasis is on producing a marketable animal at the least cost.

Complementary forage systems are those which use two or more forages together. The second forage is used to 'supplement' the first or major forage. Generally, the second forage is an annual, such as sudan, wheat, or triticale. The second forage is grazed at the same time as the primary forage to add quality to the animals diet. As with sequential forage systems, when changing forages, one must ensure the nutritional level of the animal does not have major changes. An example of a complementary forage is the use of a summer annual and a cereal with rangeland with a cow/calf operation.

Intensive early stocking, used only on rangeland, is an example of part-season grazing. Doubling the number of stockers during the first half of the grazing season (May 1 to July 15) has benefitted both forage and livestock production. Once grazed during the early part of the season, livestock must not graze the pasture again until after the plants are dormant. Variations of the concept are being used on rangeland.

Deferred grazing is the use of deferment in a management unit but not in a systematic rotation including other units. It is the practice of reserving a pasture to use during the dormant season or to supply dry matter during a critical part of the year. The major disadvantage is low-quality forage. The advantages include cheaper forage than harvested forage. It can usually meet the needs of cows in mid-gestation and can provide protection for calving. Pastures used during the dormant season and rested through the growing season are usually in the best condition. Unless adequately supplemented, animal performance may be reduced.

Two to four pastures-one-herd systems, often called "rotation grazing," require livestock be moved from pasture to pasture with each pasture being grazed only once each

year. The next year, grazing begins in a different pasture. To maintain nutritional quality, moves must be made such that animals are not facing major palatability and/or nutritional changes. For a two- or three-pasture program, the first move must occur in mid- to late-June with palatability and quality of the forage being the main criteria. With the three-pasture program, the second move should come in mid-August, based on the same considerations. With four-pasture programs, moves are dictated solely on forage availability, palatability, and quality. These are used mainly on rangeland. Forage potential is usually improved by these systems, but animal performance may be reduced unless careful management of their nutritional needs is maintained.

Rapid rotation systems usually utilize less than six pastures and have relatively short grazing periods in relation to the rest period. Each pasture is grazed two or more times during the season. The length of the grazing period will vary according to the number of animals (grazing demand) and the growth or regrowth of the forage. Moves must be made to ensure the nutrition of the animal. These can be used on rangeland, tame pasture, and irrigated pasture. Properly designed and managed, they benefit both the plant and animal performance.

Cell or time-controlled grazing is an intensification of the rapid rotation. Grazing periods and move dates are strictly on a decision basis. Generally, there are six or more pastures involved. The goal is to utilize the best parts of all the plants and not just the most palatable (really a form of nonselective grazing). Relatively long rest periods follow the grazing period. This is an intensive management program. Research and experience indicate both the plant and animal can benefit if the system is carefully designed, implemented, and managed.

### Designing a Grazing System

A grazing system is more than just moving livestock around. It must be designed to accomplish specific goals and objectives within the resources available (land, labor, capital). Design considerations must include not only the mechanics of the system, but also the animal, marketing, and financial management as well. Above all, the attitude, understanding and ability of the operator is the key.

Three major concerns must be given design consideration: water, fencing, and animal nutrition. Each has points that need to be used in designing a grazing system.

Water for the grazing animals must be adequate, including a reserve in case the source fails. Generally, wells and springs are more reliable than stock ponds and streams. Clean, high-quality water are the major requirements. Consult the discussion, *Water Developments*, earlier in this section.

Fencing is the second consideration. The discussion, *Fencing*, earlier in this section can provide some information.

Animal nutrition is directly related to animal performance. One concern in many grazing systems is the varying

level of nutrition resulting from the movement of animals from grazed to ungrazed forages. Figure 1 shows the nutritional variability that can result from animal movements. Moving animals before non-selective grazing becomes excessive will reduce the effect.

### Other Factors to Consider

Grazing systems should be suited to the kind of plants and soils present. A good grazing system will improve range condition and forage production by favoring desired plants. Changes in species composition and reduction in forage production will occur with systems that do not allow desirable perennial grasses time to replenish their food reserves.

A grazing system should benefit livestock as well as the vegetation. Forage production and animal performance are influenced by the grazing system stocking rate. Individual animal performance should not be sacrificed for high livestock production per acre. The type of livestock operation and managerial ability are important in considering a grazing system.

### Summary

Every operation is unique in its resources, financial situation, and managerial ability. The result is "there is no perfect forage nor grazing system that can be applied universally." Applying the basic management principles through the use of appropriate management practices are a must in designing grazing systems. Above all, managing both the plant and animal systems for long-term, sustained maximum production should be the major goal. Nutrition of the plant and the animal are critical.

## Fertilization Management for Kansas Grazinglands

*Ray E. Lamond*

The grazingland of Kansas is an extremely valuable resource. The states' beef cow-calf enterprise depends entirely, or in part, on the grazingland, and large numbers of grass-fed cattle and calves are marketed in Kansas every year. The grazingland of Kansas is nearly as diverse as it is important. Kansas rangelands evolved under varied climates, with extremes in temperature and precipitation just like we have today. Kansas rangeland can vary from simple to complex mixtures of perennial grasses and forbs with some native annuals and biennials. The introduction of tame grasses has added a permanent and important component to the Kansas grazing resource. The diversity of Kansas' 20 million acres of grazingland is obvious. This diversity (not only in plant species, but in climatic conditions) makes general grazingland fertilization management strategies

difficult at best. To simplify things, the strategies discussed are separated into warm season and introduced grazingland.

**Warm-Season (Native) Rangeland**

Warm-season rangeland can produce a fairly high-quality forage, particularly early in the growing season, and utilization of this forage results in significant removal of nutrients—especially nitrogen, phosphorus, and potassium. For example, a native range that produces 4,000 pounds of forage per acre that averages 7.5 percent crude protein would remove about 50 pounds of nitrogen. While this represents a significant nitrogen requirement, native rangeland soils are often high in organic matter—an excellent source of nitrogen. In many cases, enough nitrogen is released from organic matter to meet the needs of the warm-season rangeland grasses. However, research conducted on nitrogen fertilization of native rangeland has indicated that applying 40 pounds of nitrogen per acre in late April to early May can increase forage yields, increase carrying capacity, and increase beef production per acre. This work was done on both tallgrass (big bluestem, switchgrass, indiangrass) and short-grass (western wheat-grass, buffalograss, blue grama) range. In the tallgrass range, nitrogen fertilization was most efficient when coupled with late spring burning. In fact, nitrogen fertilized tallgrass range had to be burned in late spring to prevent shifts to undesirable plant species.

While native range can respond to nitrogen fertilization, the profitability of the operation is highly dependent on market prices of livestock and fertilizer. Research indicates that applications of more than 40 pounds of nitrogen per acre are uneconomical and cause undesirable shifts in vegetation. Stocking rates should be increased to take advantage of increased forage production and palatability when nitrogen is applied, particularly early in the growing season.

In most cases, Kansas rangeland soils can supply adequate amounts of phosphorus, potassium, and other nutrients to meet the needs of established warm-season grasses.

A significant acreage of native grass has been seeded in recent years due to farming as a result of the Food Security

Act of 1985. Fertilization management for seeding and establishment should be a consideration. Soil testing prior to seeding is recommended. Guidelines for seeding and establishment are found in Table 2.

**Permanent Introduced Grasses**

Considerable acreage of permanent introduced grass exists in Kansas, mostly in the eastern one-half of the state. The primary cool-season grasses are either smooth brome-grass and/or tall fescue. These cool-season grass grazinglands can provide high-quality forage, particularly in early spring through early summer and again in the fall.

**Cool-Season Tame Pastures**

Cool-season grasses require more fertilizer than the warm-season grasses. In fact, nitrogen fertilization is an essential part of a successful management program for cool-season grasses. For example, well-managed brome can produce from 3 to 5 tons of forage per acre and average from 10 to 14 percent crude protein over the growing season. A 3 ton per acre brome yield at 10 percent crude protein would require about 100 pounds of nitrogen per acre.

The optimum nitrogen rate to use depends on how the cool-season grazingland is managed, and when forage is utilized in both fall and spring, a split application of nitrogen (1/3 in August, 2/3 of total N applied in December—February) will likely be beneficial.

Cool-season grasses can also respond to phosphorus. In fact on soils testing low in available phosphorus, nitrogen applications are ineffective unless phosphorus is supplied also. Soil test phosphorus levels and forage production levels determine how much phosphorus to apply.

Most Kansas soils supply enough potassium to meet forage needs; however, in southeast Kansas potassium applications could be economical. Use soil test levels as a guide.

Prior to seeding and establishment of cool-season permanent pasture, soil test and make corrective additions of lime, phosphorus, and potassium, if needed. Once the grasses are established, lime applications are not very

**Table 2. Fertilizer recommendations for native grass seeding.**

Soil Test Level		Recommendation
pH	P	
6.0–8.0	all levels	no lime or phosphorus needed
<6.0	all levels	add lime according to soil test recommendations (if available)
<6.0	<10	if lime is not available, apply minimum of 20 pounds of P <sub>2</sub> O <sub>5</sub> per acre
<6.0	10–20	if lime is not available, apply minimum of 10 pounds of P <sub>2</sub> O <sub>5</sub> per acre
<6.0	>20	no P is needed
8.0>	all levels	determine if soil is calcareous and/or saline, no phosphorus needed; if saline, select proper grass species

efficient since incorporation is not possible. Applications of relatively small amounts lime, however, may be useful in increasing stand longevity.

### ***Warm-Season Tame Pastures***

Kansas also has a significant acreage of the warm-season grass—bermudagrass. This introduced species is found mostly in the southeast part of the state but has been successfully grown as far north as the Salina area. Bermudagrass can produce large forage yields, particularly if multiple cuttings or heavy grazing programs are used. With the large yield potential comes a heavy demand for nitrogen.

Bermudagrass can utilize 200 pounds of nitrogen per acre or more under intense management. Actual nitrogen rate used depends on how bermudagrass is managed. Where multiple cuttings are taken, or if rotational grazing systems are used, split nitrogen applications are advisable, with additional nitrogen applied after each cutting or grazing period. Phosphorus and potassium should be applied according to soil test. In southeast Kansas, where some low potassium soils occur, be sure to include potassium if soil tests indicate a need. Potassium is important in the winter hardiness of bermudagrass. If lime is needed, it should be applied and incorporated prior to sprigging.

### ***Annual Forages***

A growing part of the Kansas grazingland acreage statewide are summer annual forages, including sudangrass, sorghum-sudan hybrids, the millets, and the cereals, including wheat, barley, oats, and triticale. By using both summer and winter annuals or spring-planted cereals, a year-round supply of forage to supplement permanent grazing land can be obtained. These grasses can be utilized for grazing, hay, and silage, or greenchop. Annual forages respond to nitrogen as excellent yields are obtainable with favorable climatic conditions. A profile nitrogen soil test is recommended to avoid overfertilization with nitrogen since nitrate accumulation is possible in many of the summer annual species when stress conditions occur. Where multiple cuttings or rotational grazing is used, split nitrogen applications are advisable. Apply lime, phosphorus, and potassium as indicated by soil test.

## **Stocking Rate and Management**

*Paul D. Ohlenbusch and Steve L. Watson*

Grazing management relies on several principles and practices to maintain and improve the productivity of the grazingland resources. The understanding of the effect of the principles and practices on the performance of the resources and the ultimate profitability of the operation is the key.

### ***Stocking Rate***

Stocking rate is defined as the land area allocated to each grazing animal for the grazable period. Stocking rate determines:

- How well the plant can recover from grazing during the growing season,
- How well the plant will continue to produce in succeeding years, and
- The quality of the available forage. The leaves are the highest quality parts of the plant for animal grazing.

Many livestock operations base their stocking rate on tradition, the rate used by their neighbors, financial pressure, research results, or guesses. For grazed forages to remain productive, grazing pressure must be matched to the pasture's carrying capacity on a case-by-case basis.

Grazing pressure is the actual demand placed on the forage in relation to the forage supply. Grazing pressure changes as the mix of grazing animals (domestic livestock and wildlife) and their physiological stage, plus the availability of forage.

Carrying capacity is the actual amount of forage the grazingland is capable of producing for harvest. Carrying capacity between pastures can vary for many reasons. Carrying capacity depends on the soil characteristics (depth, slope, etc.); extent of unproductive areas (due to rocks, brush, unpalatable species, etc.); and current forage, weather, and animal conditions.

Matching grazing pressure and carrying capacity will not maximize either animal production or forage production. The goal is to devise a management system that will allow both to become as productive as possible over the long-term.

Figure 5 relates animal production to stocking rate as defined by research (Hart, 1992). These data and long-term research in Great Plains states indicates that a moderate grazing intensity will result in the best long-term economic gain. A manager's goal should be to stock at the average but be prepared to change stocking rate, remove livestock, or plan to feed during periods of drought or other stress situations.

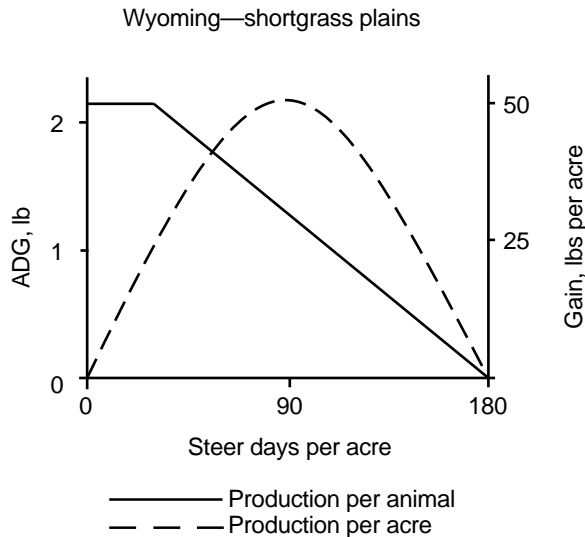

Figure 5. The relationship of animal production to stocking rate based on research on different forage types.

Hart (1992) not only developed the Wyoming stocking rate relationship but also an economic relationship (Figure 6). Maximum profit occurs midway between the maximum production per acre and the break point of animal performance.

### Uniform Utilization

Grazing animals will usually not graze an area uniformly, if left to their own. When this occurs, forage availability and quality will suffer, resulting in reduced animal performance. Uneven grazing patterns can occur for several reasons:

- *Pasture shape, terrain, and water location.* Steep slopes and long distances to water in relation to terrain will often result in underused areas within a pasture. The shape of a pasture can also affect how uniformly it will be grazed. For example, in a large “L” shaped pasture with the water in one end, the end farthest from water will usually be in higher condition because of reduced grazing. Utilizing these underused areas is often difficult and requires changing the grazing animal’s habits and patterns

- *Species preference.* The relative palatability of a plant species depends on factors such as the other species present, stage of growth, and fertility. Grazing animals will concentrate in areas where the plants are most palatable. Certain species, such as eastern gramagrass, big bluestem, Indiangrass, little bluestem, and sideoats grama, will always be the first grazed. Switchgrass, blue gramagrass, and buffalograss will be grazed the least when the more palatable species are present. Western wheatgrass is palatable in the early spring but rarely grazed during late spring and summer. In the fall, new growth again makes it palatable. Some plants are palatable only when planted and managed

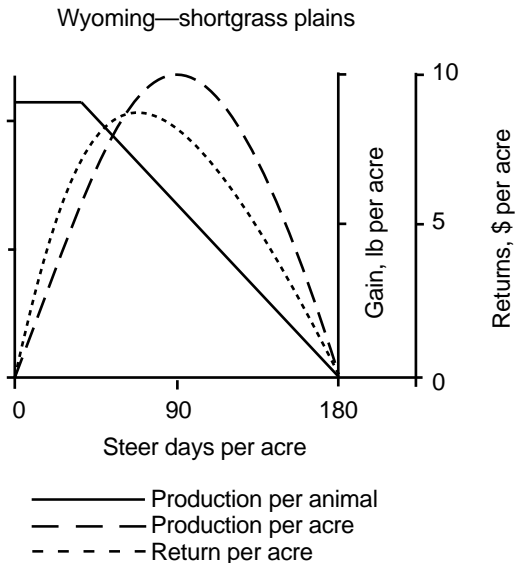

Figure 6. Economic returns maximize midway between the peak production per acre and the point that animal performance begins to decline.

as a pure stand. Examples would be the old world bluestems, tall fescue, sand dropseed, and tall dropseed. Forbs (broadleaf plants) and browse (woody plants) also vary in palatability. Examples of highly palatable forbs are partridge pea and Illinois bundle flower, while leadplant and Russian olive are examples of browse.

- *Seasonal nutritional needs.* Forbs often fill nutritional needs during certain periods. Western ragweed is utilized in late spring and early summer. Grass is high in quality during this period but has an excessive water content. The ragweed is consumed to balance the dry matter requirements of the animal. Shrubs, such as leadplant and Russian olive, are also utilized seasonally.

Many options are available to help encourage more uniform grazing patterns, such as salt/mineral movement, water developments, prescribed burning, and cross fencing. A more complete discussion of the management options is found in KSU Extension publication MF-515, “Grazing Distribution.”

### Degree of Utilization

Only the palatable species should be considered in determining stocking rates. If stocking rates are determined by including unpalatable species as part of the total forage production, continued overuse of the most palatable species will occur.

In determining how much forage the palatable plant species can produce for animal production, three factors should be considered.

1. How much of the herbage should be remaining when the animals are removed. This is the major consideration. No more than 50 percent of the current season’s growth

should be removed during the growing season. To maintain 50 percent of the leaf area, 65 to 75 percent of the current season's leaf length can be removed. Season of use, length of the grazing period, time available for regrowth after grazing (if any), condition of the grazed plants, and current weather conditions influence this decision.

2. How much of the herbage is expected to be lost during the season due to trampling, insects, leaf drop, disease, and wildlife. These are natural and competing losses that must be considered in the determination of utilization. Normally, 25 percent of the current year's forage is considered lost through natural processes.

3. How much of the herbage produced will be available for harvest by livestock. Season of use and nutrient contents of the forage are major considerations in animal performance.

Some recent work suggests that the percentage of the forage actually harvested changes with the type of grazing method used. If these relationships prove to be real and animal performance can be maintained at or near season-long grazing values, increased harvest efficiency will result. The more intensive rotation systems are normally used on irrigated or tame pastures. Their use on rangeland is recommended only when the manager commits to the higher management level required.

### Season of Use

There is an optimal season of use for the plant and for the grazing animal. From the plant's viewpoint, heavy defoliation (grazing) during certain periods is harmful. For warm-season plants, this period is during early vegetative growth and again from late July to frost. For cool-season plants it is in early spring and again in the July to August period. The plant *must* have leaves to produce food, both for current growth needs and for stored food reserves.

Heavy grazing reduces root growth by limiting the amount of food the leaves can produce. Each growing season, approximately one-third of the root system must be replaced by new growth due to root pruning, shrink-swell of the soil, and diseases. Under heavy-grazing pressure, this new root growth may stop and existing roots may die back even further.

From the animal's viewpoint, the period of rapid plant growth prior to seed stalk development results in the highest performance. After seed stalk development, forage quality declines. This is true for both warm- and cool-season forages, whether annual or perennial species.

Developing a grazing management strategy that meets both plant and animal needs simultaneously is a challenge. Consideration should be given to using forages that have different growing seasons. Combining a cool-season pasture (smooth brome, tall fescue, wheat, rye, or triticale) with a warm-season pasture (rangeland, bermudagrass, sudangrass, or millet) can be a way to increase carrying capacity and production. A complete economic analysis of the alternatives should always be made *before* beginning the system.

### Kind and Class of Livestock

The kind and class of the livestock used influences stocking rate. Different animals prefer different forages, as shown in Table 3 (Taylor, 1981):

1. Cattle diets consist primarily of grass.
2. Sheep diets contain more forbs than goat and cattle diets and more grass than goat and deer diets.
3. Goat diets contain a large amount of browse compared to cattle and sheep diet and lower amounts of grass.
4. Deer diets contain large amounts of browse and forbs.

**Table 3. The relative proportions of grass, forbs, and browse in the diets of cattle, sheep, and goats.**

Kind of Forage	Cattle	Sheep (percent)	Goats
<b>Grass</b>	60	40	20
<b>Forbs</b>	20	40	30
<b>Browse</b>	20	20	50

Recent research (Taylor, 1981) has shown that "cattle tend to remove the mature grass growth, allowing sheep and goats to readily utilize young green growth. Therefore, cattle have a complementary rather than a competitive effect with deer when compared to sheep and goats."

Because of the differences in dietary preference, it is possible to mix kinds of livestock under certain conditions to increase carrying capacity and production. However, the forage source must have the necessary species population for the animals to meet their dietary preferences. Cattle and sheep will compete if grazed together in a predominately grass pasture. However, they will complement each other if grazed together in a pasture with a high proportion of forbs and browse. Whatever the forage source, grazing cattle and sheep together will place increased management requirements on the operator.

## References

- Blaser, R. E., R. C. Hammes, Jr., J. P. Fontenot, H. T. Bryant, C. E. Polan, D. D. Wolf, F. S. McClaugherty, R. G. Kline, and J. S. Moore. 1986. *Forage-animal management Systems*. Virginia Agricultural Experiment Station Bulletin 86-7. 91 pp.
- Gates, F.C. 1937. *Grasses in Kansas*. Kansas State Board of Agriculture Report, Vol. LV, No. 220-A. 349 p.
- Hart, R. 1992. *Personal Communications*.
- Hoveland, C. S. 1986. *Basics of Grassland Management*, in Ohlenbusch, P. D., editor. 1986. Proceedings of the four state grassland management workshop—warm season grasses: facts and fantasy, July 7- 9, 1986. Kansas State University Extension Agronomy. p 1-10.
- Kothmann, M. M. 1975. *Grazing Management Systems*. Texas Agric. Progress 21:2:22-23 (TAP 726).
- Taylor, C. A. Jr. 1981. *Optimal use of range with mixtures of livestock*. pp. 166.175. In White, L. D. and L. A. Hoermann (eds.). Proceedings of the International Ranchers Roundup, Del Rio, Texas. Texas Agricultural Extension Service, Uvalde, Texas 434 p.
- Tomanek, G.W. 1959. *Effects of Climate and Grazing on Mixed Prairie*. Reprinted from Grasslands, Amer. Assoc. Adv. Sci. pp. 371-377.
- Weaver, J.E. 1954. *North American Prairie*. Johnsen Publishing Co., Lincoln, Nebraska. 348 p.
- Weaver, J.E. and Albertson, F.W. 1956. *Grasslands of the Great Plains—Their Nature and Use*. Johnsen Publishing Co., Lincoln, Nebraska. 395 p.





## Questions for Chapter 16

1. What is the most useful grazing management tool?
2. What are the benefits of prescribed burning?
3. Why does burning stimulate growth of some woody species?
4. Why are some weeds beneficial in rangelands?
5. What are the impacts to the resource caused by stocking rates?
6. What is the difference between carrying capacity and grazing pressure?
7. Is fertilization necessary on native rangeland?

Name \_\_\_\_\_



## Chapter 17

# Rangeland Management for Wildlife

*Kansas Department of Wildlife and Parks*

**N**ative grass areas are an integral part of the agricultural scene in Kansas. Properly managed rangelands are a necessity for short-term and long-term productivity, including economic return to the operator. Well-managed rangeland also provides vast benefits to wildlife if their needs are considered.

Wildlife use of native grasses is well-documented. Quail, rabbits, prairie chickens, pheasants, pronghorn, and many other wildlife species utilize rangelands. Rangelands are used for nesting, rearing young, feeding, and winter cover. If properly managed, livestock grazing is not harmful to wildlife habitat and in some instances may be used to improve wildlife habitat. Rangelands are also valuable in reducing soil erosion and improving water quality.

### **Burning**

Burning of grasslands is an old practice, one that was used by the American Indian even before the horse era to drive game, to harass his enemies, or to attract game animals to fresh new grass so that hunting would be made easier. Also, a large portion of the prairie burned periodically during dry periods from natural causes. Fire has been one of the most important ecological factors in the evolution of true prairie. The grasses have developed the ability to withstand fires since their perennial parts are all below the soil surface.

Fire is an important ecological tool that is valuable in maintaining native grasses and forbs in a vigorous condition and in controlling the advancement of plant succession.

If fire is eliminated from a range management program, the end result may be an invasion of woody vegetation and cool-season grasses. Control of woody vegetation and undesirable forbs by controlled burning is preferable to repeated herbicide application.

The burning of rangeland should be carefully planned, understood, and carried out with high consideration for safety. The timing of the burn is critical. Properly timed burns can increase desirable warm-season grasses and forbs, which improves food supply and nesting and brood rearing cover for ground-dwelling birds. Removal of the litter improves access to insects while increasing mobility and brood survival of the birds. Late-spring burning generally reduces forbs and certain bunch grasses, such as big bluestem and Indian grass, are increased. Early-spring burning will have the least impact upon plant diversity but

will result in higher soil moisture losses compared to late spring burning. Early-spring burns are preferred over late burns for maximum wildlife benefits. Fall burning has been proven an effective means of controlling annual threawn. Wind velocities of 10-15 mph for burning will generally provide the best results. Do not attempt to burn rangeland without proper training and experience.

### **Haying**

Hay meadows in native rangeland can be detrimental or beneficial to wildlife. When guidelines are not followed, haying can alter composition and reduce vigor of plant communities. Haying, by its very nature, reduces fertility since all plant materials above mower height are removed and not returned to the soil. Haying warm-season grasses should occur around July 1 to 15. Mowing later in the growing season reduces the vigor and composition of the native grass. Plant food reserves are lowered by late-summer mowing since regrowth after mowing draws on storage of carbohydrates (energy reserves used to make new regrowth). Reduced carbohydrate reserves deplete the production potential for next year's growth since time is not adequate for manufacture and storage of additional food reserves before frost kills the food-reproducing green leaves. Thus, weedy species with different growth patterns will invade and degrade the condition of the rangeland.

Mid-summer haying also allows ground-nesting birds, such as pheasant, quail, etc., to complete this nesting season undisturbed by haying activity. The regrowth of grasses after haying is important to many forms of wildlife, which depend upon grasslands for food and shelter through the winter and for nesting and brood cover the following spring.

### **Grazing**

In order to maintain native grassland for livestock production and wildlife management, overstocking must be avoided. An appropriate stocking rate will depend upon the type of livestock, grazing system, current range condition, and other related factors. Light to moderate grazing is less likely to eradicate palatable grasses, legumes, and forbs which are valuable to livestock and also vital to grassland wildlife.

When considering grazing pressure, the concept of "take half and leave half" is a good rule of thumb. Generally, a grass plant produces twice the amount of leaves

which it requires to complete its growth functions. If over half of the leaves are removed during the growing season, root development and other growth is reduced. For example, studies have revealed that when 60 percent of the leaves are removed, approximately 50 percent of the roots cease to grow. How does one determine if only half is being removed? Simply construct a closure of four posts, spaced about 6 feet apart, with an enclosure of woven wire to prevent grazing. Observations during the growing season will provide an estimate of utilization.

A rancher should give consideration to his pasture plants and condition of the plant community in deciding whether or not he is properly using his rangeland. A rangeland plant community provides a perpetual resource for profit and for wildlife. As stocking rates increase from moderate to heavy, the vigor of desirable native plants decreases, undesirable plants increase, grassland quality declines, and profits are reduced. Rangeland must be maintained in good to excellent condition for quality livestock and wildlife production.

### ***Fertilizing***

Fertilizer application on native grass produces mixed results. Nitrogen applications may increase herbage production, but the increase in cool-season grasses and broadleaf weeds may create new problems.

If reestablishment of native grass is the goal, some additional fertilizers (based on a soil test) may be of benefit in establishment of the grass. This may be especially true if seeding occurs on previously cultivated cropland which was drained of soil nutrients. However, nitrogen is not usually needed for the establishment of warm-season grasses.

### ***Livestock Distribution Tools***

Various management factors (fire, haying, etc.) have been discussed in reference to improving and maintaining native grass in the desired stage. Range management specialists recognize several other livestock distribution tools which can aid in improving the quality of native rangeland if overgrazing becomes a problem in certain areas.

### ***Salt Locations***

Proper location of salt or mineral feeders is one of the easiest and cheapest means of regulating distribution. Salting locations are too often near water and loafing areas. Salt and minerals should be placed in suitable containers and not fed on the ground. Carefully select your location in areas that have been underused. Whenever a salt location is moved, drive cattle to that location so that they will know where it is.

### ***Locating Rubbing Posts***

Properly locating oilers can assist in livestock distribution. Oilers should be away from salt and water. If salt or water is needed to get cattle to the oiler, use salt—cattle tend to loaf less at the salt box as compared to water.

### ***Feeding Winter Supplements***

Wintering stock on native grass can produce detrimental effects. If it is necessary that cattle be wintered on native range, the choice of feeding areas can be a factor in managing certain units. Winter feed supplements should be placed in underused areas that occur during the growing season to help distribute some of the pressure.

### ***Water Source***

Location of the water source for a particular pasture is one of the most useful grazing distribution tools; however, new water sources may be expensive to develop. Small ponds can often be dozed in under used areas. Such ponds can hold water for long periods. This type of pond should be placed at the head of small natural drainages and can be especially helpful in distributing grazing on large range units. The best pond design includes a fenced pond with a water line through the dam to a trough below the dam. Fencing to exclude livestock from ponds, wetlands, and creeks, but allowing livestock access to water, will protect sites from trampling and overgrazing. Fencing will improve habitat conditions for wildlife, increase water quality, and lengthen the life of the water source.

### ***Fencing***

Fencing permits breaking ranges into units which are convenient to manage so that growth requirements of the vegetation can be met by proper grazing systems.

An example might be to separate cool-season grasses, such as western wheatgrass, on lowland sites from warm-season species on upland sites. This allows the cool-season species to be grazed early when they should be, keeping livestock off warm-season range until it is ready.

### ***Rotation Grazing***

Rotation grazing can be used to improve distribution by crowding cattle into a range unit and grazing it heavily for a period of time before moving to the next one. Cattle graze less selectively as grazing pressure is increased, resulting in areas being grazed more uniformly. Two range units (paddocks) of about equal size and close together are necessary before rotation grazing can be effective.

A rotational grazing system allows grasses to maintain or increase their growth and vigor during the season and allows enough of the plant to remain at some period during

the season the year to provide good wildlife cover. Under such a system, the period of rest will occur at a different time each year. Movement of livestock from one paddock to another must be based on forage growth rate rather than on a fixed-time schedule. Although each term implies slight differences in management, Savory systems, short-duration grazing, strip grazing, and high intensity-low frequency grazing, all refer to some sort of rotational grazing system.

### ***Range Condition***

Various methods and techniques of improving and maintaining native grass in a vigorous condition to provide quality wildlife habitat and grazing conditions have been discussed. It is evident from general observation if a grassland is being abused or not. The presence of many annual weeds, invasion of nonnative species, or poor cattle gains are indicators of poor range condition. There are grazing systems based on varying responses of certain range plants to grazing pressure. In other words, when rangeland is poorly managed, there are plants which are indicators of poor management.

Range managers appraise the composition of rangeland vegetation to determine range condition. Range condition is based on how much the current vegetation differs from its potential or climax vegetation. Climax refers to a naturally occurring community of living organisms which subsist in a state of balance. The community will have a few species which are dominant, but all species present are able to thrive without undue expense to other members of the community. The introduction of unnatural factors (poor range management) can upset the community balance giving advantage to less desirable species. It is through observing changes in community composition as it relates to its climax state that

condition of the community can be evaluated.

When evaluating rangeland condition, range plant classifications are used. These classifications are based on the individual species' response to heavy grazing pressure and are termed as follows: **Decreasers**—these are the most preferred and most abundant forage species and are dominant in the climax community; **Increasers**—species which increase at first, but later decrease under heavy grazing (except for certain woody plants). These usually are fairly good forage species, but are not able to compete fully with the decreaseers. These plants are species not present in climax, or present in trace amounts (often annual in habit) that invade under heavy-grazing pressure.

Basically, what happens is that decreaseers show a steady decline with increasing degrees of overgrazing, increaseers rise and then decline, while invaders are essentially absent in excellent range condition, and highest in poor condition. Some commonly known decreaseers are big bluestem, little bluestem, and switchgrass. Increaseers are blue grama, buffalo grass, tall-dropseed and ironweed.

### ***Summary***

Well-managed rangeland has several environmental benefits over tilled land: they dramatically decrease soil erosion potential, require minimal pesticides and fertilizers, and act as filter strips to protect or improve water quality. Rangeland managers should consider the needs of both livestock and wildlife before exercising management options.

- Avoid overgrazing.
- Use rotational grazing.
- Fence out ponds, creeks, and wetlands.



## Questions for Chapter 17

1. Why does early burning of rangeland improve wildlife habitat?

2. Explain the concept of “take half and leave half.”

3. Why exclude livestock from farm ponds?

4. How does rotation grazing benefit wildlife?

5. What are “increasers” in a rangeland context?

Name \_\_\_\_\_





## Chapter 18

# Woodland Management for Wildlife

*Kansas Department of Wildlife and Parks*

**W**oodlands are lands naturally covered with trees and shrubs. Woodlands offer wildlife protection from wind and snow, refuge from predators, and a variety of foods not found on other landscapes. Woodlands can reduce air temperature, suppress loud sounds, and produce oxygen into the atmosphere. For the landowner, woodlands offer protection from winter winds, shade in the summer, aesthetic beauty, improve water and air quality, and provide income opportunities.

Wildlife is an integral part of Kansas woodlands. Woodland owners can produce more wildlife in their woodlots with little or no loss of timber production. Forest wildlife, such as squirrels, deer, turkey, and songbirds, will benefit from good woodland management. Other wildlife species, such as rabbits, quail, and raptors, utilize the woodland edge (border where two different cover types come together). Many timber management practices result in good wildlife management practices.

### **Management**

Before a woodland management plan can be designed, landowner objectives must be considered. Many owners will gladly incorporate wildlife management into their plans, if such incorporation does not reduce economic returns. Woodland managers must know the landowner's intended use of the area, what wildlife species the owner intends to manage for, and the potential income the property is supposed to produce.

An inventory of the woodland should be conducted. Inventorying will enable managers to determine which wildlife habitat components are missing. A list of plant species needed can be developed, and information on planting procedures and maintenance of the planting can be provided. A forester and/or a wildlife biologist should be consulted for questions not answered in this manual.

The wooded areas in Kansas have great potential as habitat for a variety of wildlife species. Some woodland habitat management practices that can be utilized to increase wildlife habitat and increase forest product production include: 1) timber harvest; 2) timber stand improvement; 3) planting; 4) woodland border development; and 5) protection.

### **Timber Harvest**

Timber harvest not only allows the owner to receive monetary value from the woodland, but it's also a tool to

improve habitat. By cutting trees for logs, posts, firewood, or other products, we thin the trees and create openings in the canopy. These openings allow sunlight to reach the forest floor stimulating understory growth. Proper harvest keeps a constant supply of timber growing and at the same time regenerates wildlife food and cover.

There are several methods of harvesting trees to aid wildlife. One of the best methods is to remove single trees that are mature. The number of trees removed will regulate the size of the opening created. Wildlife benefit from larger openings.

When harvesting timber, it's important to leave den trees (trees with natural cavities), standing dead trees, food trees, and shrubs and vines. Usually about three or four den trees per acre (preferably with south-facing openings) are sufficient. In any harvesting operation, try to leave a few food producing trees, such as mulberry, oak, hickory, pecan, walnut, or hackberry. These species are utilized by many different kinds of wildlife. After harvest don't burn or destroy the tops and branches. These materials provide excellent ground-level cover for wildlife when constructed as brushpiles near the edge of the woodland or logging road.

### **Timber Stand Improvement (TSI)**

TSI is a forestry practice of removing trees in order to improve the growth rate and/or equality of crop trees. This practice is used to thin out trees whose growth is being restricted by less desirable trees.

By incorporating some of the following suggestions, both wood production and wildlife can benefit using TSI.

- 1) Leave three or four den trees per acre.
  - 2) Don't remove standing dead trees.
  - 3) Kill as many cull trees as possible by girdling them and leaving them stand.
  - 4) Do not chemically treat stumps, as stump sprouts will provide beneficial browse and low level cover.
  - 5) Kill only grapevines that are damaging future high-quality crop trees.
- Other vines, including Virginia creeper and poison ivy, cause little damage and may even be beneficial to crop trees.
- 6) Thin around food trees, such as mulberry, oaks, persimmon, walnut, hickory, dogwood, paw paw, etc.
  - 7) Thinning material can be placed into brushpiles near the woodland edge or just let fall where they will recycle through the soil and provide habitats for invertebrates which may be important food for other woodland species.

8) Clearcutting allows full sunlight to reach to the woodland floor and stimulate new species growth, but it eliminates the value of the woodland for wildlife. Creating openings in large woodland stands will not benefit all wildlife. Some neotropical birds require woodland interiors rather than edges. Also, creating edges has been documented as causing increased nest predation and parasitism by blue jays and cowbirds.

9) Remember to retain buffer strips along creek channels. The Forest Service recommends an undisturbed strip of trees and shrubs at least 15 feet wide to protect the bank from erosion and enhance fisheries. Generally wider buffer strips are necessary to maximize wildlife benefits.

### ***Inter-Plantings***

New plantings of trees and shrubs can replenish timber and improve habitat. Quite often we neglect to replant timber areas that have been harvested and don't contain the proper species of trees for good timber production or wildlife habitat. After a harvest, a decision must be made whether or not to maintain forest openings or allow them to return to forest. This will need to be an "on site" decision based on need for increased timber production or woodland openings for wildlife benefit. In a stand of timber that is in need of mast production, it could be beneficial to replant forest openings with an oak species. If oak mast isn't needed, plant a more valuable tree, such as walnut, or plant to native grass and shrubs for increased "edge."

Quite often odd areas or idle acres (unproductive small acreage of farm land) are unsuited for crop production due to flooding, or they are just too small to farm efficiently. These areas ideal for planting forest crops. If properly planned, these plantings can also benefit wildlife. When planting these areas to forest crops, we can benefit wildlife by planting an occasional food producing tree of the species previously mentioned and also add some wildlife benefitting shrubs. For example, in a walnut plantation, we could benefit wildlife by planting four or five red oak trees per acre and include some autumn olive shrubs between trees in the tree rows.

New plantings can also be utilized to tie small woodlands together and create travel lanes (protective cover for wildlife travel) between woodland or from woodland to water. A good tree and shrub mixture might be best suited for travel lane plantings.

### ***Woodland Borders***

A simple method of creating woodland borders would be to cut the trees within 20 to 30 feet of the woodland edge. If the proper shrubs are present, they will be released from competition and flourish. If not, shrubs, grasses, and legumes can be planted. A good choice might include native grasses and shrubs, such as autumn olive, honeysuckle, choke cherry or fragrant sumac.

By allowing felled trees to remain along the edge of the woodland, the landowner saves time and labor required to remove them and returns nutrients to the soil. These fallen trees provide cover for wildlife and produce insects which wildlife use for food.

An added benefit of woodland borders will be increased crop production near the woodland border. If the owner is willing, it is also beneficial to leave two to five rows of unharvested crops adjacent to woodland borders. Crops that benefit wildlife the most include corn, soybeans, and milo.

### **Protection**

A good forest protection program is essential to good forest and wildlife management. Grazing by domestic livestock can be one of the worst offenders of a good forest-wildlife program. If only one management tool is used in woodland management, it must be fencing to control grazing. Grazing should be eliminated, regardless if it is a new planting or an established woodlot or drainage area. Livestock, especially during winter months, generally compact the soil and knock down, eat, or otherwise destroy tree seedlings and brush. Thus, they eliminate any chance for reproduction or marketable timber and simultaneously destroy essential wildlife habitat.

Although fire is utilized as a forestry management practice in various parts of the country, it is not a practice to be recommended for most woodland areas in Kansas. Most woodlands should be protected from fire. However, fire can provide benefits to wildlife species, such as bluebirds, kingbirds, bobwhite quail, and turkey, in dense woodlands but will definitely decrease the value of the woodland. Fire in woodlands is only recommended as a controlled burn conducted in an area for the purpose of stimulating the development of early successional types of vegetation for wildlife food and cover.

## **Kansas Foresters Serving Your Needs**

*Kansas State and Extension Forestry*

Kansas has over 1.4 million acres of natural woodland. Although less than 3 percent of the total land area, these woodlands are extremely important in providing such benefits as wood products, wildlife habitat, soil erosion control, water quality, recreation, and scenic beauty. Ninety-six percent of the total woodland acreage is owned by private individuals.

Kansas communities support 1.2 million acres of planted forest. While providing a better quality of life for urban residents, this planted forest needs constant care and protection from people pressure.

The following programs, administered by State and Extension Forestry at Kansas State University, are offered at

no cost to landowners or communities in proper management and protection of their tree resources.

## ***Programs***

### **Forest Management**

Private landowners receive technical assistance in managing woodlands for wood products, wildlife habitat, soil erosion control, water quality, and recreation. Assistance includes tree planting, thinning existing woodlands, pruning high-value trees, and timber harvesting.

The Forest Stewardship Program provides technical assistance to landowners to manage their forest for economic, environmental, and social benefits. A stewardship incentive program provides cost-share money to implement a landowner plan developed under the Forest Stewardship Program.

Loggers and mill operators also receive assistance in harvesting techniques, processing logs, and utilization and marketing of wood products.

### **Conservation Tree Planting and Improvement**

The tree planting program sells over one million low-cost tree and shrub seedlings annually for use in conservation plantings. In this cooperative state and federal program, landowners are encouraged to plant trees for windbreaks, woodlots, erosion control, wildlife habitat, and Christmas trees. Order forms including 28 different trees and shrubs are available from State and Extension Forestry, county Extension, and Soil Conservation District offices.

Field studies are under way in our tree improvement program to test, select, and harvest seed from tree orchards used to identify and produce superior varieties of trees and shrubs better suited to Kansas growing conditions.

### **Urban and Community Forestry**

Tree boards, city foresters, and park administrators receive planning and technical assistance in management of the city tree resource. Professional arborists are offered the latest information and training in tree care practices. Individuals and municipalities receive program support in Tree City USA, Global Re-leaf, and other conservation programs designed for populated areas.

The Kansas Urban Forestry Council provides a forum of active volunteer involvement throughout the state. Membership includes tree board members, local government officials, nurserymen, arborists, and citizens interested in improving their community environment with trees.

"Trees for Kansas" is designed to improve the environment by encouraging tree planting in communities and rural areas. The goal of the program is to plant 2.4 million trees annually during the 1990s. Promotional materials are available and certificates are awarded to participants.

### **Conservation Education**

Project Learning Tree (PLT) is a highly successful national environmental education program co-sponsored in Kansas by the American Forest Foundation and State and Extension Forestry. A six-hour workshop provides teachers, 4-H and other youth leaders, and natural resource professionals with training on how to use activity guides containing lessons and activities to supplement existing curricula.

### **Forest Pest Management**

Foresters monitor insect and disease impact in woodlands and conservation tree plantings and recommend control measures for insect and disease problems.

### **Rural Fire Protection**

Our fire program is a cooperative effort to provide assistance to the state's rural fire departments. Services include wildfire training, fire prevention materials, and the acquisition and distribution of excess military vehicles for conversion to fire fighting units. Matching grants to communities under 10,000 population are also provided to help purchase new fire fighting equipment to better protect people and property in rural Kansas.

### **Windbreak Management**

Planning and technical assistance in planting and maintaining farmstead, livestock and field windbreaks are available. Plans include proper design, tree species selection, site preparation, planting instructions, weed control, and long-term care.

### **Forest Stewardship Program (FSP)**

FSP provides technical assistance from a natural resource professional to help landowners manage their forest land and related resources. Development of a FSP plan will address the landowner's goals for managing or protecting timber, soil and water, fish, wildlife, recreation, and aesthetic resources.

### ***Living Snow Fences in Kansas***

Blowing and drifting snow closes many state, county, and private roads during the winter months in Kansas. A great deal of time and money is spent annually on snow removal to provide access. Tree plantings can protect roads from drifting snow and reduce snow removal costs.

The concept of using tree plantings to protect roads from drifting snow is not new. There are many examples of these living snow fences throughout the state.

The use of slatted fences to protect roads from drifting snow has some disadvantages. Slatted fences must be put up and taken down each year, requiring equipment and labor. The fencing material is costly and is relatively short-lived

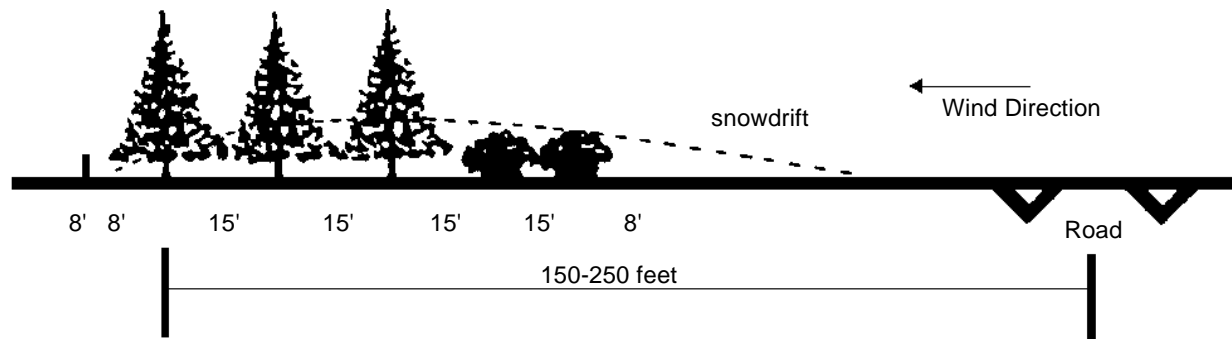

Figure 1. Living snowfence.

compared to the life span of a living snow fence. During severe blizzards, the slatted fence may not trap enough snow to prevent road closures.

Living snow fences of trees and shrubs provide a desirable alternative to slatted fences. Experience shows that properly designed and maintained tree plantings trap more snow than slatted fences while providing several additional benefits. One major benefit of living snow fences is the habitat they provide for a variety of wildlife, including pheasants, quail, rabbits, songbirds, and deer. They can also be designed to provide a suitable calving area and offer protection for livestock during severe winter weather. In addition, living snow fences greatly enhance the appearance of the landscape, and in some instances can improve crop production by providing additional moisture and wind protection.

There are also some disadvantages with living snow fences. They take up more space than slatted fences and they take three to five years after planting before becoming effective.

Compared to traditional slatted fences, living snow fences are cost-effective. An analysis in Nebraska showed they could save \$1,383 per mile per year during a 50-year life span when compared to slatted fences.

Proper design and maintenance are important factors. If living snow fences are not in the proper location, they may actually compound the problem by dumping snow on the road. Living snow fences usually are planted on the north side of east-west roads, or on the west side of north-south roads. The distance from the planting to the road depends on the type of ground cover and terrain on the windward side. In flat prairie land, the windward row should be 150 to 250 feet from the center of the road (Figure 1). Do not create a "blind corner" by planting living snow fences too close to an intersection.

Living snow fences should contain at least two rows of evergreen trees; Eastern red cedar, Rocky Mountain juniper, or oriental arborvitae are especially well suited. An addi-

tional row or two of shrubs will improve the snow-trapping ability while greatly enhancing wildlife habitat. Spacing within the row should be from 6 to 8 feet between trees and 3 to 4 feet between shrub species. Between-row spacing ranges from 10 to 20 feet.

The planting should be long enough to provide adequate protection for the problem area. Both ends of the planting should extend at least 100 feet beyond the area to be protected. This eliminates snow sweeping around the ends of the planting and accumulating in the protected area.

Figure 2 illustrates fence designed to protect both a calving area and a road. Two rows of tall shrubs or evergreen trees on the windward side trap the snow. The snow storage area south of the shrubs may be seeded to native grass. Two rows of coniferous trees on the leeward side provide wind protection for the calving area. The combination of trees, shrubs, and native grass provides excellent wildlife habitat.

Technical assistance in designing living snow fences is available from County Extension Offices, District foresters, or the Soil Conservation Service. Cost-share assistance is available in some counties through the Agricultural Stabilization and Conservation Service office and the Department of Wildlife and Parks.

Related County Extension Publications:

Tree Planting Guide (C-596)

Windbreaks Save Money (C-645)

Windbreak Protection for Beef Cattle (L-708)

Drip Irrigation for Windbreak Plantings (MF-805)

Tree Spacing in Kansas Windbreaks (MF-820)

Windbreaks for Wildlife

Windbreaks as Habitat

Windbreaks have been planted in Kansas for a variety of reasons. Some were planted for landscaping by settlers who missed the forests of their earlier homes. Others were planted as winter protection for homes and livestock.

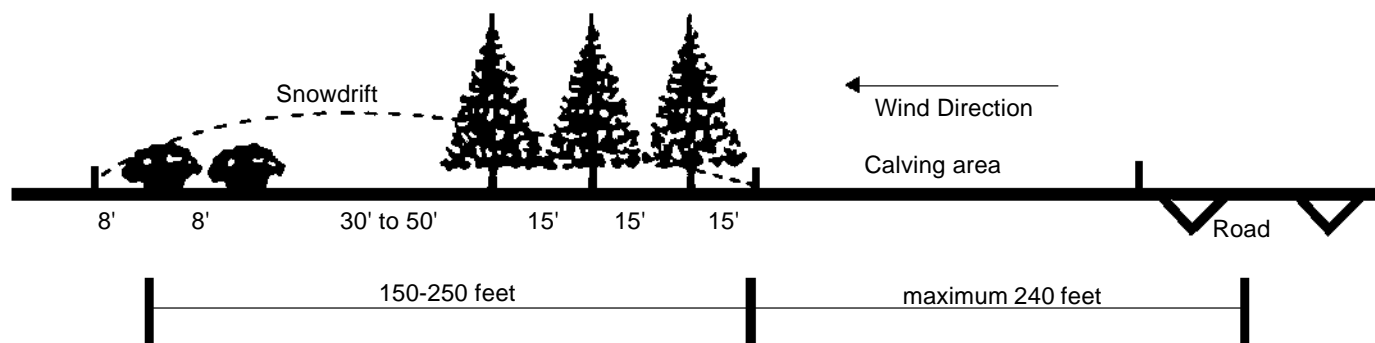

Figure 2. Living snowfence with calving area.

Windbreaks also were established to reduce wind erosion during the Dust Bowl era, when more than 3,500 miles of tree rows were planted.

Another important function, sometimes overlooked, is the wildlife habitat windbreaks provide. Woody cover is essential to many species of wildlife, and windbreaks provide this protection in areas without native timber.

Wildlife has three essential needs for survival: food, water, and cover. Cover is necessary for nesting, loafing, escape, and protection from the elements. Well-designed windbreaks provide all types of cover as well as food. In conjunction with a nearby pond or other water source, they provide permanent homes for a variety of wildlife

### *Design for Wildlife*

Any type of tree planting in a prairie environment will attract wildlife. However, a windbreak designed with wildlife needs in mind will provide better wildlife habitat. The design of the windbreak depends primarily on the species of wildlife to be attracted to the area.

If the purpose of the windbreak is to attract a broad spectrum of wildlife, a larger, more diverse planting is needed. A multi-row planting consisting of conifers, shrubs, and tall deciduous trees will provide permanent homes for many species of wildlife. Figure 1 shows the design of a farmstead windbreak providing good wildlife habitat.

If upland game birds are the desired species, a smaller, less diverse windbreak will suffice. For upland game bird species, a windbreak consisting of two rows of dense conifers and two or three shrub rows will provide adequate habitat.

Snow accumulation in narrower plantings is a major concern. Severe blizzards can completely fill narrow windbreaks with snow and kill upland game birds that have concentrated in the windbreak for protection. A row of shrubs or dense conifers (snow trip row) planted 50 to 100

feet on the windward side of a narrow windbreak will help prevent this. The area between the trip row and the primary windbreak can be planted to native grass or annual food plots.

Best wildlife benefits are realized when windbreaks are planted in an east-west direction. During winter months, direct sunlight is available on southern rows through the day, where wind protection is also greatest. The opportunity to "sun" in a protected site lowers metabolic rates for birds and animals. Food-bearing shrubs along the southern rows create an excellent zone for feeding and protection.

Tree and shrub species used in a windbreak depend primarily on the soils of the planting site. A published soil survey will provide information on tree and shrub species adapted to the planting site. The surveys are available from local conservation districts, Soil Conservation Service field offices, and county Extension offices.

Further habitat enhancement can be achieved by planting a strip of native grass, food plots, or a green strip (clover or alfalfa) adjacent to the windbreak or between the windbreak and the snow trip row. Annual food plots consisting of grain sorghum, sunflowers, or millet can be planted between tree rows during establishment of the windbreak.

### *Establishment*

Successful establishment of any type of tree planting in Kansas involves proper site preparation, good planting procedures, weed control, and supplemental watering when needed.

Site preparation depends on existing vegetation. If the windbreak is to be planted on a sod site, the sod needs to be destroyed and the site summer-fallowed for a year prior to tree planting. If soil erosion will be a problem, the entire site does not have to be broken and summer-fallowed. Killing strips of sod by cultivation or herbicide treatment and planting the tree rows in the killed strips may be adequate.

Cropland sites on heavy soils should be deep chiseled in the fall and disked prior to tree planting. On sandy cropland sites, leave the crop residue; and, if possible, plant directly into the residue in the spring. Proper site preparation will aid in weed control, buildup soil moisture, and allow for proper planting of the trees.

Weed control is essential in newly planted windbreaks. Young trees cannot compete with weeds and grasses. Mechanical cultivation or herbicides can be used for weed control. Weed barrier fabrics can also be used to control weeds and conserve soil moisture.

In the drier areas of the state, supplemental watering may be required for tree and shrub establishment. A drip irrigation system will make watering the planting much easier. However, the use of a drip irrigation system is no substitute for good weed control within the tree rows. If weed barrier fabric is used for weed control and a drip irrigation system is installed, the system should be placed on top of the weed barrier fabric.

## **Management**

Managing established windbreaks primarily consists of protection from livestock and fire. Livestock should never be permitted in a windbreak. Livestock can physically damage trees and shrubs and compact the soil in the windbreak, resulting in poor tree health. Older windbreaks may need to be thinned to reduce competition between trees.

## **Assistance**

Several agencies in Kansas can provide assistance in establishing wildlife habitat. Services provided by the Kansas Department of Wildlife and Parks include technical assistance in planning, design, and management of windbreaks; possible direct assistance in cost sharing on plant materials; and assisting with the actual planting in some areas.

Information and technical assistance on designing windbreaks for wildlife are also available through State and Extension district foresters, county Extension offices, or Soil Conservation Service field offices.

## **Improving Your Woodland for Timber Production**

Kansas has 1.4 million acres of forest land. Ninety-six percent of it is privately owned. As costs of land ownership increase, many landowners are looking for ways to increase their income. Woodland improvement provides one such opportunity.

Timber stand improvement (TSI) can increase growth and quality of a woodland by allowing the growth potential of the site to be concentrated on trees of high quality and value. Timber stand improvement will also enhance wildlife habitat and recreational use. The primary objective, however, is to encourage a stand of high-quality trees to grow more rapidly in volume and value than if left untreated.

There are three specific objectives of timber stand improvement: to increase growth of high value trees, to regulate number and distribution, and to improve trunk quality.

*Increase Growth of High-Value Trees.* Select and mark crop trees so they may be easily identified. Crop trees are trees with no obvious defects, such as lightning scars, or other wounds. They should have large crowns, relatively straight trunks, and high or medium commercial value. Species of high commercial value are ash, black cherry, black walnut, bur oak, white oak, and pecan. Species of medium commercial value are basswood, black oak, chinkapin oak, hackberry, post oak, red oak, silver maple, and sycamore.

Remove trees with low potential for commercial use, undesirable trees, and grapevines which are competing with desirable trees for sunlight, nutrients, and water. In some woodland conditions, it may be desirable to favor a low commercial value species. This would encourage a diversity in species composition to enhance wildlife.

Most woodlands contain many trees that are diseased (cankers, rotten), damaged (fire scar, lightning, etc.), poorly formed (very crooked or forked below 8 feet), or are taking up more than their fair share of the woodland (wolf trees). These trees normally are first to be removed.

Grapevines should only be killed when hindering growth of walnut, bur oak, green ash, and pecan. Other species will tolerate grapevines; and since grapevines are beneficial to wildlife, they should only be killed when necessary.

Do not remove all defective trees and trees of little or no commercial values just because they are in the woodland. Remove them only if they are hindering the growth of more desirable trees or to create openings for underplanting or natural regeneration. Many species require nurse trees to help them grow straight and to enhance self-pruning. Noncrop trees may be left to serve as nurse trees. Many of these noncrop trees make excellent habitat for wildlife. Some of these noncrop trees will develop into den trees. Den trees provide valuable habitat for several kinds of wildlife.

## **Regulate Number and Distribution of Trees**

After removing defective and low commercial value trees, there still may be areas where trees are too close together for optimum growth. In such cases, some desirable trees will need to be removed to allow the remaining trees (crop trees) to develop well-rounded and healthy crowns. Remaining trees should be spaced to allow 3 to 5 feet between their crowns. More space is required as individual trees grow, so several thinnings may be necessary.

Be careful not to thin a stand too early or too late. Thinning too early may result in excess limb development. If an area is thinned too late, the remaining trees will not grow as rapidly.

## ***Improve Trunk Quality***

Trunk quality can be improved by pruning lower branches. The purpose of pruning is to produce defect-free wood for harvest. Species most commonly pruned to produce high-quality products are walnut, bur oak, and pecan. Pruning other species usually does not increase their value sufficiently to pay for the labor. Pruning is not economical on sites with low growth potential.

Trees should be pruned to a minimum of 9 feet with a sharp chain or hand saw. Since the foliage provides energy for future growth, be sure to leave enough to support the tree. Never prune over one-half total height of the tree. Cut live limbs at branch collar. If there is no obvious branch collar, make the cut  $\frac{1}{4}$  inch from the main stem. Do not remove live branches over 2 inches in diameter because larger wounds will close slowly and eventually result in a defect. To prevent tearing of bark down the trunk, make three cuts to remove a live limb. Remove all dead branches and stubs to a height of 9 feet. Do not treat the pruning cut with a wound dressing.

## ***Removing or Killing Unwanted Trees***

Unwanted trees can be cut down or killed standing. When felling unwanted trees, be careful not to injure desirable trees. Stumps of felled trees may be treated with an approved herbicide to prevent sprouting or allowed to sprout for wildlife cover.

Trees can be killed standing by one of three methods: basal treatments, single girdle, or double girdle.

**Basal Treatment.** This method is used for thin barked trees such as osage-orange and honey locust. Saturate the lower 12 to 15 inches of the base of the tree with an approved herbicide.

**Single Girdle.** Make a single cut with a chain saw 1 to 2 inches deep in a continuous ring near the base of the tree then apply herbicide to the cut. If no herbicide is applied to the cut, the tree may bridge over the cut and continue to grow. This is especially true for elms.

**Double Girdle.** Make two cuts with a chainsaw 1 to 2 inches deep and about 3 inches apart in a continuous ring around the base of the tree. With this method a herbicide is not required to kill the above ground portion of the tree. Sprouts may form below the girdle to provide cover and browse for wildlife.

## ***Summary***

Woodland improvement can be beneficial to Kansas' forests in producing high-quality trees. This is done by pruning and removal of undesirable trees and vines. In most cases, trees removed can be utilized as sawlogs, firewood, and posts. Additional benefits include improved wildlife habitat, recreation, and personal gratification.

Technical assistance in improving your woodland can be obtained by contacting your county Extension agent. The county Extension agent will arrange for the district forester to visit your woodland.

## **Related Cooperative Extension Service Publications**

C-640, Wood—An Alternative Source for Home Heating

L-654, Chain Saws: Use and Care

L-655, Felling a Tree

L-718, Improving Black Walnut Stands

C-542, Marketing Kansas Timber

## ***Woodland Management for Farms and Ranches***

A full view of your property and a knowledge of the number of woodland acres are helpful in planning. Your county Agricultural Stabilization and Conservation Service (ASCS) office can provide an aerial photo of your farm, and the staff can help you determine the number of woodland acres.

With the photo in hand, walk through your woodland. Look for and identify on the photo such things as:

- Boundary Lines
- Topography (ridges, slopes, drainage)
- Trees (species, sizes, appearance)
- Soils (rock outcroppings, wet areas, major soil changes)
- Wildlife (observed, trails, signs)
- Ground plants (shrubs, grasses)
- Special features (old homesites, special trees, etc.)
- Openings within woodland (approximate size)
- Adjacent land use (cropland, pasture, etc.)

Take notes on what you observe. Delineate bottomland and upland, noting the types of trees present. Note shrubs and other low-growing plants that provide food and cover for wildlife.

Note openings within the woodland and small bottomland clearings adjoining the woodland. These areas may be excellent planting sites to increase woodland acreage and improve productivity.

Locate streams or major drainage patterns on the photo, along with obvious soil features, such as rock outcroppings, wet areas, and major soil changes. Tree growth depends on soil type and depth. Generally, soils on ridgetops and slopes are shallow, while bottomland soils are deep and fertile. Specific information on soils is available from the Soil Conservation Service (SCS) office.

The type of trees already growing greatly affects present and future benefits. The easiest time to identify trees and other woody plants is during the growing season when leaves are present. A good reference book for tree identification is *Trees, Shrubs and Woody Vines of Kansas*, by H.A. Stephens, published by the Regents Press of Kansas, Lawrence, Kansas.

After gathering this information, you may want to discuss your findings with an Extension forester before taking the next step. Since you will be familiar with the woodland, you will be in a better position to understand and discuss the forester's recommendations.

### ***What Now?***

After becoming acquainted with your woodland, you have three alternatives:

1. Do nothing—leave the woodland as it is.
2. Convert a portion of the woodland to another use.
3. Improve the woodland for greater benefits.

### ***Leave it as is***

Many people have the misconception that woodlands remain the same if left alone. Woodlands, however, are dynamic communities. Trees begin life, grow, and die, constantly changing the appearance of the woodland. Tree species also compete with one another. For example, oak and hickory eventually dominate unmanaged upland areas while hackberry and ash may dominate bottomlands. Many

popular commercial species, such as black walnut and pecan, will gradually disappear from the woodland.

Doing nothing is seldom a good choice. It usually is more costly in the long run when lost benefits are considered. For example, you pay taxes each year whether the woodland is working for you or not. Can you afford not to use your woodland?

### ***Other Uses***

Converting part of the woodland to other short-term agricultural uses may seem to be a good alternative. However, before clearing, it is wise to compare the costs of clearing with the benefits from a productive woodland. Consider also the impact on the land from a rapid shift in use. Clearing a woodland may cause excessive soil erosion and stream pollution.

There may be certain wooded areas on your farm composed entirely of undesirable trees that you want to clear. For example, an old field may have reverted back to honey locust, elm and osage orange. If the soil is conducive to good tree growth, consider planting desirable timber species in the area.



## Questions for Chapter 18

1. What is timber stand improvement?
2. The Forest Service recommends a buffer strip at least \_\_\_\_\_ feet wide to protect the bank from erosion.
3. How do woodland borders benefit wildlife?
4. List two reptiles and two amphibians that use snags.
5. Living snow fences show cost savings when compared to traditional slotted fences. What was that savings in a recent Nebraska study?
6. What are the key things to consider for a successful establishment in a tree planting?

Name \_\_\_\_\_



## Chapter 19

# Wildlife Management on Croplands

*Kansas Department of Wildlife and Parks*

**M**any sportsmen and farmers alike feel that cropland and associated waste grains are all wildlife need to survive. They are somewhat startled when the Kansas Department of Wildlife and Parks recommends less cropland and more emphasis on native grass and other habitat types. Waste grains are important to most wildlife as supplemental winter foods. But croplands in general provide substandard nesting or brood rearing areas.

Wildlife can be important to the grain producer, not only from the standpoint of providing a few days of fall hunting but also simply for the pleasure derived from seeing them. Many of our wildlife species are important in controlling insects, rodents, and other farm pests. Seed eating wildlife can also reduce weed and volunteer problems.

### *Crop Selection for Wildlife*

Almost every crop grown in Kansas has value to one form of wildlife or another. Which crop is most beneficial depends on what type of wildlife you are concerned with, what time of year it is, and what other habitat types are found in the area. During the fall, a green wheat field provides little to a quail or pheasant, but it may be used by deer or geese for a food source. However, in an area lacking in good, grassy nesting cover, pheasants may utilize wheat as a nesting site in the spring.

Since interest is usually in many wildlife species, planting a variety of crops will allow wildlife to seek out their preference. In a large field, strip-cropping, or dividing it into smaller units, will provide much greater benefits.

The utilization of several crops in one area also protects the producer by giving him an insurance policy against a failure of any one crop.

Grains, especially sorghum, corn, and wheat, are the most important crops to wildlife as supplemental food sources during periods of heavy snow cover. For certain species, such as the ring-necked pheasant, they are important each winter; however, heavy snow can render stubble fields useless for many wildlife, such as quail, that are unable to scratch through the deep snow to find waste grain. A few rows of standing grain, especially if these uncut rows are adjacent to areas of good cover, can be very valuable to vulnerable wildlife in severe winter conditions. Leaving four to six rows in several short strips rather than one or two over an entire border is preferable. Soybeans are utilized by many Kansas wildlife species but often are buried and are unavailable after heavy snow.

Studies evaluating the use of legume crops (such as alfalfa, clovers, or soybeans) in rotation with corn or grain sorghum in Kansas have been continuing for more than 50 years. Results from this work show important benefits from the legume rotation and the value of the nitrogen fixed by the legumes. Legumes add significant nitrogen to the soil thus reducing the fertilizer needs. Other benefits from legumes in rotation are breaking of insect and disease cycles that are problems in monocultures. For example, the control of rootworms (a saving of \$8 per acre) is possible with the implementation of a good rotation system with legumes.

Wheat and other small grains provide green browse for geese, deer, and other wildlife. In areas where suitable nesting cover is unavailable, wheat may be utilized for this purpose; however, except for pheasants, wildlife production in such areas is limited. This is due to lack of nesting material, vulnerability of cropland nests to rainfall, and early harvest. In order to avoid destruction from the harvest operation, the clutch must be hatched and the brood gone from the field prior to harvest, which is normally late June to mid-July, depending on the portion of the state involved.

Wheat stubble in fallow fields can be very important to upland game, especially those fields in which sunflower, kochia, or other weeds are allowed to grow. Although not preferred as much as milo, corn, or soybeans, wheat stubble fields provide cover and food in the same field. Wildlife utilizing these fields will not only eat waste grain but various weeds seeds.

Alfalfa, red clover, lespedezas, and similar hay crops can be excellent nesting and brood rearing areas. But danger associated with haying can turn hayfields into death traps. The peak quail and pheasant hatches occur in June. In most instances, the hen is still on the nest at the time of the first cutting of alfalfa. The nest and often the hen are generally destroyed. Young broods are not adept at avoiding machinery and also are often destroyed during mowing.

To lessen the effects mowing of legumes has on wildlife, some precautions can be taken. By mowing a swath through the center of the field, then working toward the outward, broods would have a better chance to escape unharmed. Usually, the majority of nests are found within 50 feet of the field's perimeter. If economics allow it, a 20- to 30-foot border strip can be left unmowed. Chances are some nests will still be destroyed, but nesting hens displaced by the mowing will likely re-nest in the unmowed strips.

## ***Tillage***

Perhaps more important to wildlife than the diversity in crops already suggested is the tillage practices employed by the operator. Large, clean-tilled, fall-plowed fields will not be attractive to wildlife.

### **Spring Tillage Versus Fall Plow**

Fall tillage may sometimes be convenient, but this practice encourages soil erosion and reduces soil moisture. By leaving the stubble until spring, fields are protected from erosion. The stubble will also reduce evaporation and catch snow, both of which will improve soil moisture carry-over.

Fall tillage destroys almost all wildlife benefits available from cropland during the winter. Leaving the ground unworked is preferable until most long-term adverse weather is over and until other food sources begin to develop.

### ***Weed Control Practices***

Clean, weed-free croplands are of much less value to wildlife. While weed control is critical in farming, modest levels of weeds may not affect yields sufficiently to justify the expense necessary to control them. The operator must determine the point of weed infestation at which it is most effective to initiate controls. The reduction in wildlife utilization from this operation should also be considered.

### ***Border Areas***

Highly beneficial areas to wildlife on farms are field borders. Wildlife activity on cropland is often in or near a field border. Wildlife use these borders as travel lanes for nesting and brood rearing areas (when grasses or similar cover are present) and for protection from predators and the elements.

Although all borders are important, there are ways in which one can improve the wildlife utilization of these areas. Borders are weedy fencerows, hedgerows, shrubs or grass strips. The most important factors in determining a border's benefit to wildlife are its width and the variety of plant life within a border.

### **Width of Border**

A border made up of only a barbed-wire fence will attract very few wild animals. A few weeds along the fence, making a border only 1 or 2 feet in width, will markedly increase wildlife utilization. As the width of the border increases, so do the wildlife benefits. The best field borders are 15 to 20 feet wide.

The wider border of 20 to 100 feet can become more than simple travel lanes. Nesting, brood rearing, roosting, and other activities will also occur there.

### **Diversity of Plants in a Border**

Plant diversity is the number of different plant types and species occurring in a relatively small area. As plant diversity increases, so do wildlife benefits. A border with only osage-orange trees (hedge) is not as valuable to wildlife as a hedgerow with various grasses and weeds under the osage-orange trees. The most beneficial field borders will contain mixtures of native grasses, annual and perennial weeds, shrubs, and various trees.

Fruit or nut bearing shrubs and trees further enhance the value of the border. Native species adapted to your area will work best. Similarly, native grasses like switchgrass, Indiangrass, or little bluestem are superior to tame grasses like brome or fescue.

### ***Edge***

Edge is the narrow transition zone between any two types of vegetation. This may be a border, but not necessarily. Edge allows wildlife from different habitats to share the same area. Planting crops in linear strips rather than short, wide fields will dramatically increase quantity of edge. Numbers of many wildlife species are directly related to the amount of edge present.

### **Large Fields Versus Small Fields**

Large fields have a very small percentage of borders and edge when compared to several smaller fields. For example, four 40-acre fields could have 3 miles of borders, whereas, a single quarter-section field will have only 2 miles. Four 40-acre strips will yield 3.5 miles of edge. Since most wildlife are dependent upon edge, strips will produce the most wildlife benefits. It is also easier to work the long, narrow strip with modern machinery than it is the shorter width field of equal acreage.

### **Conservation Tillage and Agricultural Chemicals**

Conservation tillage can also be of tremendous benefit to many wildlife species. Essentially, it is reducing the number of tillage operations used so that protective amounts of crop residue are left on the soil surface. No-till, mulch till, and ridge-till systems are being implemented throughout Kansas. Conservation tillage provides year-round crop residue for erosion control, leaves some crop seeds on top of the ground for food, and provides cover in areas left bare under conventional tillage systems. Conservation tillage can significantly reduce disturbance of ground-nesting birds. Studies indicate that there may be as many as seven times the number of nests in no-tilled fields as in conventionally tilled fields.

Usually, a conservation tillage system relies upon increased amounts of agricultural chemical. Herbicides rather than tillage may permit nesting cover maintenance

throughout the nesting season. Some weeds in a field are important in providing diversity and additional food supply. Many weed seeds are higher in metabolizable protein than conventional cereal grains. However, weed control should be based on economics rather than a cosmetic decision.

Pesticides can affect wildlife in many ways. Some chemicals are toxic enough to directly kill wildlife. Others weaken animals so that they are more likely to die of disease, exposure to harsh weather, or predation. Producers should avoid any application method that allows considerable drift or runoff. The use of ultralow volume applications by ground or air equipment and the use of some granular pesticides should be avoided.

The key to reducing pesticide use is frequent inspection of fields, correct identification of pests, evaluation of potential damage, and integration of nonchemical and control methods. This is commonly called integrated pest management.

### ***Summary***

With over 25 million acres in cropland in Kansas, croplands cannot be overlooked as wildlife habitat. Cropland management decisions must be modified to improve wildlife populations statewide. Crops by themselves do little to support year-round populations of desirable wild animals; however, the techniques discussed above will benefit wildlife and can often be incorporated into current farm operations without significant economic impact.

### **Some important things to remember:**

1. Utilize no fall tillage.
2. Use a greater variety of crops in farm rotations.
3. Maintain grassy field borders as turn rows and filter strips for row crop situations.
4. A few scattered weeds provide benefits to wildlife without reducing crop yields.









## Chapter 20

# Habitat Improvement Practices and Guidelines

*Thomas G. Barnes, Jeffery D. Sole, and John Phillips*

In this chapter, various habitat improvement practices are listed in Table 1 according to the species of wildlife the practice benefits. Most practices are then briefly described. You should learn as much as possible about any practice before implementing it. Additional reading and guidance from wildlife management professionals are recommended. The chapter is divided into two major sections: habitat management for forested areas and habitat management for agricultural areas. Some seed sources for native grasses and wildflowers are listed in Appendix A.

### *Habitat Management Practices for Forested Areas*

**Clearcutting.** Clearcuts should be kept fairly small (not exceeding 20 acres). Clearcuts ranging in size from 5 to 10 acres are preferred (Figure 1). The smaller the cuts, down to a patchwork of 1-acre clearcuts, the better. Clearcuts should be long, narrow, and irregular in shape to take advantage of natural contours, thus creating more habitat diversity (Figure 2).

**Selection Cutting.** Selection cuts should also be kept fairly small (Figure 3). Like clearcuts, they should not exceed 20 acres. The trees selected should be overmature and poor mast-producing trees. Select only trees that are more than 16 inches **dbh** (diameter breast high). This allows more vigorous trees to reach maturity. It also allows more sunlight to reach the forest floor to promote the growth of understory plants. Selection cuts should also be long, narrow, and irregular.

**Thinning.** In extensively forested areas, mast is important in helping numerous wildlife species survive the winter. Careful attention to thinning around mast-producing trees can boost mast production. Thinning operations should be less than 35 acres and scattered evenly throughout the forest (Figure 4). During the fall when mast is present, mark the best mast-producing trees over a two to three year period. The non-producing trees can be removed or girdled. Do not remove oak species that are not bearing during the current year but that might bear in succeeding years.

Thinning operations should be directed toward maintaining a balance of red and white oak species in the stand. This ensures that a failure of one species to produce acorns will not mean a complete failure of mast production during a particular year.

**Edge Feathering.** This practice involves removing portions of the forest canopy in areas where a timber harvest is not planned (Figure 5). Approximately 75 percent of the overstory or canopy is removed from the first 50 feet of the forest edge. Fifty percent of the forest canopy is removed from the next 50 feet, and 25 percent of the canopy is removed from the next 50 feet of forest. The end result will be a 150-foot-wide band of “feathered edge” around the forest. Sunlight reaching the forest floor will stimulate new plant growth, and thick, shrubby vegetation will develop.

**Leave Areas of Old Growth Forest.** When harvesting timber from any appreciable acreage, leave a few areas of 20 to 100 acres with good mast-producing trees (Figure 6). This will ensure a dependable food source for many wildlife species while forest regeneration is occurring. Often, these leave areas can be 300-foot buffer strips along stream or drainage corridors where harvesting should be limited anyway.

**Maintenance of Cavity Trees.** Snags and/or “wolf trees” with cavities should be left standing during and after any timber harvest (thinning, salvage cut, clearcut, or shelterwood cut) (Figure 7). These trees provide needed nesting, foraging, and winter cover for a variety of wildlife species. Standing snags do not hurt forest regeneration, and they provide an important habitat component of the future young timber stand. Some species found in Kansas that use snags or logs are listed in Table 2. If you must remove some snags or wolf trees, leave the largest relatively sound trees with cavities already present. When possible, six to eight cavity trees per acre should be left standing in any timber harvest. As a general rule of thumb, leave a minimum of four snags at least 6 inches dbh. Whenever possible, leave five snags with a dbh of greater than 18 inches, 15 snags with a dbh of greater than 14 inches, and 25 trees with a dbh greater than 6 inches per 10 acres of timber harvested.

**Table 2. Kansas wildlife that use snags or logs.**

<b>Amphibians</b>	<b>Mammals</b>
American toad	Cottontail rabbit
Spadefoot toad	Chipmunk
Leopard frog	Gray squirrel
Tree frog	Fox squirrel
Salamander	Flying squirrel
Newt	Field mouse
	Shrew
<b>Birds</b>	Bat
Primary cavity nesters:	Opossum
Pileated woodpecker	Skunk
Northern flicker	Weasel
Red-bellied woodpecker	Mink
Red-headed woodpecker	Raccoon
Hairy woodpecker	Red fox
Downy woodpecker	Gray fox
Secondary cavity nesters:	<b>Reptiles</b>
Wood duck	Mud turtle
American kestrel	Painted turtle
Barred owl	Box turtle
Screech owl	Wood turtle
Chimney swift	Lizard
Tree swallow	Skink
Purple martin	Garter snake
Black-capped chickadee	Earth snake
Tufted titmouse	Bull snake
White-breasted nuthatch	Fox snake
House wren	Black rat snake
Eastern bluebird	King snake
Starling	
House sparrow	

**Woody Debris Management.** During a timber harvest, there is always a considerable amount of hollow logs, tree tops, and slash left after the removal of the merchantable timber. A patchy distribution of slash and tree tops in piles or short rows provides habitat for a variety of wildlife species. The slash can be windrowed into rows and left along the outer edges of the cut. This provides an abundance of well-distributed cover. Do not leave the slash or debris in or near any stream or drainage area. On slopes, orient the logs along the contours and place them near stumps if possible. This reduces runoff and siltation problems.

**Log Landings/Skid Trails.** Log landings and skid trails should be seeded to a legume or grass-legume mixture (Tables 3 and 4) to provide brood habitat and feeding areas for a variety of wildlife species. Depending on the surrounding land-use patterns, these areas should be maintained as woodland openings in permanent grass-legume mixtures. To maintain these areas, the use of controlled burns, selective herbicide application, bush-hogging, or manual removal of woody material once every five years should be adequate.

**Maintaining Soft Mast.** Soft mast-producing trees, shrubs, and vines are very important food sources for many forest wildlife species. Species like dogwoods, wild grape vines, black cherry, greenbriers, and sassafras should not be removed during a timber harvest or during site preparation. Many forest managers destroy soft mast producers during site preparation for forest regeneration. Maintaining plenty of good soft mast producers within any timber stand is essential for a variety of wildlife species.

**Stream, Creek, and Drainage Management. Riparian zones** are lands adjacent to streams, rivers, lakes, and wetlands. They are highly productive ecosystems because they receive nutrients, water, and energy from the adjacent uplands. These areas are an important feature of the forest because they:

- *reduce runoff, erosion, and sedimentation,*
- *filter water and replenish groundwater reserves, and*
- *help to moderate flooding.*

They are also important habitats for wildlife because the vegetation is often unique and very diverse. Riparian zones tend to be linear and create travel corridors to other habitat types. They are vitally important for fish because the overhanging vegetation provides cover, and the shade prevents extreme temperature fluctuations harmful to aquatic organisms. Special riparian areas that contain old growth forest, wetlands, threatened or endangered species, or unique scenic values should be considered for management on a case-by-case basis. The following general recommendations are based on stream size (Figure 1).

Buffer zones should be created within 300 feet of a stream or river that drains more than 50 square miles. No timber should be harvested within 100 feet of the stream or river. Light selection cutting of stems less than 6 inches dbh may be permitted in the zone from 100 to 300 feet. No more than 40 percent of the timber volume should be removed per 10-year period. Buffer zones along streams draining less than 50 square miles should be a minimum of 100 feet on each side of the stream. Trees along streams draining less than 300 acres and seasonal or intermittent drainages should be maintained. The number of stream crossings for roads should be minimized and be kept as narrow as possible. Places where stumps are dumped and steep banks that would inhibit wildlife travel along and across streams should be avoided. Seeding roadsides and ditches within the buffer zone is recommended.

**Woodland Openings.** In areas of extensive forest, openings in the forest are beneficial to many wildlife species. Forest openings should be no smaller than one-quarter acre nor larger than 10 acres. These openings are best designed in irregular shapes to create maximum edge. Long, linear openings should be 50 to 200 feet wide by as long as possible. These woodland openings can be planted

**Table 1. Habitat management practices for selected species.**

	American kestrel	Beaver	Bullfrog	Brown thrasher	Canada goose	Eastern cottontail	Grasshopper sparrow	Greater prairie chicken	Hummingbird	Mallard	Mourning dove	Mule deer	Northern bobwhite	Pronghorn	Raccoon	Ring-necked pheasant	Tree squirrel	Wild turkey	White-tailed deer	Wood duck	Largemouth bass/bluegill
Artificial feeder					×			×	×	×	×	×	×		×	×	×	×	×		×
Brush pile			×			×							×								×
Bush hog	×												×								
Conservation tillage	×			×		×							×		×	×	×	×			
Construct nesting islands			×		×					×											
Controlled (prescribed) burning	×			×	×	×	×	×		×	×	×	×	×		×		×	×		
Delay haying					×		×	×		×		×	×			×		×			
Disking strips in grassland	×							×			×		×			×		×			
Do not disturb nesting place	×			×	×	×	×	×	×	×	×	×	×		×	×		×		×	
Grain, leave unharvested					×	×		×		×	×	×	×		×	×	×	×	×		
Guzzlers						×		×			×	×	×	×	×	×		×	×		
Livestock grazing management	×	×	×	×	×	×	×	×	×	×	×	×	×	×	×	×	×	×	×	×	×
Nesting boxes, structures, platforms	×				×				×		×						×			×	
Plant flowers	×			×		×	×	×					×			×		×			
Plant food plots					×	×		×		×	×	×	×	×	×	×	×	×	×	×	
Plant grass and legumes							×	×		×	×	×	×	×		×		×	×		
Plant mast trees										×			×				×	×	×		
Plant trees or shrubs	×			×		×					×	×	×		×	×	×	×	×	×	
Pond construction		×	×		×					×	×				×	×			×	×	×
Ponds, renovate		×			×					×	×				×					×	×
Ponds, determine balance																					×
Ponds, reseed watershed/filterstrip			×			×	×	×		×	×		×			×		×	×		×
Ponds, restock			×																		×
Ponds/lakes, artificial reefs																					×
Ponds/wetlands, shallow water		×	×		×					×	×				×	×			×		
Predator-proof fencing			×		×					×											
Preserve den trees	×														×		×			×	

to a grass-legume mixture (Tables 3 and 4) and maintained as permanent openings or simply allowed to revert to forest. If you wish to maintain them in permanent openings, you may have to bush-hog, hand cut, or use herbicides every few years to prevent woody encroachment.

**Woodland Ponds.** Small woodland ponds, approximately 30 to 40 feet across, with varying depths can be created in log landing areas or small clearcut areas on the ridge tops. These small ponds in forest clearings will provide habitat for numerous frogs, toads, and salamanders. They will also be used by deer, turkey, and other species of wildlife. See Chapter 11 for the requirements for building a pond in these areas. Ponds should vary in depth from several inches to 4 or 5 feet deep. Brush can be placed in the shallow end to create habitat for amphibians and invertebrates. The perimeter around these ponds, with no embankments, should be seeded to a grass-legume mixture (Tables 3 and 4). Contact the SCS for ideas and technical guidance on building a pond.

**Creation of Artificial Nesting Sites.** Many species of wildlife depend on hollow trees, or trees with cavities, for their nesting and wintering habitat. All too often these are the first trees to be cut for firewood by the unknowing landowner or as part of timber stand improvement practices. On many farms the forests and woodlots have been cut several times, leaving young woods with few den trees. In these areas the use of nest boxes can increase the carrying capacity for cavity-nesting wildlife. There is evidence that bird, squirrel, raccoon, and wood duck populations can be increased locally by the erection of artificial nest boxes in woodlots where natural cavities are scarce. Cavity trees suitable for wildlife should exist at a rate of no less than three per acre. If you survey your woodlot and get less than this number, you can supplement natural cavities with artificial nest boxes. A squirrel box may have screech owls, kestrels, deer mice, flying squirrels, gray squirrels, or fox squirrels using the box within a few years time. Many species of farmland wildlife can also benefit from a properly built and erected nesting box. Because many predatory animals are attracted to these sites, it is wise to place a predator guard under the nest box.

**Creation of Salt Licks for Deer.** Select a location that provides deer some protection (edge of the woodland). Remove any debris and leaf litter in a 3-foot circle. Loosen the soil with a hoe. Combine 5 pounds livestock mineral (dicalcium phosphate) and 20 pounds of trace mineral (red) salt. Spread this mixture evenly over the prepared site. Using a shovel or hoe, combine the salt into the soil so it is well mixed. Resupply the lick as needed.

### ***Habitat Management Practices for Agricultural Areas***

By far the major problem facing small game in Kansas today is the lack of suitable reproductive and winter cover.

The use of heavy sod-producing grasses, such as fescue and brome, has almost eliminated this type of cover. Good management for small game makes use of techniques that disturb the soil on a frequent basis (every three to five years). Several methods can be used to create soil disturbances beneficial to small game. The most common of these techniques are described below.

**Fallow Fielding and Crop Rotation.** One way to create small game cover is to incorporate a crop-rotation practice which will let recently cropped lands lie idle for a period of time. A crop-rotation pattern, such as corn, winter wheat, soybeans, hairy vetch (two years), and back to corn, will produce good results. Another crop-rotation pattern might be corn, winter wheat, and a legume (two years). Also, consider a rotation of corn or milo followed by three years of fallow field back to the row crop. Whatever crops planted, including a year or two of fallow fielding or legume cover in the rotation will benefit many wildlife species.

**Strip Disking or Plowing.** In less intensive agricultural situations like an old field pasture or abandoned area, soil disturbance must be created specifically for small game. Strip disking or plowing is often done for this purpose. Strip disking/plowing should be done in long linear strips 30 to 50 feet wide by as long as possible next to or paralleling brushy or woody escape cover. The ground is simply plowed or disked and left alone. The disturbed area should be left fallow for three years following the disking. Usually after three years the vegetation will become too thick for small game to use. Weedy species, such as foxtail, ragweed, partridge pea, Korean lespedeza, and others, will volunteer in these fields. These are heavy seed-producing plants which provide a high-energy food source for wildlife.

**Small Game Food Plots.** Food is generally not limiting in Kansas for small game. However, a food plot can provide a source of late winter food and serve as an insurance policy against severe winter weather. Food plots should be long and linear (30 to 50 feet wide by as long as possible) placed near good cover (brushy, woody, or odd areas). Many small game food plots are no larger than one-quarter acre. You should consider planting one food plot per 40 acres. Food plots should be set up on a rotational basis leaving a plot idle for three years following planting. This allows the habitat to develop and provide the same benefits as the strip disking or plowing techniques. Corn, grain sorghum (milo), and pearl millet are excellent crops to plant in small game food plots (Table 5).

Any of the above soil-disturbance or fallow-fielding techniques can be enhanced further by overseeding a legume, such as Korean lespedeza or ladino clover. This should be done the winter following the creation of the food plot or field. Legumes attract large numbers of insects which are essential to young birds during their first 2 or 3 weeks of life.

**Dove Food Plots.** A number of grain crops can be grown and manipulated specifically for attracting and feeding doves. The key points to remember are:

- 1) *keep some open bare soil areas for the doves to feed from,*
- 2) *keep the field close to a water source, perching sites (large trees or snags, power lines, fencerows), and roosting areas, and*
- 3) *have a variety of crop fields that provide food from mid-summer through the fall (this sequence might be wheat, millets, sunflowers, milo, or corn).*

Some farmers plant mixtures of these crops in the same fields letting the different crop maturation dates work for them.

Regardless of the crops chosen, dove field managers should plant the crops in 10- to 15-foot-wide strips with a 10- to 15-foot-wide strip of unplanted ground in between each planted strip. The unplanted areas are kept clean by periodic disking throughout the summer. This practice will attract doves throughout the summer and may establish feeding patterns that will be maintained throughout the fall.

What to plant? Probably the number one crop that can be planted in a dove food plot is the small, black oil type sunflower (Perodovick). These sunflowers should be planted in early to mid-April. The seed can be broadcast at 10 pounds per acre or drilled in rows at 6 pounds per acre. During the late summer or early fall when the heads have matured, bush-hog 15- to 30-foot-wide strips through the field to knock some of the seed to the ground. You should leave a 20- to 30-foot-wide strip of sunflowers standing around the edge of the field. This area should be followed the following year to provide habitat for quail and songbirds.

There are three ways to use wheat fields for attracting doves. Wheat fields can be planted during the fall as a winter cover crop. The wheat is planted in mid-September through October at 60 to 90 pounds per acre. It is either cultipacked or lightly disked into the seedbed. Doves will be attracted to the sowed seed. It is important to use only the normal seeding rates because using a heavier rate would be considered baiting, which is illegal.

Wheat fields can also be harvested to benefit doves. Harvest half the crop in late July when it matures and the remaining portion in late August. This will attract doves to the site. The early harvested section must be kept bare or nearly so. Weedy growth may need to be mowed as close to the ground as possible several times to keep the field attractive to doves. If the mowed vegetation becomes matted, you should rake it into windrows to keep the ground open.

Wheat can also be planted and managed as a food plot in the same way you would treat sunflowers. To keep doves feeding in an area, strips should be bush-hogged beginning in late July as the crop ripens. A portion of the crop can be bush-hogged every two weeks to keep the birds feeding.

Various millets, including German foxtail, pearl, proso,

and browntop, are commonly used to attract and feed doves. Millets should be planted in late May and early June. You may wish to use later plantings until early July to attract doves throughout the fall. The seed should be broadcast at 15 to 20 pounds per acre and lightly disked or dragged into the ground.

Wheat and milo fields probably provide the majority of dove feeding fields in Kansas. The crop should be harvested in a two-stage process if possible. One-half of the field should be harvested in early to mid-August and the other half in early to mid-September. This can be followed with a winter cover crop of wheat or oats.

Hayfields planted to millet or a millet-soybean mixture are highly attractive to doves. This crop also provides a good winter livestock forage. To use this hay crop for doves, plant in early June so the seed heads will be mature when the crop is harvested. If possible, cut and bale half the field in mid-August. Cut and bale the remaining half in late August. Run the hay through a conditioner if you have one. Conditioning increases the quality of the hay and shatters many of the seed heads, thereby scattering the seed on the ground for doves. Turning the hay with a rake several times before baling will also release the seed.

If you are going to hunt over the dove fields, keep several important things in mind. **Federal law prohibits baiting of doves and other migratory birds.** Be certain to check with a local conservation officer before the season to determine what practices are acceptable. Hunter management is also a necessity to provide a safe, quality hunting experience. A well-designed 5- to 10-acre field should support 10 to 20 hunters in most cases. Hunting should be terminated early enough to allow the birds time to feed unharassed before roosting (two hours before sunset). The fields should not be hunted daily. A good practice is to allow hunting on alternate days or even better, every third day.

**Deer and Turkey Food Plots.** Big game food plots range in size from 1 to 5 acres. Improved pastures planted to a mixture of legumes (clovers and lespedezas) and orchard grass with winter wheat as a nurse crop will also be used by turkeys and deer during the spring and summer. Before planting, be sure to lime and fertilize the soil in accordance with soil test recommendations. Contact your local Cooperative Extension agent for information on soil testing and requirements for fertilizing and liming. A good mixture to plant on a per-acre basis would be 90 pounds winter wheat and 25 pounds orchard grass planted between August 15 and September 15, followed with a planting of 15 pounds of ladino clover between February 15 and March 15. This crop could be cut for hay. See the section on mowing for guidelines.

Winter wheat, canola, corn, and soybeans are also used for winter food plots. Winter wheat should be planted in September in a quarter-acre long linear strip next to the woods or brushland. Seed at a rate of two bushels per acre. Canola can be planted in September in quarter-acre long

linear strips seeded at a rate of 18 pounds per acre. Corn and soybeans should be planted in May and early June within 100 yards of forest or brushland in quarter-acre linear plots.

Any food plots should be placed in a rotation schedule. The recommended rotation is soybeans, wheat, corn (which is left standing for small game), canola, soybeans, and a grass-clover field for two to four years. During years of poor acorn production and severe winters, food plots will be heavily used by deer and turkeys. During good mast years and mild winters, you may notice little use because turkeys and deer prefer acorns and other native foods when available.

Food plot recommendations for deer are designed to raise the carrying capacity of the area. It does not make sense to use food plots if your deer have enough to eat without them. If you are attempting to increase your herd, food plots should be added gradually. The acreage should be increased to help feed the increasing deer herd. You will eventually reach a point at which the habitat will start to suffer damage as the herd increases. Even though the deer are not suffering nutritionally, they have damaged their natural food supply. In past years, deer herds have been increased on artificial feeding or food plots only to have the owners abandon the project because it was too expensive. The outcome was starving deer and over-browsed woodland.

**Mowing Hayland.** Many game bird nests or young birds and deer fawns are lost each spring because of farmers mowing hay or bush-hogging fields. If possible, avoid mowing or clearing thick, brushy areas from April through early August. Late March and early April or mid-August and September are the best times to mow. Mowing at these times allows for sufficient plant growth to provide nesting or winter cover. If work is planned for a hayland or weedy area, it would be best to clear it before nesting season (keeping hens from nesting there). If hay must be cut during the nesting season, drive a tractor around the field 40 to 50 yards from the edge to see if any hens flush. If nests or young deer are suspected, leave as much tall vegetation around the area as possible. Turkey hens may abandon a nest if it is disturbed one time. Subsequent disturbances almost guarantee an abandoned nest.

In areas where fields are to be maintained as open areas without grazing or haying, strip mowing or mowing in a mosaic pattern can increase habitat diversity for small game. Strip mowing should be done in long linear strips 30 to 50 feet wide by as long as possible. Using a mosaic technique involves mowing small patches in an irregular pattern. These mowing methods will maintain portions of fields in herbaceous vegetation while allowing clumps of blackberry, buckbrush, and tree seedlings to develop. These clumps will need to be mowed to regenerate themselves when it looks as if the saplings and shrubs will soon get too big for your tractor and mower. Hayfields mowed from the inside out rather than around and around avoid repeatedly mowing over or disturbing young.

**Fire and Controlled Burning.** Done correctly, burning on a periodic basis can improve the value of grass and brushland habitats for wildlife. Fire improves the quality of the habitat by removing accumulated dead plant material and litter that impede wildlife movement. Fire encourages the growth of valuable seed-producing weeds and succulent broadleaf forbs and stimulates legume germination through **scarification** (the breakdown of the tough seed coat surface) of the seed. Fire management also releases nutrients that create lush herbaceous growth necessary for high insect production. At the same time it produces bare ground for better small game movement and feeding. **Be careful.** *Not only is fire dangerous, but it does more harm than good if burns are done incorrectly or at the wrong time.* The role of fire in small game management has become accepted and well used in Kansas.

Small controlled burns are recommended for areas too steep for tillage or mowing. The burns will set back the existing vegetation and stimulate other valuable vegetation. Burns should be kept small and controlled with fire breaks plowed around the perimeters. Slow burns into the wind ignited during April are best. Always have enough people on hand at a burn to guard the fire break perimeters against fire jumping the break. More information on fire management can be obtained by contacting the KDWP.

**Development of Headquarters Areas.** Headquarters areas can be created by planting dense shrubby vegetation that is open underneath (good overhead cover and shady open ground below) and adjacent to several other types of good cover. Clump shrub plantings of wild plum, dogwoods, crabapples, or hawthorns are good for creating headquarters areas. The clumps should be one-quarter to one-half acre.

**Fencerow/Hedgerow and Travel Corridors.** The easiest way to provide escape cover and travel corridors for small game is the creation of shrubby fencerow/travel lane habitat. This type of habitat can be created through mowing practices or by planting soft mast-producing shrubs. This type of habitat can also be created next to forest lands to increase the amount of edge present. Hedgerow habitat should be 30 to 45 feet wide to provide travel corridors and resting areas for small game. Narrow fencerows (15 feet wide) have little protective value when they divide clean agricultural fields.

Hedgerow habitat can be created by not mowing or tilling the area adjacent to fences on a yearly basis. Briers and tree seedlings will naturally establish themselves along this border. Once these areas have become established, they can be placed in a rotational mowing or burning pattern so they are controlled and do not become too large for the equipment available for the mowing. Existing hedgerows can be thinned by cutting the large trees for firewood to encourage dense shrub growth. In any particular field, one-quarter of the fence line might be treated in any one year.

This type of habitat can be created without a fence at all, or it may be created by moving a mower's width away from an actual fence to allow for easier fence maintenance.

If shrubs and trees are to be planted in a fencerow, clumpy growth species like sumac, wild plum, bicolor lespedeza, dogwoods, crab apples, hawthorns, chokecherry, ash, and cedars should be used. They should be planted in dense clumps. These shrubby clumps will provide good winter food and escape cover.

**Root Pruning.** A highly recommended management practice to maintain shrubby fencerow or hedgerow habitat is pruning the roots of these plants along crop field edges. An incredible amount of fencerow/hedgerow habitat has been destroyed in recent years. The general belief has been that shading by trees and shrubs at crop field edges results in poor crop production along these edges. The reason crops are dwarfed at the edges of these fields is not due to shading; rather, it is due to competition for water and soil nutrients between the crops and the hedgerow vegetation. The effects of the hedgerow on crops can be eliminated by using a root plow to prune the lateral roots of hedgerow vegetation extending into the agricultural field. Root pruning will result in increased crop yields while not affecting the hardiness of the hedgerow vegetation.

Root pruning uses a root plow (single shank ripper) that will cut to a depth of 24 inches. The pruning is accomplished by making two or three passes with the plow, sinking it deeper into the soil with each pass. The plow is cut into the ground along the edge of the agricultural field (generally about 15 feet from the center of the fencerow or 1 foot toward the field from the drip-line of the trees). Root pruning can be done any time of the year so the work can be scheduled into farming plans according to available time. Root pruning is most easily done when the field next to the hedgerow is fallow. Pruning should be done every three to four years in Kansas, depending on the tree and shrub species present, soil types, and general growing conditions.

**WARNING.** *Root pruning involves working the soil deep enough that underground utility cables or pipelines could be destroyed. Be sure to check the area for such obstacles before starting a root-pruning operation. It would be wise to contact your local utility companies before beginning this operation.*

**Development of Roadside and Ditch Habitat.** These habitat types can become important travel corridors for many wildlife species. Roadsides and ditches should not be mowed every year if possible. Mowing should be done on a three- to five-year rotation. These areas can also be planted to native grasses and wildflowers or shrubs which increase their value to wildlife.

**Development of Odd Areas.** On most farms there are unused corners in fields or gullies that can be developed and

maintained in brushy or woody cover. Gullies, steep hillsides, and rock outcroppings should be allowed to naturally regenerate into brushy areas. These areas may also be allowed to regenerate into forest. Natural succession can be advanced by planting dogwoods, hawthorns, sumac, crab apples, wild plums, or chokecherry shrubs.

**Brushpiles for Wildlife.** Many species of wildlife need dense shelter for escape, resting, and loafing areas. One simple way to create this type of cover is to build some brushpiles. As with other types of cover development, brushpiles should be well distributed over the farm.

A properly built brushpile should have the large pieces of wood placed on the bottom of the pile (Figure 8). Four to five logs (5 to 10 inches in diameter) placed in a criss-crossed pattern are used to form the base of the brushpile. This creates spaces for the wildlife to use in the pile. Smaller limbs and twigs should be added to the top of these logs until a loose canopy has been formed. Properly constructed brushpiles should be 15 to 20 feet in diameter and 3 to 4 feet high. Do not pack the materials down. Loosely place the limbs and twigs to allow briars and other weedy vegetation to grow up through the pile. This allows for easier movement by wildlife while protecting them from flying predators.

Living brushpiles can also be created from cedar or oak trees using a "hinge cut" technique (Figure 9). A wedge-shaped chunk is cut from the tree to allow it to be pushed over while it is still partially intact at the cut area. This often results in the tree remaining alive on the top half while dying on the portion closest to the ground. This creates excellent winter and escape cover.

**Fall Plowing: Why Not?** A common problem for many farm wildlife species is the lack of adequate late winter food and cover. Fall plowing has become commonplace in Kansas and contributes to the problem of inadequate winter food and cover. By plowing under crop residues in the fall, the landowner creates an essentially barren piece of land. There is a tremendous amount of seed available to wildlife in harvested fields. This seed comes from the harvested grain and native plants. With mechanized harvesting as much as 5 to 10 percent of the crop may be left in the field. Any waste grains that would be available for wildlife are lost as they are incorporated into the soil. The crop residues that may have provided some cover are also lost as they are turned under the soil. The practice is detrimental to wildlife and contributes to soil erosion.

Farmers who fall plow erroneously believe that they are saving time and money by getting the soil worked in the fall for the following spring's planting. Studies have shown this practice costs the farmer in both effort and money. By plowing under the crop residue in the fall, many of the nutrients released by decomposing plant materials are leached from the soils before the next crops are able to use them. This results in increased fertilization needs for the

spring crops. Fall-plowed soils are also susceptible to erosion, losing valuable layers of the fertile topsoil. Finally, over the winter, the soils become compacted enough so they must be disturbed before planting, increasing time, labor, and fuel costs for the farmer.

Wildlife, the farmer, and the environment in general would greatly benefit if fall plowing was discontinued.

**Development of Grassland Borders.** Leave a 25- to 50-foot strip of unmowed grassland along a field or forest edge for nesting, particularly near brushy cover. Maintain this cover by mowing every three to five years. If it is not possible to leave the strip unmowed, mowing should be delayed until August when most nesting has been completed. If grassland habitat is not present along field borders or adjacent to strip-disked areas or food plots, 25- to 50-foot grassland strips can be planted using a mixture of big bluestem, little bluestem, Indiangrass, and switchgrass. (See Chapter 16 for information on establishing grasslands.)

**Development of Nesting Cover.** Oftentimes, nesting cover is a limiting factor for small game. Nesting cover should be developed next to woody or brushy cover. Nesting cover must be wide enough to be safe from predators. Thus, nesting cover should be developed in patches, not strips. A 200 × 200 foot square (acre) of nesting cover is more difficult for a fox or skunk to hunt in than is a 20 × 2,000 foot long, narrow strip.

A variety of mixtures can be planted for nesting cover. A mixture of switchgrass, ladino clover, and Korean lespedeza will provide adequate nesting and brood-rearing cover. If you plan on grazing or mowing the stand after the birds have raised their brood, a mixture of switchgrass, big bluestem, and indiangrass will provide good cover. (See Chapter 16 for information on establishing native prairie grasses.) Another suitable mixture is orchard grass, ladino clover, and Korean lespedeza. This mixture provides fair nesting cover but doubles as a deer or turkey food plot.



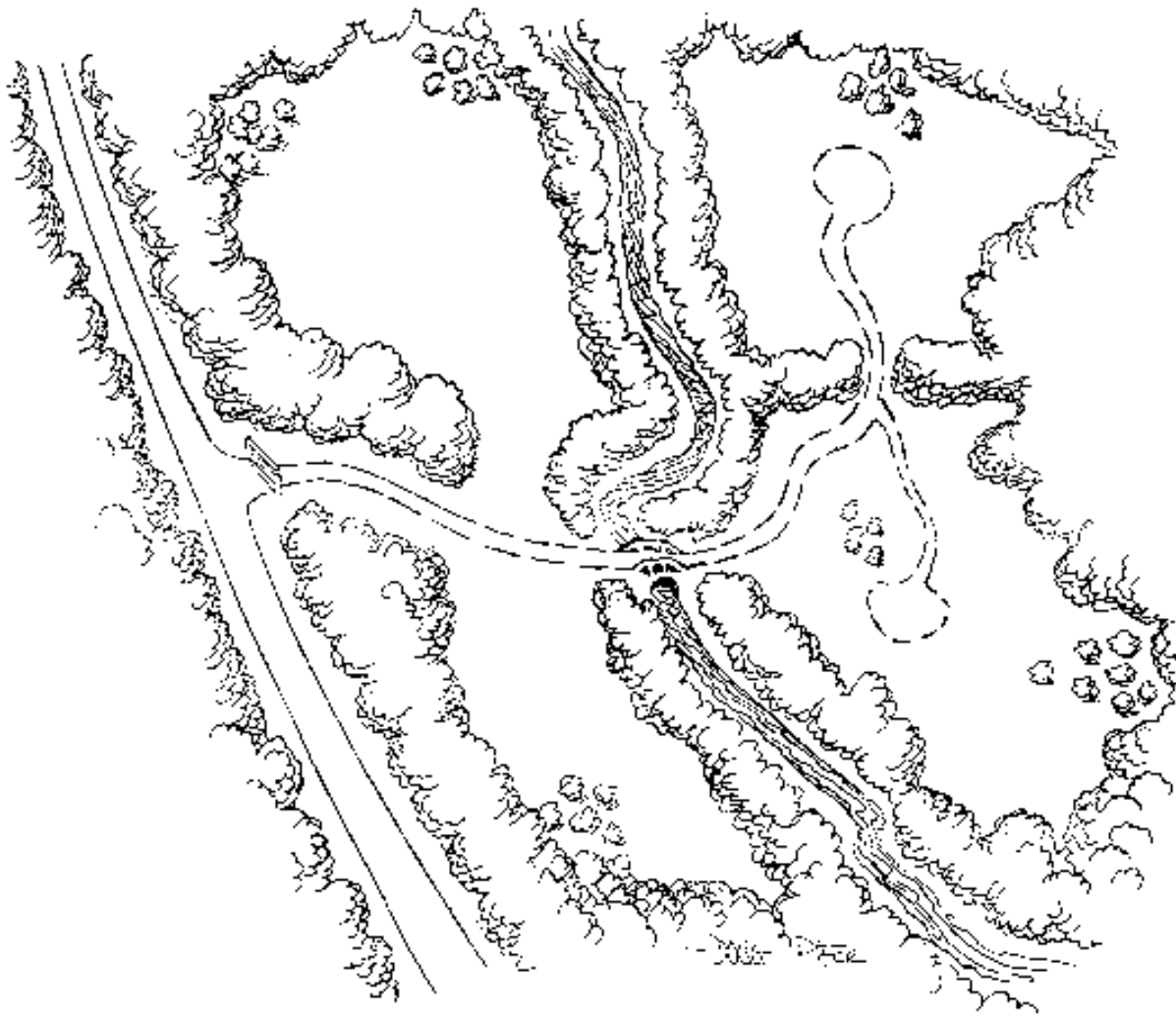

Figure 1. Clearcuts should be small and irregular, following the natural contours of the land. Timber should not be harvested next to streams or rivers, and travel corridors should connect other forested tracts.

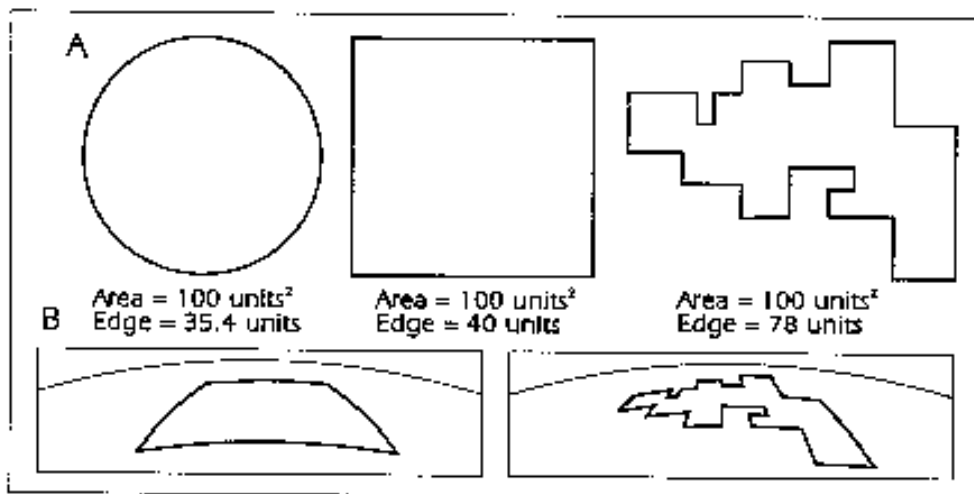

Figure 2. The effects of clearcut shape on the relationship between area and edge and aesthetic perspectives.

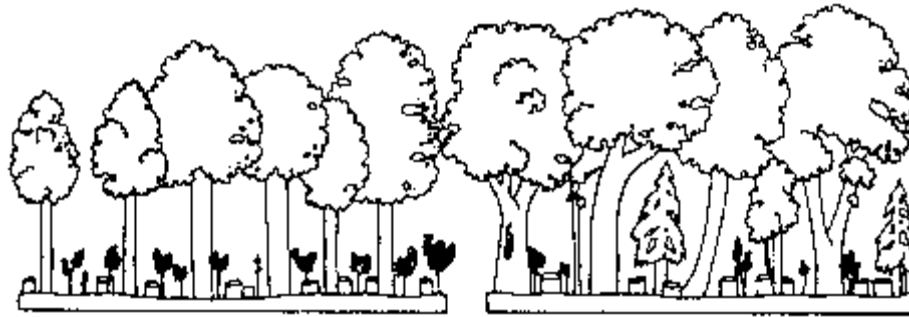

Figure 3. A selection cut should favor known mast-producing red and white oaks (left). Do not allow the forest to be high graded, a practice that removes only the best trees (right).

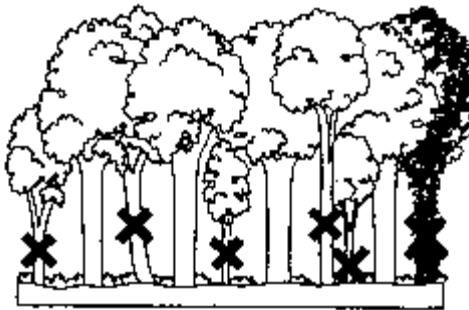

Figure 4. The poorest trees should be removed in a thinning operation.



Figure 5. Edge feathering involves removing 25 percent of the trees closest to the forest, 50 percent of the trees in the next region, and 75 percent of the trees closest to the open areas. This creates a type of edge known as gradual edge with low contrast (the best type for wildlife species).

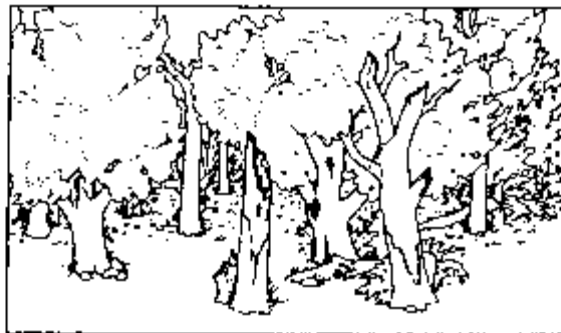

Figure 6. Old, mature to overmature forests with snags and wolf trees are beneficial to numerous wildlife species.



Figure 7. Features of dead and dying woody material used by wildlife.

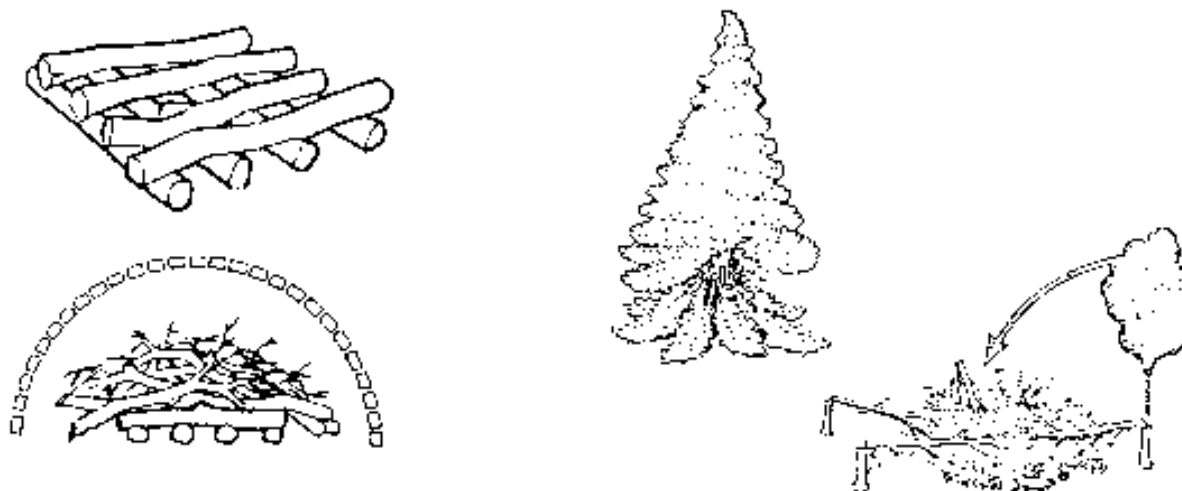

Figure 8. A brushpile should be made so the base is constructed of larger logs or rocks. The smaller limbs and twigs should be placed on the top of the pile.

Figure 9. An example of using a live cedar or juniper tree to create a "living brushpile" using a hinge cut in the trunk.

**Table 3. Quick reference to food, nesting plot, and woodland openings development.**

Species	Plants
<b>Northern Bobwhite</b>	
	millets
	milo
	clovers
	Korean lespedeza
	birdsfoot trefoil
	partridge pea
	wheat
	warm-season grass mixture
	soybeans
<b>Wild Turkey</b>	
	milo
	chufa
	clovers
	Korean lespedeza
	Kobe lespedeza
	alfalfa
	wheat
	orchard grass
	warm-season grass mixture
<b>White-Tailed Deer</b>	
	canola
	milo
	corn
	clovers
	alfalfa
	wheat
	warm-season grass mixture
	birdsfoot trefoil
<b>Cottontail Rabbit</b>	
	bluegrass
	warm season grass mixture
	Korean lespedeza
	clovers
<b>Mourning Dove</b>	
	sunflowers
	millets
	wheat



*Wildlife food plots should be long and linear. They should be placed next to good escape cover.*



*Most small game species require cover types based on soil disturbance. Strip disking is an excellent way to provide this type of cover. After the area is plowed, the soil should not be worked again for two to three years. This allows foxtail, ragweed, and other desirable food and cover plants the opportunity to flourish in these stripped areas.*



*Fencerow or field borders should be allowed to establish themselves into thick shrubby vegetation that will serve as travel lanes for small game. These areas should be approximately 20 to 40 feet wide. You can use root pruning to minimize any detrimental effects of these borders on crop production.*

**Table 4. Planting rates and dates for wildlife food or nesting plot plants.**

Species	Planting Dates	Seeding Rates (pounds per acre)	
<b>Annual Grains</b>			
Pearl millet	April, May, June	15 to 20	
Proso millet	May, June	15 to 20	
Japanese millet	May through August	10	
Milo	May, June	5 to 10	
Corn	April, May	10 to 15	
Sunflower	April	8	
Wheat	August, September, October	30 to 50—west 60 to 120—east	
<b>Legumes</b>			
Korean lespedeza	mid-Feb., March, April	10 to 25	
Birdsfoot trefoil	March, April	10 to 20	
August to mid-September	6 to 12		
Alfalfa	March, April	12 to 20	
August to mid-September	12 to 20		
Partridge pea	March, April	5 to 10	
<b>Clovers</b>			
Red	February to mid-April	8 to 12	
	August to mid-September	8 to 12	
Ladino	February to mid-April	1 to 3	
	August to mid-September	1 to 3	
<b>Grasses, Warm Season</b>			
		If used in mix	Pure stand
Big bluestem	February to May	6	15 PLS*
Little bluestem		4	12
Indiangrass		6	15
Switchgrass		3	25

Check SCS Technical Guides for seeding rates for your particular soil type.

Include a mixture of native forbs up to 1 pound per acre in native grass mixtures.

\*Pure Live Seed

**Table 5. Plant species used and seeding rates for mourning dove and northern bobwhite annual food plot mixtures.**

Mixture Number	Plant Species	Seeding Rates (pounds per acre)
1	milo	5
	soybean	10
	millet	5
2	corn	18
	soybean	10
	millet	5
3	Korean lespedeza	10
	millet	5
4	Korean lespedeza	10
	milo	5
5	Perodovick sunflower	10
	proso or browntop millet	15



*Controlled or prescribed burning is an excellent way to create small game habitat. Burning increases the number of food plants available to wildlife and increases the nutritional quality of those foods.*



*Landowners should not plow their fields in the fall. This leads to increased loss of top soil. It also eliminates any food or cover for wildlife.*

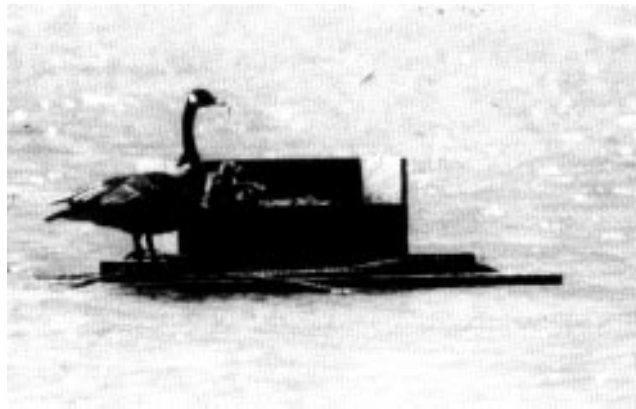

*Erecting artificial nesting sites (nest boxes) is one easy way to help many wildlife species like Canada geese, bluebirds, raccoons, squirrels, wood ducks and other nongame birds.*

## Questions for Chapter 20

1. Your primary goal is to manage wildlife in a forest, and a clearcut, selection cut, or thinning is prescribed. Describe all the activities that should be done to ensure that habitat is created or preserved for various wildlife species. For example, what size should the cutting be? Where should you cut? What should be cut or not cut? What should be done with tree tops?
2. Describe what types of habitat management prescriptions can be used to enhance small game wildlife populations on a farm.
3. Why shouldn't you fall plow?
4. How should nesting and escape cover for small game be created?

Name \_\_\_\_\_





## Appendix A

### Seed Sources

This list was compiled by the Cooperative Extension Service, Kansas State University, and the Department of Wildlife and Parks. This list is not complete and does not imply any endorsement or recommendation by the Cooperative Extension Service. Remember to buy certified seed and check the Pure Live Seed (PLS) of native grass seed before purchasing it.

When ordering “native” prairie or woodland flowers, grasses, shrubs, and trees, be sure to find out where the seed or plants originated. You should try not to use plants or seeds if they originate more than 200 miles south, 100 miles north, or 250 miles east or west of your location. The following sources may be consulted for further information on producers of tree and shrub seedlings, native grasses, wildflowers and wildlife specialty needs:

#### Sources for Wildflower Seeds

Applewood Seed Company  
5380 Vivian Street  
Arvada, CO 80002  
(303) 431-6283

Arrow Seed Company  
Box 722  
Broken Bow, NE 68822

Bluebird Nursery, Inc.  
P.O. Box 460, 521 Linden Street  
Clarkson, NE 68629  
(800) 356-9164

Horizon Seeds, Inc.  
1540 Cornhusker Highway, Box  
81823  
Lincoln, NE 68521

Kurt Bluemel, Inc.  
2740 Greene Lane  
Baldwin, MD 21013-9523  
(301) 557-7229

Lafayette Home Nursery, Inc.  
Lafayette, IL 61449  
(309) 995-3311

Mangelsdorf Seed Company  
Swan Avenue, P.O. Box 327  
St. Louis, MO 63166  
(314) 421-1415

Prairie Nursery  
P.O. Box 306  
Westfield, WI 53964  
(608) 296-3679

Prairie Ridge Nursery  
R.R. 2, 9738 Overland Road  
Mt. Horeb, WI 53572-2832  
(608) 437-5245

Sharp Brothers Seed Company  
Healy, KS 67850  
(316) 398-2231

#### Sources of Native Grass

Bamert Seed Company  
R.R. 2, Box 1120  
Muleshoe, TX 79347

DeLange Seed, Inc.  
P.O. Box 1853  
Lincoln, NE 68401

George Gates  
Bluestem Seed Company  
4045 Sommerset Drive  
Prairie Village, KS 66208

Greenbush Seed & Supply  
Box 661  
Hutchinson, KS 67501

Horizon Seeds, Inc.  
P.O. Box 81823  
Lincoln, NE 68501

Johnston's Seed Company  
411 West Chestnut  
Enid, OK 73701  
(405) 233-5800

Kauffman Seeds, Inc.  
Jerry Wyse  
408 North Poplar  
South Hutchinson, KS  
(800) 657-2583

Miller Seed Company  
P.O. Box 1853  
Lincoln, NE 68401

Pennington Seed of Greenfield  
Greenfield Industrial Park  
P.O. Box 338  
Greenfield, MO 65661  
(417) 637-5979

Sharp Brothers East  
R.R. 4  
Clinton, MO 64735

#### Sources of Native Grass (*continued*)

Sharp Brothers Seed Company  
Healy, KS 67850  
(316) 398-2231

Sommer Brothers Seed Company  
4700 Topeka Boulevard  
Topeka, KS 66609

Star Seed, Inc.  
128 South First  
Osborne, KS 67473

Valley Feed and Seed, Inc.  
1903 South Meridian  
Wichita, KS 67213  
(316) 942-2278



## Chapter 21

# Backyard Wildlife Habitat Management

*Thomas G. Barnes*

With just a little work and some good planning, you can transform your yard into a delightful place for you and your children to enjoy wildlife, even if you don't live on a farm. You can make your yard (anything less than 10 acres) into a wildlife sanctuary. The principles of wildlife management on farmland and prairies (Chapters 3, 4, 5, 6, and 7) apply to managing your yard for wildlife. The only difference is in the scale and scope of the management plans and practices. The key to attracting wildlife to your yard is to provide the necessary habitat for the wildlife you wish to attract (Figure 1).

Perhaps you are not convinced landscaping for wildlife is for you. Keep in mind, good landscaping and wildlife habitat development not only help wildlife survive and flourish but also provide additional benefits. One of the biggest benefits of properly landscaping your yard with wildlife in mind is an economic one. A properly landscaped yard full of trees, shrubs, grasses, and flowers can increase your property value by as much as 20 percent. In addition, a beautifully landscaped yard full of colorful trees, shrubs, grasses, and flowers will not be on the real estate market as long as other properties.

## WILDLIFE HABITAT COMPONENTS

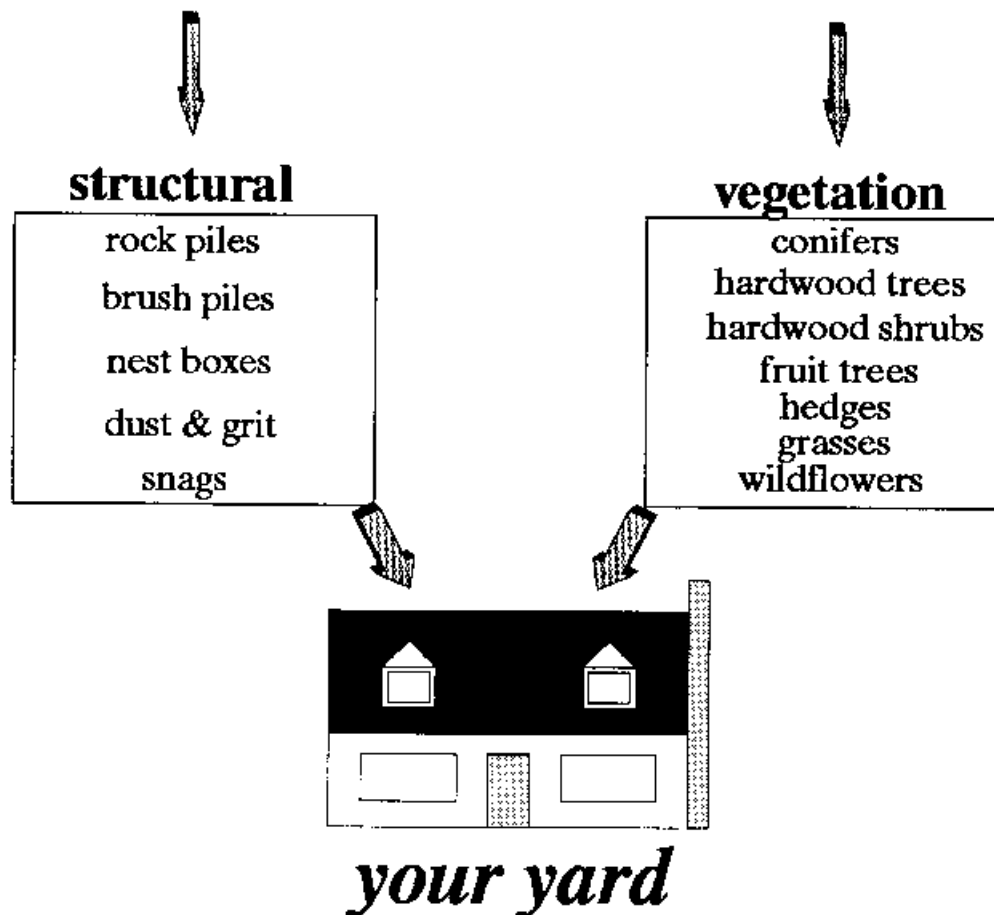

Figure 1. The various plant and structural characteristics that should be found in a backyard wildlife habitat plan.

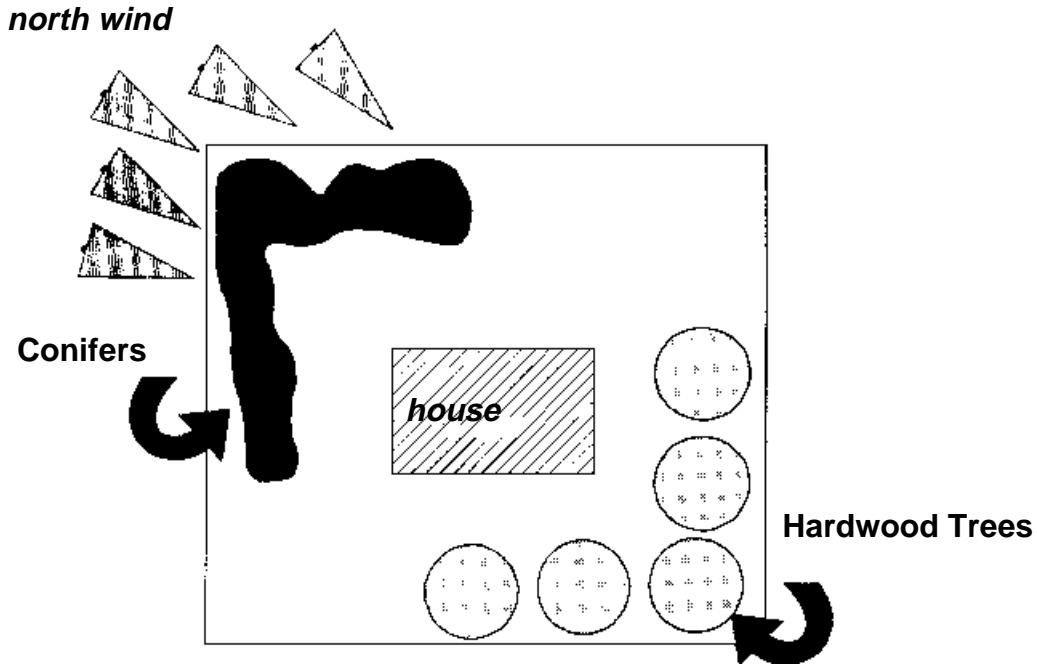

Figure 2. Planting trees on the south and east sides of the home and conifers on the north and northwest sides of the home will result in less energy consumption.

Another economic advantage is a reduction in energy used to heat and cool your house. As energy prices continue to increase, most of us are looking for ways to lower monthly heating and cooling bills. Planting conifers on the north and west sides of the house will reduce the cooling effects of harsh winter winds while providing shelter for wintering songbirds (Figure 2). Planting hardwoods on the south side of the home will reduce air-conditioning costs by creating shade during the summer. As fall approaches, these trees drop their leaves and reduce winter heating costs by allowing the home to absorb the sun's rays.

In addition to economic benefits, a properly landscaped yard will reduce the amount of yard work you need to do. Do you have an area in your yard that is a little moist and shaded, where nothing seems to grow except weeds? Problem areas like these can be planted to wildflowers (Figures 3 and 4). Other problem areas can be landscaped and made virtually maintenance-free, resulting in less mowing and work for you.

Mosquitoes, grasshoppers, and other insects can become a nuisance or pest around your home or in your garden. Many homeowners are reluctant to spray chemicals to control various insect pests. By providing the right type

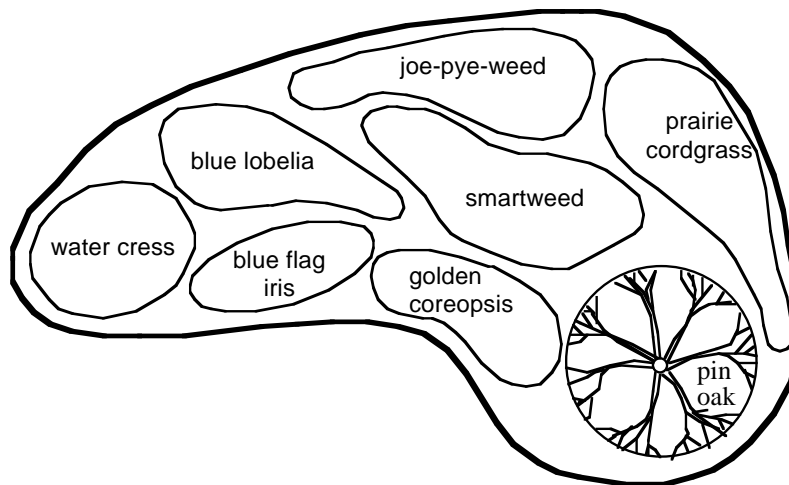

Figure 3. A small native wildflower garden adapted to wet soil types.

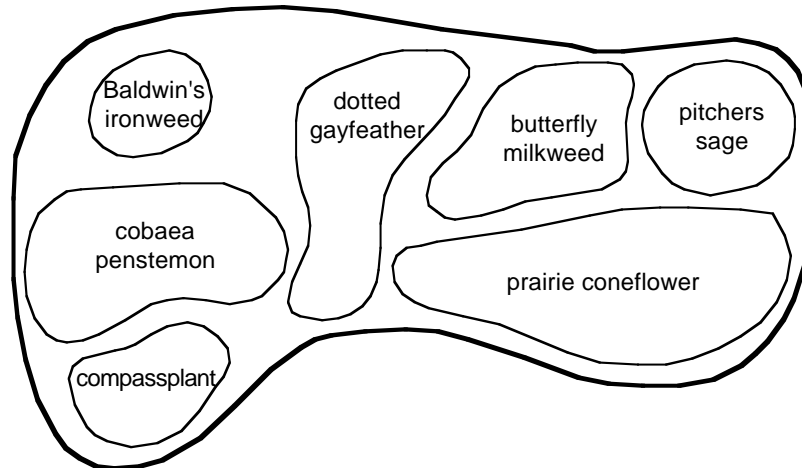

Figure 4. A small native wildflower garden adapted to dry or upland sites.

of habitat in a landscaped backyard, you can provide some natural insect control. Insect-eating predators like tree swallows, purple martins, bluebirds, dragonflies, and bats can be attracted to a backyard. Many people dislike the idea of having bats in their yard until they discover that a single little brown bat can eat up to 600 mosquitoes in an hour. You can attract bats to your backyard by placing bat houses in trees or on buildings close to streams or water.

Do you remember when you were a child and everything seemed new, fresh, and exciting? You would explore the neighborhood and discover snakes, trees, flowers, and birds. A young and growing mind will thrive in an environment where wildlife and nature abound. A properly landscaped yard can expose your children to the wonders of nature. In addition, it may allow you to rediscover some of the same things that excited you when you were a child. If you allow your children to help plant flowers, trees, shrubs, and grasses for wildlife, their experiences can be even more meaningful.

Are you a birdwatcher or photographer? Imagine the opportunities that exist if your yard is regularly visited by butterflies, cardinals, goldfinches, hummingbirds, fox squirrels, and rabbits. If you are a birdwatcher, it is possible to attract a wide variety of birds to your yard. Creating a landscaped yard for wildlife also provides natural beauty. Many of the most desirable and beautiful landscaping plants, such as flowering dogwood, flowering crab apples, and wildflowers, provide excellent benefits for wildlife. In addition, can you think of a better way to relax and relieve stress by looking out over this natural beauty?

Hopefully, you are now convinced that a yard landscaped for wildlife is for you. How do you begin to transform that suburban monoculture into a diverse landscape teeming with wildlife? Where do you go from here? The key to successfully transforming your yard is to develop and implement a plan of action.

Before you can take this first step, you must understand

some of the basic principles of managing habitat for wildlife. Many people do not understand that the health of wildlife populations is tied to the health of their habitats. You can improve your chances of attracting wildlife to your backyard by following some basic principles and by providing the essentials of wildlife habitat: food, shelter, space, and water. (These principles are discussed in detail in Chapter 4.)

The difference between managing a farm and a backyard for wildlife is one of size. When managing for wildlife in the backyard, you must consider habitat as individual plants or small groups of plants. Thus, a brief discussion of habitat for backyard wildlife is appropriate.

### ***Creating Usable Habit: Providing Cover, Food, Water, and Space***

#### **Cover and Food**

Animals require protective cover or shelter for protection from adverse weather, hiding from predators, nesting and raising young, sleeping or resting, and traveling. Shelter can come in many forms including trees, shrubs, grasses, flowers, or structures like brush or rock piles, nest boxes, and hollow trees.

All animals get their nutrients for survival from plants and other animals. Ideally, a backyard plan would use a variety of native plants that bear flowers and fruit at various times throughout the growing season to supply year-round food. This variety of vegetation will attract a wide variety of small animals which serve as a food supply for larger animals.

Some types and varieties of plants that are used to attract backyard wildlife are found in Table 1. The following brief discussion may give you some ideas on how the different groups of plants benefit backyard wildlife.

Conifers, also called evergreens, provide winter shelter

**Table 1. List of plants suitable for backyard wildlife plantings in Kansas.**

<p><b>Tall Hardwood Trees</b>                      Bitternut hickory                      Black walnut                      Bur oak                      Chinkapin oak                      Cottonwood                      Pecan                      Pin oak                      Red oak                      Shagbark hickory                      Shumard oak                      Silver maple                      Sugar maple                      Sycamore                      White oak                      Willow</p> <p><b>Small Hardwood Trees</b>                      Black cherry                      Crabapple                      Flowering dogwood                      Hawthorns                      Mulberry                      Persimmon                      Redbud                      Western buckeye</p> <p><b>Evergreen Trees</b>                      Austrian pine                      Deciduous holly                      Eastern red cedar                      Ponderosa pine                      Rocky mountain juniper                      Scotch pine</p>	<p><b>Shrubs</b>                      Autumn olive                      Butterfly bush                      Buttonbush                      Chokecherry                      Common lilac                      Cotoneaster                      Elderberry                      Fragrant sumac                      Golden current                      Gooseberry                      Honeysuckle                      Nanking cherry                      Sandhill plum</p> <p><b>Shrubs Useful for Hedges</b>                      American plum                      Box honeysuckle                      Holly                      Juniper                      Privet                      Riverbank grape                      Yew</p> <p><b>Grasses and Legumes</b>                      Alfalfa                      Big bluestem                      Birdsfoot trefoil                      Eastern gamma                      Indiangrass                      Ladino clover                      Little bluestem                      Prairie clover                      Prairie cordgrass                      Sideoats gramma                      Switchgrass</p>	<p><b>Wildflowers</b>                      Asters                      Beard tongues                      Black-eyed susan                      Blazing stars                      Butterfly milkweed                      Common Yarrow                      Common milkweed                      Coneflowers                      Coreopsis                      Gentians                      Goldenrods                      Irises                      Joe Pye-weed                      Phlox                      Pitcher sage                      Queen Anne’s Lace                      Sunflowers                      Verbenas                      Violets</p>
--	--	--

and escape cover for a variety of bird species because these trees do not drop their needles during the winter. In addition, many birds use conifers for nesting because of the dense nature of the needles. Many wildlife species also use the sap, needles, twigs, buds, and seeds for food. Native conifer species beneficial to wildlife that grow well in Kansas include Rocky Mountain juniper, Austrian pine, ponderosa pine, and eastern red cedar.

Other plants that you should consider in a backyard wildlife habitat plan are hardwood mast- or nut-producing trees. These trees are long-term wildlife investments because they can live up to several hundred years and produce acorns and other nuts that wildlife need for fall and winter food. As these trees age, they contain natural cavities

that numerous species of wildlife (fox squirrels, raccoon, and a variety of birds) use as a source of shelter. There are numerous native trees that can benefit wildlife. Some of the best species to consider are oaks, maples, black walnut, hackberry, pecan, and black cherry.

Some of the most beautiful landscaping plants that benefit wildlife are the soft mast-producing trees and shrubs. These plants produce fruits and berries during the summer and fall. Berry- and fruit-producing plants attract a wide variety of wildlife species because of their food value. Soft mast-producing plants provide nesting, escape, and winter cover for some wildlife species because they can form dense thickets. Particularly attractive soft-mast-producing trees and shrubs native to Kansas include

serviceberry, flowering dogwood, hawthorns, plum, mulberry, and blackberry. Homeowners should also consider planting a grape or cherry patch as a food source for wildlife.

You should consider planting native grasses and legumes to provide habitat for ground-nesting birds. This vegetation also provides food for plant-eating mammals like cottontail rabbits and woodchucks. The seeds these plants produce are excellent food for a variety of bird species. The best approach to planting grasses and legumes is to plant a mixture of big and little bluestem, switchgrass, Indiangrass, sideoats gramma, and numerous clovers and wildflowers.

The final selection of plants should be flowers. A butterfly, moth, and hummingbird garden can quickly become an outstanding feature of your yard (Figure 5). Consider planting native wildflowers which are adapted to the area. These plants provide food for caterpillars and nectar for adult butterflies, hummingbirds, and orioles. The seeds these flowers produce also are an excellent source of winter food for numerous bird species. Wildflowers particularly attractive to wildlife include any of the milkweeds, asters or phlox, black- and brown-eyed susans, white or purple bergamot, marigold, gayfeathers, goldenrods, and primrose.

Numerous domestic or cultivated flowers are also attractive to butterflies, moths, and hummingbirds. Some of the species beneficial to butterflies include New Jersey tea, azaleas, butterfly bush, buckeyes, impatiens, marigolds, sunflowers, petunias, zinnia, chrysanthemums, alyssum, primroses, verbena, coreopsis, daisies, gaillardia, sweet william, and yarrow. Caterpillars may use snapdragons, plantain, asters, milkweeds, Queen Anne's lace, and numerous legumes.

When deciding on which plants to use in your plan, be sure to select plants native to Kansas. These plants are better adapted to this area, require less maintenance, and resist the extremes of cold, heat, drought, and wetness. Never remove plants from the wild because they generally do not survive when transplanted. In addition, removal of wild plants could harm natural plant communities.

There are several useful guides for helping you select plant varieties that do best in Kansas. You can obtain free information about habitat plantings from your local Cooperative Extension Service office.

You should always buy planting stock from reputable nurseries that can guarantee plants were not taken from the wild. A list of seed sources specializing in plant materials is provided in Chapter 20, Appendix A.

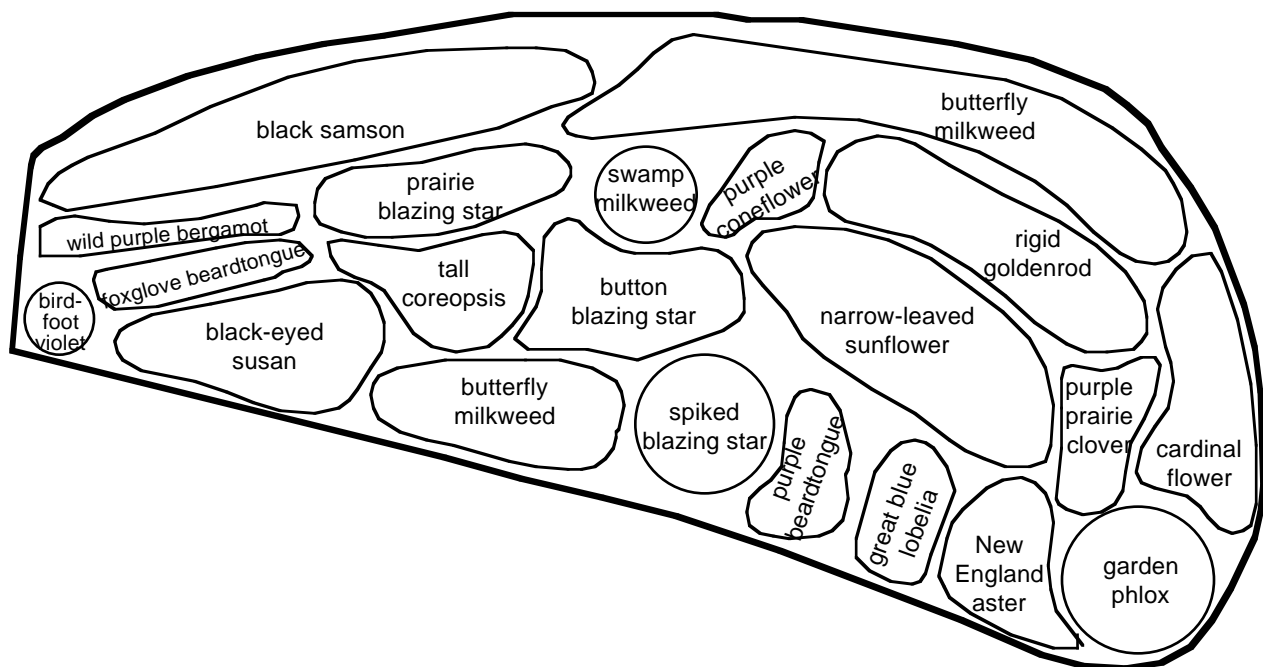

Figure 5. A hummingbird and butterfly wildflower garden adapted to full sun sites.

Once you have selected the plants, remember that structural non-living habitat components also are necessary to attract wildlife to your backyard. Consider building nest boxes or a rock/brushpile. In addition to helping birds, nest boxes benefit such species as fox squirrels and white-footed mice. Ground squirrels and shrews use brushpiles for protection and shelter.

If there is a dead tree present, do not destroy it if it does not pose a hazard to people. Dead trees are called **snags**. All snags are not hazards nor are they intrinsically ugly. Snags provide nesting sites, perching sites, and food for bluebirds, woodpeckers, flying squirrels, and a whole host of reptiles, mammals, and birds.

If you are interested in attracting turtles, consider placing logs or rocks at the edge of a pond to allow the animals a place to bask in the sun. By leaving any stumps, rotting logs, or wooden fences or rails, you will create basking habitats for insect and pest-eating lizards and snakes.

**Water**

Fresh water is essential for wildlife and often is one of the factors limiting the presence of wildlife in backyards. The importance of water for wildlife in a backyard situation cannot be overemphasized. A dirty or thirsty bird is not a happy bird because birds need water for bathing and drinking. Shallow ponds also foster the growth of aquatic

insects which are relished as a food source by many birds, amphibians, and reptiles. Water is also necessary for temperature regulation, breathing, and reproduction of numerous reptiles and amphibians.

Providing water for wildlife in a backyard situation is an art unto itself and is perhaps the most challenging aspect of backyard landscaping for wildlife. When planning a pond or birdbath, consider that dripping or flowing water is more attractive to wildlife than still water. If this is not possible, shallow water is preferred over deep water by most wildlife species. A fine spraying mist of water is very attractive to hummingbirds. Shallow bird baths, clay trays filled with water, or puddles with a sandy or muddy bottom will suffice as a source of water for butterflies. An innovative way to provide water for birds and butterflies is to place a child's shallow plastic swimming pool at the base of a drain spout.

Water for birds should be made available in shallow pools or ponds ranging in depth from 1/2 to 3 inches deep. The sides of the pool should be **very** gradually sloping. At least one edge around the pond should be kept clear of any vegetation and made available as a loafing area. This allows an unobstructed view and perching area for cautious birds. Other areas surrounding the pond should be landscaped with plants to provide a secluded watering place for other animals. You can plant shrubs, grasses, legumes, and wildflowers around the pond which also will provide a food source for some animals. If you plan on purchasing a

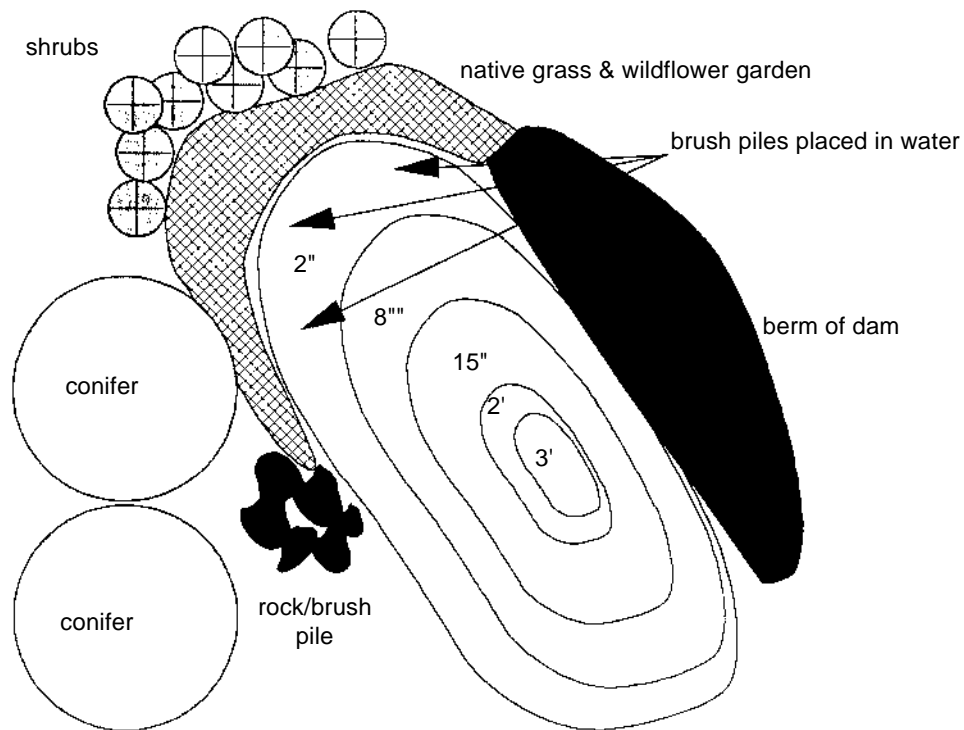

Figure 6. An example of a small backyard frog pond.



commercial bird bath, be sure it does not have steep sides and is not too deep for birds to use.

If you have an exceptionally large backyard and wish to attract a wide variety of frogs, toads, salamanders, turtles, and other wildlife, a small "frog pond" can be constructed (Figure 6). The pond can be 8 to 10 feet across and several inches to 2 feet deep. Be sure the pond is within reach of your garden hose or other reliable source of fresh water. Try to gently slope the basin to provide a variety of depths for various wildlife species. You should also consider placing brush, rocks, or logs in the shallow end for basking sites and landscape around the perimeter with native wildflowers.

More information on creating a backyard pond can be obtained by writing to the National Institute for Urban Wildlife, 10921 Trotting Ridge Way, Columbia, MD 21044. Request a copy of *Urban Wildlife Manager's Notebook 2, A Simple Backyard Pond*.

The National Pond Society publishes monthly the *Pondscapes Magazine*. Pondscapes deals exclusively with the needs of backyard pond keepers of ornamental ponds. Additional information and subscriptions are available from: Pond Publishing Company  
P.O. Box 449  
Acworth, GA 30101 or call (404) 975-0277.

## Space

All animals have unique space or territorial needs in order to mate and rear their young. For example, bluebirds need about 5 acres per pair, whereas ground squirrels have a home range of approximately 100 yards. By understanding the space needs of wildlife, you can anticipate the numbers of wildlife that will be attracted to your property. Animal space requirements may be less if food, water, and cover resources are substantially increased on your property.

In addition to understanding the food, cover, water, and space needs of wildlife, you also need to understand that basic habitat components must be properly arranged to maximize their benefit to wildlife. A food plot with no cover nearby or a food plot exposed to the prevailing winds serves little purpose and may even be detrimental by forcing wildlife to feed in unprotected areas (Figure 7).

Remember to keep cover (conifers and shrubs) on the north and northwest sides of the property to protect wildlife from harsh winter winds. Additional cover, food, and water should be developed inside the outer windbreak on your property boundaries. If possible, do not plant trees, shrubs, and flowers in straight lines. Be creative in deciding where to place various plantings. Remember, providing a variety of habitat attributes, both in plant species and structural components, in the proper arrangement will increase your chances of attracting wildlife to your backyard.

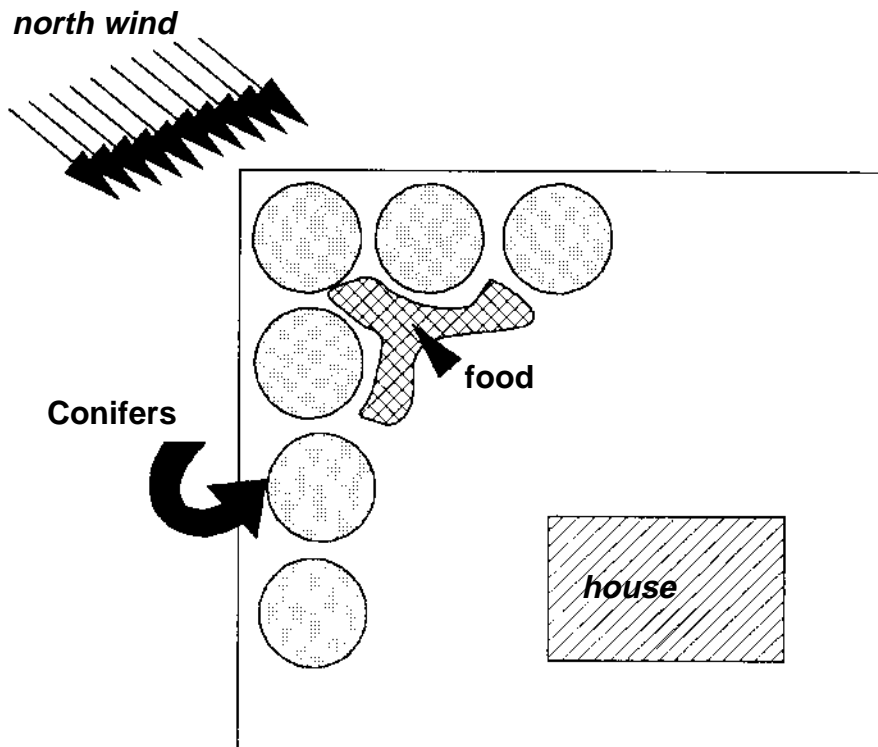

Figure 7. Correct arrangement of food and cover in a backyard wildlife plan. Note that the food source is protected from the prevailing winds by conifers.

You also should consider one other thing before beginning to devise a backyard habitat plan: what to do about pest and nuisance animals. There are numerous species of wildlife you will wish to attract to your yard, but what about those species you are not trying to attract but show up anyway? For example, if you plant various flowers to attract hummingbirds and butterflies, you also will be attracting wasps, honeybees, and other insects. You will need to determine your threshold for tolerating squirrels visiting bird feeders, ground squirrels digging holes around sidewalks and foundations, moles tunneling through yards, woodpeckers drumming on the house, or snakes found in the basement.

During the preplanning stage, consider areas where animal damage problems may arise. You can then install fences or other screening devices to prevent any damage from occurring. For example, you may want to install a fence around your garden to keep rabbits and woodchucks from destroying vegetable plantings. You also may wish to screen any openings in buildings that may be used by birds, bats, or squirrels. Contact your local county Extension office for publications on handling many of the common urban pest and nuisance animals. These free publications discuss what options a homeowner has for preventing and reducing animal damage problems.

### *Planning for Success*

Once you understand the basic ideas of habitat development, you are ready to begin developing a plan of action. Begin the planning process by evaluating what habitat and wildlife is already present on your own and adjoining properties. By examining neighboring yards, you can determine how your plan can complement the habitat that already exists. This is important because the animals attracted to your yard will come from the larger surrounding landscape. If you are unfamiliar with the species of wildlife visiting your yard, purchase a field guide directed toward those species of animals.

Make a record of what trees, shrubs, flowers, and other plants are present on your property and those surrounding it. What animals are present? What plants are those species of wildlife using? What are the blooming dates of the trees, shrubs, and flowers? When are various seeds, berries, and nuts available? What trees or shrubs are providing cover? Knowing what is already present will give you an idea of what is lacking in the habitat.

Do not consider only the plants present on the property. Do you have any ponds or streams on or close to your yard? What buildings, power lines, sidewalks, driveways, septic tanks or lines are present? You will need to work around these immovable objects.

After completing your habitat inventory, you need to ask yourself some important questions, such as how much

time and money are you willing to contribute to this project? Don't try to do too much at one time. You may want to spread your activities over several years with a budget that coincides with the development schedule. You also must ask yourself, "What kinds of animals can I attract to my backyard?" Do you want to attract birds, mammals, reptiles, amphibians, or butterflies? Many homeowners want to attract as many different wildlife species as possible, or they want to attract a specific group of species such as birds.

At this point, you are probably thinking about what to plant. Before you consider this step, you need to draw a map of your property (Figure 8). The best planning map will be one drawn to scale on graph paper which identifies all existing structures, including buildings, power lines, buried cables, trees, flower beds, gardens, sidewalks and driveways, and particular views that you enjoy or any you wish to screen out.

On the planning map be sure to identify any special conditions that may require different considerations. These areas may include shady or sunny areas, low or wet areas, poorly drained areas, sandy soils, or areas of native vegetation you wish to save.

You may want to contact your local county Extension office to have your soils tested to determine if these sites and other soils on the property have nutritional deficiencies. This will also provide information on which species of vegetation can be planted, and how those plants will need to be maintained.

You are now ready to develop a planting plan to meet your specific objectives. Remember to consider food, water, and cover requirements when selecting plant species. Also, remember it is better to use a multi-layered vegetation approach to landscaping for wildlife. Such an approach uses conifers, hardwood trees, soft mast-producing trees and shrubs, grasses and legumes, and native wildflowers for food and cover, all of which will attract a wide diversity of wildlife species.

Once you have selected the various plants and structural habitat components you wish to have in the backyard, sketch them on your map. Be sure to draw trees and shrubs to scale for their mature size. You are now ready to implement your plan. More information on planting native wildflowers is included at the end of this chapter.

Once you have begun this adventure, keep records, including:

- what flowers, trees, shrubs or grasses you planted,
- when you planted them,
- where you planted them, and
- what expenses you incurred.

After planting, your next job is to maintain your plantings. For example, new shrub and tree plantings can be maintained weed-free by applying a 4- to 6-inch bark mulch layer. You should also consider when you will water,

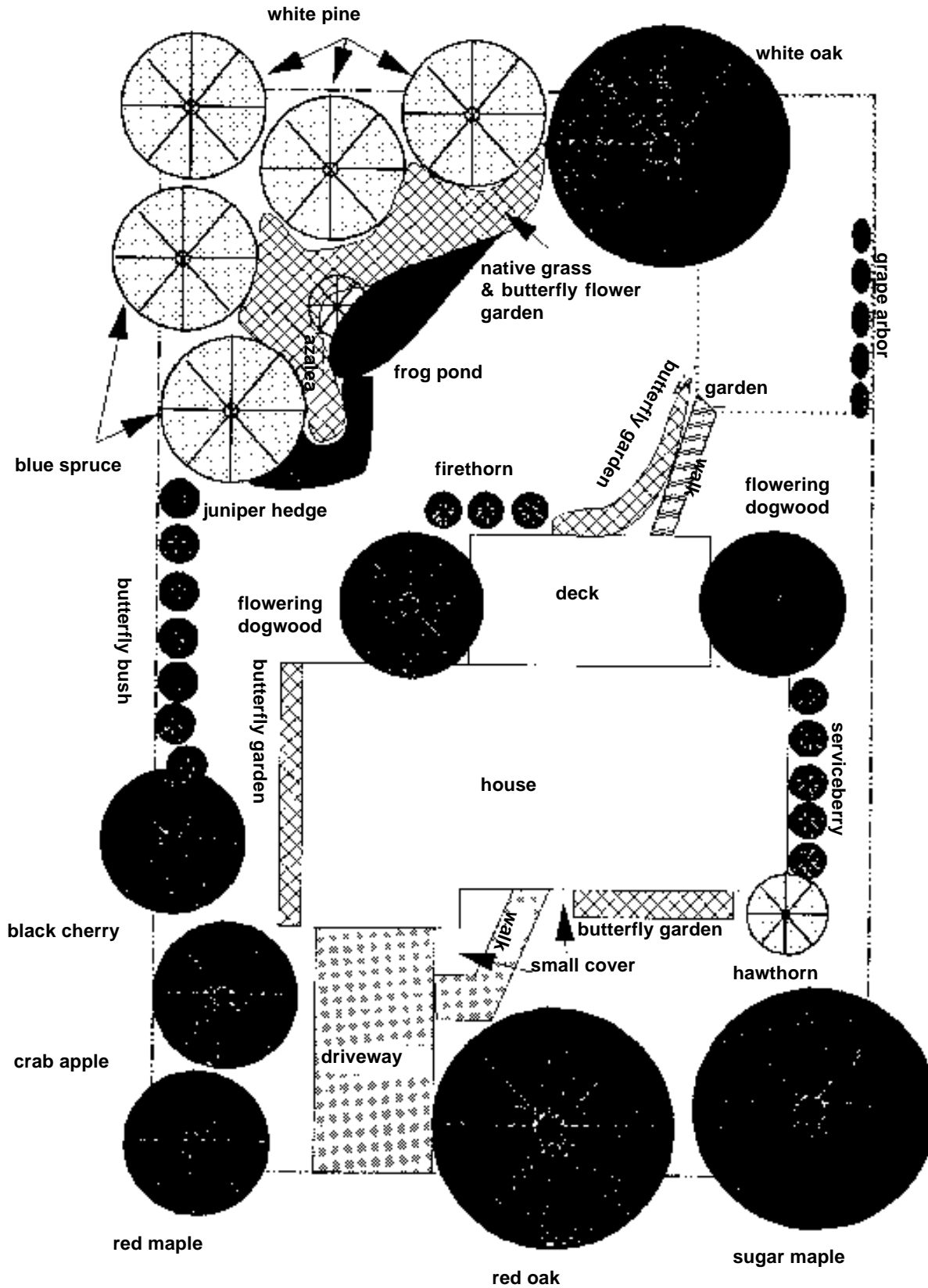

Figure 8. A an example of a backyard wildlife habitat plan for an 80- x 140-foot yard.

fertilize, and weed to help plants get established. Some unwanted plants and animals may have to be removed from time to time. Some trees and shrubs will need to be pruned. Contact your local county Extension office for assistance with maintaining your plantings.

The final step is to enjoy the natural beauty that surrounds you. Do not expect immediate results. It may take up to four or five years for some plants to become established. Be patient if wildlife are not immediately attracted to your yard. When the habitat develops, the wildlife will eventually be there. The kinds and numbers of wildlife that visit your backyard will vary greatly depending on your location, size of area, amount of habitat development, and a variety of other factors. By watching and enjoying even the small things, your backyard can become a place of enjoyment and adventure for young and old alike.

### ***Tips and Pointers on Planting Native Wildflowers and Grasses***

Should you use seeds or transplants? A number of factors, including size of area to be planted and cost and desired flowering time, will determine whether you use seeds or transplants. Generally, seeds are probably better suited for larger, naturalized prairie plantings, while transplants are suited for smaller landscaped plantings and the home garden. Transplants are also desirable and more practical in small areas (less than 2,500 square feet).

Many native wildflowers and grasses can be grown successfully from seed. Others are slow growing and do better when transplants are used. Generally, most species begin flowering the second or third year, so if quick results are necessary, transplants would be more desirable.

One drawback of using transplants is cost. Wildflower seeds range in price from \$35 to \$200 per pound. Although transplants are considerably more expensive, their survival is usually much better than plants grown by seed germination.

### **Site Selection**

Native wildflowers grow in a variety of habitats, and you should try to match them with the natural growing conditions in your yard. Woodland wildflowers prefer well-drained, humus-rich soil and full, filtered, or bright shade. They also benefit from the fall leaf drop. The prairie or sun-loving wildflowers prefer well-drained soil and direct sunlight for at least four to six hours each day. Most wildflowers perform well in soil with a pH of 6.0.

### **Planting Dates**

Wildflower seeds can be sown in the spring or fall. A fall planting allows seeds to overwinter in the soil. This may help break seed dormancy and improve germination of perennial species. If you decide on a fall planting, plant late enough (late October through November) to prevent the

seeds from germinating until spring. If you plant during the spring, wait until the danger of a hard frost has passed (late April through early May). You can also plant the seeds during the summer if you can water on a regular basis.

Some seeds require cold stratification to germinate. For these species, place the seeds in a Ziploc bag with an equal amount of moistened (not wet) sand and store in the refrigerator at 38° to 40°F for four to 12 weeks. Open the bag periodically to check for mold (an indication it is too wet). Remove the bag from the refrigerator 24 hours before planting the seed.

### **Site Preparation**

Proper site preparation will reduce weeds and increase your chances of good seed germination. The site should be prepared in the fall before a spring planting. For larger areas, existing vegetation can be removed by fall plowing. If you must prepare the site in the spring, disk the plot every two weeks before planting. If the area is subject to erosion or if fescue grass is present, vegetation can be controlled by two herbicide applications, once in the fall and once in the spring, or two weeks apart in the spring followed by disking every two weeks before planting. Application rates for a herbicide such as Roundup® are 1 pint to 1 quart in 10 gallons of water plus surfactant per acre. The more thorough the advance preparation, the fewer problems you will have with weeds later on.

### **Seeding Rates**

Seeding rates vary depending on what species you are using and the viability of the seeds. The National Wildflower Research Center recommends a rate of 12 pure live seed (PLS) per square foot. In a garden, four to six seeds per square foot is usually sufficient. If you are planting in the fall, increase the seeding rate because some seeds will be lost to animals, erosion, etc.

Sow the seed on a windless day to prevent possible seed drift. Seeds can be mixed with moistened sand to help in broadcasting. After sowing, seeds should be covered by raking and rolling to firm the soil. Water thoroughly and keep evenly moist until the plants become well-established. Using mulch in the fall will help retain moisture and prevent overwinter loss. For areas less than 2 acres, seeds can be hand broadcast. Areas greater than 2 acres are impractical for hand broadcasting and should be mechanically seeded.

### **Transplanting**

Bare root seedlings should be transplanted in the late fall or early spring while plants are still dormant. Till the soil deep enough until digging is easy. Dig individual holes deep enough so the terminal bud is placed about an inch below the soil surface without bending or curling the roots. Potted plants can be transplanted anytime.

## Weed Control

Because most prairie plants spend the first year establishing their root systems, they do not produce much above-ground growth. As a result, a naturalized planting often resembles a weed patch the first year. In a large planting, weeds should be controlled by mowing to a height of 6 to 8 inches two or three times during the summer. On small areas, hand pulling may be necessary (be sure you know which ones are weeds). Most of the weeds will probably be annuals. Perennial weeds can be controlled by careful application of a herbicide.

## Maintenance

A naturalized planting will begin to resemble a prairie by the second year. Mowing in late June may still be necessary to control annual weeds. Ideally, a prairie planting should be burned every three to four years beginning the third year. Burning should be done in the early spring (before April 15) and only after necessary permits have been obtained. Spot applications of herbicides on invading woody plants can be done where burning is not feasible.

By the fourth year a naturalized prairie planting should be well-established and will pretty much take care of itself for years to come. More information on growing wildflowers and establishing native prairie can be obtained by consulting the following books:

*Growing and Propagating Wildflowers* (H.R. Phillips), published in 1985 by the University of North Carolina Press, Chapel Hill, North Carolina, 331 pages.

*Prairie Propagation Handbook* (H.W. Rock), published in 1977 by Wehr Nature Center, Whitnall Park, Wisconsin, 67 pages.

*The Prairie Garden* (R.J. Smith and B.S. Smith), published in 1980 by the University of Wisconsin Press, Madison, Wisconsin, 219 pages.

*Directory to Resources on Wildflower Propagation* (G.A. Sullivan and R.H. Daley), published in 1981 by the Missouri Botanical Garden for the National Council of State Garden Clubs, Inc., St. Louis, Missouri, 331 pages.

Where trade names are used, no endorsement is intended, nor criticism implied of similar products not named.



## Questions for Chapter 21

1. What are the benefits of landscaping your yard for wildlife?
2. Why should you use a multi-layered vegetation approach in developing your backyard wildlife management plan?
3. Describe how conifers, hardwood trees, berry- and fruit-producing shrubs, native warm-season grasses, and wildflowers benefit wildlife in the backyard.
4. Why should you select plants native to Kansas for your backyard wildlife plan?
5. How can you provide wildlife cover in the backyard?





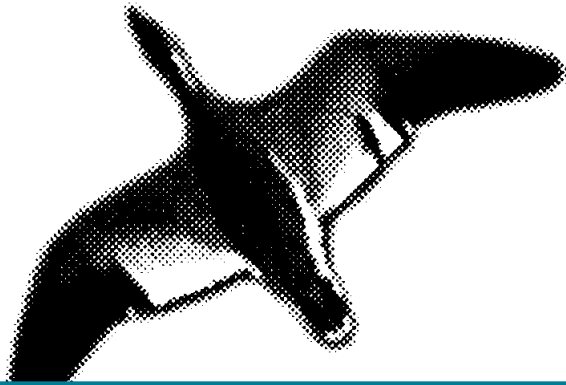

PRIVATE  
LANDS

SECTION IV  
ECONOMICS

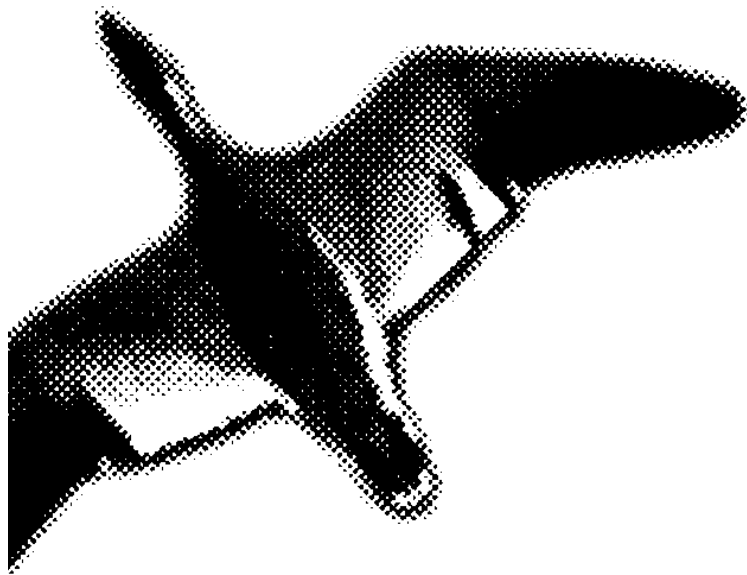

WILDLIFE  
MANAGEMENT

A Technical Manual  
&  
Correspondence  
Course

## Chapter 22

# Economic Returns of Wildlife to the Landowner

*Jeff Powell and Richard Olsen  
modified by Edward Kozicky*

## *Economic Returns from Wildlife*

Private land in Kansas produces 95 percent of game taken by hunting and contains 85 percent of the wildlife habitat that is economically feasible to improve. The increasing human population and decreasing work time means increasing recreation pressure. The continuation of public hunting and fishing will depend largely on the private landowner and whether or not he can be convinced that wildlife and hunting on his lands are beneficial to him and the general public. Increased aid, both technical and monetary, is needed from local and state government agencies and the general public to convince the private landowner.

Wildlife belongs to everyone, but only the landowner can produce it. Whether wildlife becomes scarce or abundant in an area depends on the attitudes and practices of the landowner. Furthermore, his practices can largely determine which wildlife species are present. Unfortunately, given today's economic facts of life which dictate maximum returns from the land, wildlife is too often written off as being economically neutral at best, or worse—an economic liability. But the question arises: are there ways wildlife can be—or is—an economic benefit to the landowner?

Actually there are a number of ways wildlife can benefit the landowner in an economic sense. Benefits can be a direct monetary return or services for which the landowner would otherwise have to pay.

The ways wildlife can benefit landowners are outlined below. The list is not necessarily exhaustive but includes the majority. The outline is in ascending order of returns and input. Here returns will basically be in monetary terms although, as indicated, benefits are not confined to money alone. Input would be the monies and efforts expended for wildlife enhancement. Returns and inputs are tied together: with wildlife, as with most other enterprises, rewards are directly related to the effort expended.

### *1. Granting hunting or entry rights without fee or other direct compensation.*

In some areas, community customs and traditions may dictate this as the only course open to a landowner. The landowner may also follow this course where wildlife is an incidental by-product, produced at little or no direct cost to the owner.

In almost every instance the landowner will be the recipient of community approbation and goodwill. Although these returns are not money, they are valuable. They ease

social relationships and may lead entrants to a better understanding and appreciation of the landowner's role in producing and providing wildlife.

### *2. Exchange of hunting or entry rights for protection from further ingress.*

Where trespass, innocent or willful, is a problem, the landowner may arrange for a person or group to have hunting or other rights in return for "patrolling" the boundaries of the property. Such an arrangement might be desirable when unauthorized entry with vandalism or negligent damage is a problem. Very often the landowner will have made no direct outlays for wildlife; costs attributable to wildlife are minimal. The returns are not in the form of money per se but in a possible decrease in costs resulting from unauthorized entry and in an increased sense of security.

### *3. Exchange of hunting or entry rights for the performance of wildlife-enhancing practices.*

Most landowners have some interest in wildlife; however, few can afford to undertake active management with no hope of return. Very often the landowner can locate a group willing to carry out practices in return for the right to utilize the resource produced. Returns to the landowners would be improvements to the land, and those benefits given under the first two headings above.

### *4. Long- and short-term leasing of hunting and entry rights.*

If the landowner has sufficient wildlife and so desires, it is possible for him to realize a direct monetary return. The return per unit area is generally—but not always—directly related to the numbers of wildlife and to the input to wildlife. Under some circumstances, wildlife numbers are the incidental result not of practices directed to their enhancement but rather the result of practices directed to utilization of other products of the land.

The nature of the lessee will be variable: individual, loosely organized group, club, corporation, etc. The most desirable lessees will depend in large measure on the needs and desires of the lessor. The same is true of the duration of the lease although this may also depend upon other factors such as tradition, species available (see Chapter 24).

### *5. Daily fee areas for non-consumptive utilization of wildlife.*

Rare indeed is the person who does not thrill to the presence of wildlife, especially if it is of an uncommon

nature. Many are quite willing to pay for such an experience. Returns to the landowner may be quite high but so are the necessary inputs and risks. If the landowner is to obtain and maintain a clientele, he/she must be able to provide the desired experience. He/she must be willing to make expenditures of capital and labor with the understanding that it may be some time before a payoff occurs, and he/she must also be prepared for the possibility of losing all he/she has put into the venture. However, once the venture begins to provide a return, such land use may be economically competitive with any other land use. But again, it must be remembered: returns will be directly related to input. Of course, a part of the effort and return may be only indirectly related to wildlife, e.g., concession stands.

#### 6. *Hunting Preserves.*

As the number of people wishing to hunt increase and the land base providing hunting shrinks, the number of people willing to pay for the privilege of hunting will increase. For some time a large proportion of these people will be accommodated by the means outlined above, but, even now, more and more people are turning to those who can provide hunting in much the same way as other forms of recreation—as a commercial venture (see Chapter 24).

Wildlife can provide an economic return to the landowner, and the return will usually be in proportion to the input directed to wildlife. As with any venture, trying to obtain such returns is not without risk. Before anyone attempts to make money from wildlife, especially with intensive management, it would repay his/her efforts to seek advice. Good sources of help include professional consultants, other operators, an attorney, an insurance agent, the county extension agent, game and fish biologists and others listed in the sections on people management and assistance.

### ***Tips on Granting Permission to Hunt***

What would you do if someone, perhaps a stranger, asks to hunt on your land? Your answer, whether favorable or not, will likely depend for the most part on past experiences with hunters rather than your impression of the present askee. Before you make your decision there are some things you should consider. First of all, who is this stranger? Secondly, what are some of the pros and cons of granting permission?

#### ***Who is this Stranger?***

Ironically, most hunters who ask permission to hunt on your land may not be strangers at all. Nine times out of 10 they may be local people and in many cases, farmers or landowners like yourself. Some of the strangers may be farmers or ranchers from other parts of the state who may not have the wetlands to support waterfowl or the rangelands to support upland game. Or, they may be farm kids,

one generation off the farm with folks still farming.

In many of these cases, there wasn't enough land to go around so they had to move to the city. In any event, it is entirely possible that many of them have connections in one way or another to the land, and most of these may still be farmers, ranchers, and landowners at heart.

### ***Pros and Cons of Granting Permission?***

Why should you allow someone to hunt on your property?

1. Granting permission may help to maintain good community relations. Refusing to allow an acquaintance or member of the local community to hunt can lead to a disruption of community harmony and bad feelings.
2. Allowing a stranger to hunt may lead to new friends and could result in opening up new opportunities for you. For example, you might be "trading" quail or pheasant hunting for goose hunting or vice versa.
3. If you are suffering animal or bird damage to rangelands or crops, hunting can help alleviate this situation (It is not the whole answer, but it helps).
4. Some may feel a sense of attachment to the tradition of unrestrained hunting. This feeling is becoming rarer, but it does still exist.

Now for a look at the other side of the coin. What are some of the reasons for not granting permission to hunt on your property?

1. Property damage may take place—gates may be left open and stock may stray; fences may be broken down; nails may be put in trees where tree stands are built; crops and hay fields may be trampled; there may be littering; and outright vandalism may occur.
2. Some to whom you give special permission may take advantage of your hospitality by bringing friends and relatives to hunt on your property. They may come to accept your permission as a "God-given right" and not the revocable privilege it is.
3. Having others on your property does lead to some loss of privacy and a certain amount of restriction on where and when and what you do.
4. Finally, you may wish to have the game produced on your property for your own hunting or viewing pleasure.

### ***Extra Income from Fee Hunting and/or Fishing***

In times of economic uncertainty, it makes good sense for ranchers and farmers to consider alternative sources of income from their land. One such income source is fee hunting, or the leasing of hunting rights on private property. Managing your farm or ranch for income from hunters deserves consideration if you want to supplement your family's income.

## *What is Fee Hunting?*

Fee hunting (also called lease hunting) occurs whenever a landowner allows a hunter access to his property for a specified time period, for the purpose of hunting, in exchange for money, goods, or services. The agreement should always be formalized with a written lease.

The simplest type of fee hunting arrangement is a basic access fee agreement with few or no services provided to the hunter. Although a fee hunting enterprise can be elaborate—including, for instance, cabins, meals and guides—the basic access fee may be the place to start for most farmers and landowners. It can provide a supplementary source of farm income without large investments of time or money. Wildlife belongs to the state and cannot legally be sold. That is why landowners sell access only and must abide by all state game regulations.

## *Hunter Services*

Some landowners may want to increase their profits by offering extra services to hunters. There are all kinds of possibilities, some of which are listed below. Keep in mind that all of them require more work and some considerable investment of money.

- Blinds, decoys, other equipment
- Campsites, cabins, trailer hookups, restrooms
- Cleaning and refrigeration of game
- Dog training, boarding, field trials
- Hunting guides
- Meals and lodging
- Specialized organized shoots (usually dove)
- Target shooting, trapshooting, sporting clays

Landowners who want to provide additional hunter services for extra income will find suggestions in the Farm/Ranch Recreation Inventory Checklist (Appendix A, Chapter 24).

## *The Growing Market for Fee Hunting*

Hunting is tremendously popular in the U.S. Hunters make up 10 percent of the adult population.

An estimated \$3.8 million was paid to private landowners in 1985 for hunting privileges on Delaware lands. More than 90 percent was spent for waterfowl hunting privileges, with waterfowl hunters spending an average of \$325 per hunter for these privileges.

Rising land values, increased demand for hunting sites, plus a wide disparity between production costs and benefits of wildlife to the landowner, are resulting in a decrease of wildlife abundance and private lands for public hunting. Support by conservation agencies for a “fair market value” trespass fee to hunt on a private owner’s land might alleviate the situation.

Since about two-thirds of all hunters do not own hunting land, most pursue their sport either on public land or

private land owned by someone else. Two fairly recent developments have led to a shortage of good hunting land in some areas of the country.

First has been the tremendous increase in recreational use of public land. In 1962, the Outdoor Recreational Resource Review Commission predicted that outdoor recreation demand would triple by the year 2000. In fact, it had tripled by 1983. Much of the nation’s public land is at present overcrowded and under-maintained, with little relief in sight.

Second has been the closing of much private land to hunting. Two-thirds of the land in the United States is privately owned, and for most of the nation’s history, hunters have relied on the goodwill of private landowners to provide their hunting spots. But with increasing trespass, vandalism, and liability problems, (Appendix A), many property owners have had a change of heart. Numerous studies have indicated that 25 to 50 percent of private rural lands in the U.S. have some type of hunting access restriction, and a national survey conducted by Future Farmers of America in 1981 indicated that at least 46 percent of private land is posted. Up to 80 percent of the private lands of some populous northern states is closed to recreational access.

Probably the most telling evidence of a shortage of hunting land was a 1986 nationwide poll done by the National Shooting Sports Foundation. It showed that hunters rank “access to hunting land” the number one problem in the sport today.

Although the dearth of hunting land is a problem for hunters, it could be an opportunity for landowners. Fee hunting is on the rise in many areas of the country and, in fact, has increased dramatically over the past 10 years in the southeast and mid-Atlantic states. If trends continue, hunting land will become an increasingly valuable commodity, especially near urban areas or in locations where public land is scarce.

Fee hunting tends to be most common in states with smaller proportions of public land. In 1980, most leases were located in the South or Plains states, where the percentage of public land is low—about 5 percent in each state. The fewest leases were in the West, where about half of the region is public land. Private land has been leased for hunting in Texas since the 1930s, and fee hunting there has become a successful tradition. Texas landowners hold about 14,000 leasing licenses and take in between \$150 and \$200 million a year in hunting fees.

Fee hunting is also popular in New Mexico, Louisiana, Mississippi, Florida, South Carolina, Maryland, and New York, all of which have 40 percent or more of their private land leased for hunting. In the southern states particularly, leasing of forest industry lands has been a common practice for many years and contributes significantly to the high percentage of leased private land.

## *The Pros and Cons of Fee Hunting*

Like any other business enterprise, fee hunting has its advantages and drawbacks. The advantages of a fee hunting arrangement fall into three categories: 1) income, 2) protection/improvement of property, and 3) satisfaction of providing a valued service.

*Income.* While basic access fees may not provide the major source of farm or ranch income, they can still be worth the effort. For example, annual fees for deer hunting vary greatly across the nation but are generally in the \$2 to \$10 per acre range. A 2000-acre tract could thus bring in between \$4000 and \$20,000 per year from deer hunting alone. On a per-acre basis, access fees for waterfowl hunting and fishing provide far greater income than for most upland game hunting.

*Protection/improvement of property.* The hunting lease arrangement may help a landowner gain control over property that is frequently trespassed or vandalized. Hunters who have paid for hunting rights have a proprietary interest in the land and are usually willing to watch for uninvited hunters, rustlers, and other intruders. The landowner both protects his property and has the security of knowing exactly who is on the land during various hunting seasons.

As part of the lease agreement, the landowner can also arrange for the hunter to perform certain duties that will improve the property. These may include maintaining fences, buildings, or equipment; helping with various construction projects; or carrying out conservation practices.

*Personal satisfaction.* Fee hunting is an option for landowners who do not want strangers on their property but who also do not want to close their land to hunting. With lease arrangements, a landowner can get to know the hunters and have the satisfaction of providing a valued public service without a loss of security.

The drawbacks of fee hunting can also be grouped into three categories: 1) costs, 2) liability, and 3) people problems.

*Costs.* As explained in Chapter 23, "Private Property: Rights and Liabilities," the landowner has a greater legal responsibility for anyone from whom fees are collected for entry onto his/her property. Liability insurance will increase, depending on the type(s) of recreational activity provided. Also, property taxes can increase in some states when land is switched from agricultural to recreational use(s). Check with your county assessor.

Even a basic access arrangement may not be cost-free, especially in the beginning. Possible expenses include a lawyer's fee to draw up the lease, posting and fence repair, road repair, clean up or barricading of hazardous areas, and advertising. While adding hunter services may increase income, it will also increase expenses.

*Liability.* Liability has been a major deterrent to landowners starting fee hunting operations. All too often,

they find it difficult to locate an insurance agent or broker who will provide them with adequate coverage for their enterprise at a reasonable annual fee.

*People problems.* Anyone who leases hunting land will have to deal with people, and occasionally with people problems. In addition to meeting with hunters to arrange leases and collect fees, a landowner may have to contend with hunters on the land at odd hours, frequent calling to ask about prices, and occasional personality conflicts with hunters. (This isn't common because hunters who have paid a fee try to keep a good relationship with the landowner.)

## *Managing Your Lands for Fee Hunting*

To develop a successful wetlands or uplands hunting enterprise, study the factors discussed below. But, bear in mind that it often takes a few years to develop your skills in providing the high-quality recreational experience that hunters want to return to and will pay well for. Don't be in a hurry. Start out with only a few hunters and increase the number as you develop your skills. With care and patience, you should be able to gradually increase the income from your hunting enterprise.

## *What Could Your Wetland Offer to Hunters?*

Some pieces of property are obviously not suited for fee hunting. If your tract is inaccessible, has few waterfowl and is full of safety hazards, you may not be successful charging for access. But assume you own a tract that is fairly hazard-free, close to a road, and on which you often see lots of waterfowl. Although there is no accepted minimum size, common sense dictates that larger tracts of high-quality habitat may be more marketable. In anticipation of leasing this property for fee hunting, you should know:

- The wildlife production potential of your land. This includes the game species present, and how well the land is likely to support them in the future. Although you may have a fairly good idea (especially if you have hunted the land yourself), enlisting the help of a wildlife management specialist or consultant can be extremely helpful. (see Appendix A, Chapter 24).

- The accessibility of the property. Roads or trails into a large acreage mean more opportunities for hunters, while difficult access may make the property less appealing and more difficult to service or police. Another consideration is the distance of the property from population centers.

- How much public or open private land is nearby. Leasing land may be more difficult in areas with lots of free hunting. However, where public-use areas are crowded, hunters may be willing to pay.

- The exact location and condition of all hazards, including abandoned buildings and vehicles, vicious animals, quicksand, and trash piles.

This information will let you see just how much you have to offer a hunter. It will also help you decide what kind of leasing arrangement you want, and how much you can reasonably charge.

Hunters spend for guns, ammunition, equipment, clothing, licenses, lease payments or daily fees, travel and other expenses, many times more money than the value of the meat taken home. Why?

Hunters want a *recreational experience* as much as or even more than taking home any ducks, geese, deer or other game they have killed. They enjoy the scenery, a few days or a week of being out-of-doors, getting away from the urban grind, and feeling welcome on the farm or ranch. They enjoy seeing other wildlife and hunting in familiar places that bring back memories of past hunts. The privacy and safety of having few other hunters around is especially important.

Therefore, your concern should be not only the likelihood of hunters filling their bag limits on your farm or ranch; but more importantly, their prospects for a high-quality recreational experience. Don't underestimate the variety of features that your farm or ranch could offer to hunters in providing this experience. The total *recreational experience* of the hunt is what hunters want and what you must provide.

Providing a satisfying recreational experience means pleasing people, including people who are hard to please or even to get along with. Skills in human relations are essential, and not all of us have them or can easily learn them. Unless you genuinely like people and are anxious to please, you may do well to stay out of the recreation business.

Misunderstandings and disagreements can easily arise. The best safeguard is a written contract that both you and your customers must sign. This contract should make clear your responsibilities and those of the customer and include any pertinent restrictions or requirements. (see Chapter 24, Assessing the Farm/Ranch Recreational Potential.)

You may want to require that your customers have completed a hunter education course and follow The 10 Commandments of Gun Safety (Table 1). You should

clearly mark areas on your farm or ranch where hunting is and is not permitted. You should also be sure that hunters know where your property ends and your neighbors' begins, and you should inform your neighbors that hunters are on your property. It may even become a good idea to take your neighbors into your hunting business to expand your hunting area.

### ***Enhancing the Hunting Experience and Minimizing the Potential Conflicts***

Suppose that after considering the pros and cons you decide to allow others to hunt on your property, what can you do to enhance the experience of both hunters and landowners while minimizing the potential conflicts. Because of the complexity of finding just the right program, suggestions to this question have been included in chapter 23, Private Property: Rights and Liabilities.

**Table 1. The Ten Commandments of gun safety.**

1. Treat every gun with the respect due a loaded gun.
2. Watch the muzzle. Carry your gun safely. Keep safety on until ready to shoot.
3. Unload guns when not in use; take down or have actions open; guns should be carried in cases to shooting area.
4. Be sure barrel is clear of obstruction, and that you have ammunition only of the proper size for the gun you carry.
5. Be sure of target before you pull trigger; know identifying features of the game you hunt.
6. Never point a gun at anything you do not want to shoot; avoid all horseplay.
7. Never climb a tree or fence or jump a ditch with a loaded gun; never pull a gun toward you by the muzzle.
8. Never shoot a bullet at a flat, hard surface or water; at target practice be sure your backstop is adequate.
9. Store guns and ammunition separately, beyond the reach of children.
10. Avoid alcoholic beverages before or during shooting.









## Appendix A. Synopsis of Trespass Laws

*Unlawful hunting.* (K.S.A. 21-3728) Unlawful hunting is fishing, or shooting, hunting or pursuing any bird or animal upon any land of another or from any traveled public road or railroad right-of-way that adjoins occupied or improved premises, without having first obtained permission of the owner or person in possession of such premises.

*Unlawful hunting is a class C misdemeanor* punishable by up to \$500 fine and 30 days in jail.

*Criminal trespass.* (K.S.A. 21-3721) Criminal trespass is entering or remaining upon or in any land, structure, vehicle, aircraft or watercraft by one who knows he is not authorized or privileged to do so, and, (a) he enters or remains there in defiance of an order not to enter or to leave such premises or property personally communicated to him by the owner thereof or other authorized person; or (b) such premises or property are posted in a manner reasonably likely to come to the attention of intruders, or are fenced or otherwise enclosed.

*Criminal trespass is a class B misdemeanor* punishable by up to \$1,000 fine and 6 months in jail.

*Unlawful trespass.* CHAPTER 132: An act concerning fish and game; relating to penalties for violation of fish and game laws; amending K.S.A. 32-130a, 32-142a, 32-154c, 32-165, 32-215 and 32-509 and K.S.A. 1984 Supp 32-110b and repealing the existing sections.

Sec. 3 K.S.A. 32-142a is hereby amended to read as follows: 32-142a. Any landowner or person in lawful

possession of any land may post such land with signs stating that hunting, trapping or fishing on such land shall be by written permission only. Any person who shoots, hunts, traps or pursues any bird or animal or who fishes upon land which is so posted, without having in possession the written permission of the owner or person in lawful possession thereof, shall be guilty of a class C misdemeanor.

In addition to any authorized sentence imposed by the court, the hunting or fishing license of the convicted person shall be subject to suspension or revocation as provided by section 8. A person licensed to hunt and following or pursuing a wounded game bird or animal on posted land without written permission of the landowner or person in lawful possession thereof shall not be deemed to be in violation of this provision while in such

Note: This is the law which enables law enforcement officers to help you control hunting on your property. It only covers hunting, fishing or trapping, therefore, officers can only handle hunting, fishing or trapping problems under this law.

In addition to the above penalties, the court may require forfeiture of hunting privileges for the individual.

If you have any questions on trespass or illegal hunting laws, please contact your Sheriff's office, Conservation Officer, or Parks and Wildlife Department office for advice or clarification.



## Chapter 23

# Private Property Rights and Liabilities

Jeff Powell and Richard Olsen  
with modification by Edward Kozicky

## ***Landowner Liability***

Fear of liability exposure is a major deterrent to the development of farm/ranch recreation, although the real probability of lawsuits is unknown. To date no known landowner liability suits involving fee hunting have come to trial in the U.S., and no state wildlife agency reports they are a problem.

Landowners still worry about liability exposure even though 46 states have recreation use statutes protecting private landowners from liability suits from recreation users given free access, except in cases of gross negligence. While legal experts have stated they believe such statutes provide substantial protection to owners, the laws have seldom been tested. Landowners should always take the threat of lawsuit (and the safety of their hunting clients) seriously.

Liability risk also varies widely among states. Some states have legislation limiting the liability for recreation-related accidents depending on the gross revenue received by the operator. Incorporation may reduce the risk, but this depends largely on the degree to which a rancher is an active participant in the management of the operation. The liability issue is certainly one on which each rancher should consult his attorney and insurance agent.

As a general rule, as the legal status classification of people on private land increases, landowners owe them more legal protection. Landowner liability exposure also increases.

The legal status of various people on private land might include (in order of legal rights) habitual trespasser, discovered trespasser, trespassing children, permittee (sometimes called licensee), and invitee. In other words, a landowner is much more liable to a person who pays (invitee) to hunt on private property than one who hunts for free but with permission (permittee or licensee) or the habitual trespasser.

Contrary to what some landowners may think, even trespassers have rights these days, so don't even think about shooting them or setting traps. Farm/ranch operations providing access, room, board, and rentals will also be subject to liability concerning licensee, invitee, bailment, innkeeper, and regulated service and sales.

## ***Legal Definitions of Landowners and Users***

### **Fee Simple Estate**

The largest "bundle of rights" that an individual can possess in real estate property is called the fee simple estate. This bundle permits the owner to legally possess, use, enjoy,

control, dispose of, protect, and defend his/her property. A fee simple owner's only limitations of use may come from governmental and private bodies in the form of injunctions or directives to acquire property for, or to prevent uses that interfere with the health, welfare, and interest of the public.

## **Cotenancy**

Cotenancy arrangements are similar to the fee simple estate. In cotenancy arrangements, ownership is divided among two or more persons. Cotenants have simultaneous interests or undivided ownership in every portion of the property. There are three basic cotenancy arrangements: tenancy by the entirety, joint tenancy, and tenancy in common.

*Tenancy by the entirety* can only be created between husband and wife with the right of survivorship as a distinguishing characteristic. Upon the death of one cotenant, his/her interest automatically passes to the surviving cotenant. In legal terms, this is called the right of survivorship.

*Joint tenancy* can be created between two or more persons, providing it is created at the same time, by the same instrument, with the same estate granted to all, and with each receiving an undivided interest in the whole. As in the tenancy by the entirety, the right of survivorship attaches transferring to the remaining cotenants the deceased's interest in the property.

*Tenancy in common* is created between two or more persons whose only related interest is joint possession of the property. Upon death of one tenant in common, his/her share or interest passes to his/her heirs rather than to the remaining cotenants.

## **Status of Property Users**

The status of a user of private property determines the degree of care and liability owed by the landowner. Therefore, it is important to be able to determine the legal relationship of an injured person to the landowner. There are four distinct user categories: invitees, licensees or permittees, trespassers, and children covered under the "attractive nuisance" doctrine.

An *invitee* is a person invited or permitted to enter or remain on another's property for some purpose connected with the owner's business or for a mutual interest. Some courts require that the business upon which he comes be pecuniary in its nature (of some economic benefit to the landowner/manager/operator); others require only that it be such that there is an implied representation care has been exercised to

make the land safe for the visitor. Most clients of fee hunting enterprises would probably be classified as invitees.

A *licensee* is a person *privileged* to enter upon another's property, with the owner's consent, for the *licensee's* own interest or benefit. He is simply given a license to enter and perform those acts permitted by the owner. The license may be verbal or written permission. It is nontransferable by the user to another person and ordinarily is revocable by the landowner at any time.

The lowest form of user is the *trespasser*. He is a person who enters and remains upon the property of another without permission to do so. He may also be a person who has exceeded the privilege granted by a license or invitation.

The legal concept known as the "attractive nuisance" doctrine grew from the law surrounding trespassing children. This doctrine permits an exception where the trespasser is a child. Child trespassers were granted this exception because of their immaturity and lack of understanding and appreciation for potentially dangerous situations. The result of this rule is to permit recovery of damages or loss to children occupying this status.

### **Rights of the Landowner**

One of the most important rights a landowner has regarding the public and his property is the right to exclude others from entering and remaining on his premises. Private property should be posted, however, to inform the public of its boundaries and the owner's desire to permit or prohibit certain activities. Limitation was placed on property opened to the public for business purposes by the Civil Rights Act of 1964. Under this Act, exclusion cannot be based on creed, color, or race.

Public lands leased for use to private individuals do not ordinarily convey the exclusion privilege. For example, a farmer or rancher who has use of public lands for livestock grazing cannot exclude fishermen, hunters, or others from entering the range who desire to perform lawful acts. This limitation, however, does not permit such users access across private land to reach the public domain, nor does this allow other users to interfere with legal activities of the lessee. For example, a fisherman cannot demand that a stockman move his livestock away from the stream because they are interfering with his fishing, nor can the fisherman, his dog, or his children harass the livestock.

### **Liabilities of the Landowner**

The general rule of landowner liability is: the rights which the law permits a landowner to exercise over his property are not so broad as to allow him to negligently injure others or their interests through the use of his property. For example, a landowner will not be permitted to construct a dam on his property in such a manner that it poses a constant threat to his neighbor's property.

Due regard must be taken for the public good, and humane interest for the welfare and rights of others must be exercised. As previously stated, the status of a user determines the degree of care and responsibility owed.

A landowner's liability to an invitee exists only for hazards which he knows of or should have discovered. The hazard may be natural or man-made, such as quicksand ponds or a highly charged electric fence.

The property owner has a greater legal responsibility to the invitee than to the licensee. The landowner is required to exercise reasonable care to warn the invitee, or to make the premises safe for him, as to dangerous conditions or activities of which the landowner knows or those which he could discover with reasonable care. The obligations exist only while the visitor is upon the part of the premises on which his invitation extends.

Ordinarily, a landowner owes a licensee nothing more than a duty of not willfully and intentionally injuring him. The licensee is on the premises for his own interest, and he need not be informed of apparent dangerous conditions. The landowner is under no obligation to exercise care to make the premises safe for the licensee and is under no duty toward him, except to use reasonable care to a) discover him and avoid injury to him in carrying on activities upon the land, and b) warn him of any concealed dangerous conditions or activities which are known to the landowner or of any changes in the condition of the premises which may be dangerous to the licensee, and which the licensee may reasonably be expected not to discover.

The duty owed a trespasser is not to injure him by any direct act after learning of his presence on the property. Owners should use reasonable care not to create conditions (i.e., traps) which may injure known trespassers; however, they are under no obligations to keep or make their premises safe for trespassers.

In general, a landowner is not liable for harm to trespassers caused by his failure to put the land in a reasonable safe condition for their reception (use), or to carry on his activities so as not to endanger them. An increasing regard for human safety, however, has led to the development of the exceptions to this general rule that a) if the presence of the trespasser is discovered, the landowner is commonly required to exercise reasonable care for the trespasser's safety as to any actual operations the landowner may carry on and possibly as to any highly dangerous condition of the land; and b) if the landowner knows that trespassers frequently intrude upon a particular place or a limited area, he is required to exercise reasonable care as to any activities carried on and probably as to any highly dangerous conditions.

The fourth group of individuals which are potential risks are children sheltered by the "attractive nuisance" doctrine. This doctrine was designed to provide protection for children to tender ages injured by some enticing instru-

ment or condition on the owner's property. Most state courts have favored the landowner who has taken steps to prevent children from reaching a "nuisance condition" by adequately fencing it off. Before legal recovery by children will be permitted, 5 elements surrounding the injury must exist:

1. The landowner knows or should know that the instrument or condition (e.g., fishing pond) would attract children.
2. It must be a condition involving an unreasonable risk of harm (e.g., drowning) to children.
3. The injured child must not discover the condition or appreciate the danger (i.e., be forewarned) prior to his injury.
4. The cost of removing the condition must be small compared with the risk to children.
5. In some states, the child's injury must be caused directly by the instrument or condition inducing or inviting his trespass.

### **Liabilities of the Recreation User**

Any recreationist who negligently injures another person is liable for damage inflicted. If the injury was willfully and intentionally caused, liability may not only be civil, in the form of a personal injury award to the plaintiff but also criminal, such as assault and battery.

Liability to the landowner also exists for injury or destruction of property. Many states make some of these offenses both civil and criminal wrongs. For example, a person who cuts, breaks, or destroys a fence or who maliciously injures or kills livestock may be statutorily liable to the landowner for as much as four times the damage done and is guilty of criminal activity. In some states habitual trespassers have fewer rights than accidental or first-time trespassers.

Liability to the state of federal government exists for certain conduct. For example, by statute, anyone who fails to extinguish a campfire before breaking camp may be punished by a fine and/or jail.

### ***Risk Management: Techniques for Limiting Liability***

Recognizing that certain liability exists when using private property for outdoor recreation, the owner should take positive action in organizing and operating his facilities to avoid or limit potential losses. This is called "Risk Management". Risk management is the least expensive means of limiting liability exposure and maintaining public good will.

### **The Risk Management Process**

The risk management process includes 4 steps:

1. Risk *identification* (torts, contracts, fidelity, property loss);
2. Risk *evaluation* (probability and severity);
3. Risk *selection* (avoidance, reduction, retention and/or transference);

### **4. Risk *implementation policy and procedures manual.***

There are many possible tactics of limiting liability, but there are basically only two strategies to follow: 1) maximize safety and minimize injury, and 2) protect yourself in case someone is injured on your property. The first strategy involves primarily the landowner and his employees, and concerns removal of dangerous conditions, exclusion of unwanted persons, and avoidance of willful negligence on the part of the rancher and his employees. The second strategy usually requires legal (e.g., written lease, incorporation) or financial (e.g., insurance) assistance of an outside entity.

For the most effective risk management by farm or ranch recreation operators:

1. All dangerous conditions should be identified and eliminated where possible.
2. Accessibility to dangerous conditions which can not be eliminated should be minimized.
3. Employees should be trained to work with people and be alert to potential dangerous situations.
4. Managers should develop a written safety/inventory checklist, inform the recreationists of the dangers, and have the recreationists acknowledge in writing they were informed of the risks (e.g., liability waiver).
5. Skilled and alert management should always be provided.
6. Unwanted recreation users who appear to be a potential risk because of their condition (drunk, belligerent, etc.) should be excluded from the premises.
7. Post property boundaries and diligently prosecute violators. While the state owns all resident wild birds, fish, and wild animals, a farmer or rancher may control hunting on private land which he owns or rents.
8. Interview every applicant yourself. This is too important to leave to others.
9. Grant written permission which states among other things, the specific time and the specific places for which it is granted. In addition, the permit should also have a statement (liability waiver, indemnity clause, and hold-harmless clause) which says that the permittee absolves the permittor from liability for injury to self or property. (Although laws of many states also do this, such a statement may help reduce the possibility of suit.)
10. Make it very clear that permission is being given only for the person named on the written permit. Require that hunters check in and out.
11. Have set of carefully thought-out rules, go over them with hunters, and enforce them. Withdraw privileges from violators. Each landowner who grants permission will need his own set of rules which are applicable to his situation.
12. Enforce all state and federal game regulations.
13. Require completion of a hunter education course and/or enforce The 10 Commandments of Gun Safety.(Table 1, Chapter 22).

14. Don't allow drinking or drinkers to hunt.

15. Clearly state how you wish gate and fences handled.

For example, that gates should be left open if found open, shut if found shut; that fences should not be climbed or used for target practice or climbing.

16. Plainly mark and show the safety zones around houses and buildings.

17. Indicate on a map, areas open for hunting, roads which may be used, etc.

18. List the species which may be shot and those which you want left alone.

19. Make it clear that unsportsman-like behavior, whatever form it may take, will not be tolerated.

20. Don't let two groups hunt the same area at the same time.

21. Anticipate, mitigate, and communicate.

Some landowners mistakenly believe that posting "Not Responsible for Accidents" signs will relieve them of liability. This just isn't true. While they may discourage some people from suing, they don't provide any legal protection. Having the hunter's signature on a general release of liability is also of doubtful value. Hunters who pay a fee to enter property can not legally sign away their right to hold the landowner responsible for negligence.

A specific statement that may provide more protection for the landowner is an "agreement to participate" or "hold-harmless clause." Such a statement includes wording to the effect that the hunter understands the dangers, possible injuries, rules and regulations of the activity in which he or she is about to engage. In this type of signed release, the landowner is freed from the liability for the specific activity but not from negligence in general.

Agreements-to-participate are generally thought to have a better chance of holding up in court than a general release. However, nothing can keep you from being sued even though certain documents will help in your defense. Your best protection against liability claims is to keep both your property and your clients' behavior as safe as possible.

Kansas has a "recreational user" statute that relieves the landowner of any duty of care when the property is used for recreational purposes and no fee or other benefit is received by the landowner. The purpose of this law is to encourage landowners to open their property for public recreation. This law *did not apply* to fee hunting. As soon as some benefit is received, the landowner has much more liability.

However, an exception was made in 1988 with Senate Bill 529, which amended K.S.A. 58-3202, 58-3204, and 58-3206 and repealed existing sections. The purpose of Senate Bill 529 is to exempt landowners of agricultural land from liability even though they charge a fee for the recreational use of their land. For example, lands in the Conservation Reserve Program can be used for recreational purposes and fees can be charged. But, the threat of a liability suit has kept many landowners from doing so. This

law has yet to be tested in the courts, but should be a major deterrent to any liability lawsuits by recreationists on agricultural lands. Currently, the only exemption from landowner liability for nonagricultural land is land leased to the state or a subdivision thereof.

A landowner can protect himself from liability loss by obtaining assistance from one or more of several different sources. Certainly an attorney has to be near the head of the list along with an insurance agent. Other "agents" who can help minimize liability loss include the sheriff, the local judge and county attorney, conservation officers, neighbors, outfitters, and sportsmen's associations.

### ***Incorporation***

A corporation may be created with little difficulty and for any lawful purpose. Its main feature of interest to recreation-minded landowners is the limited liability it affords. Liability in most cases is limited to the amount invested in the corporation. Consequently, only that property placed in the corporation would be subject to a damage or injury claim. A landowner can thereby exclude lands and other property from the corporation which he feels would not be needed for recreational activities. Contact your attorney about participation in a limited liability corporation.

### ***Liability Insurance***

The surest form of protection from loss is liability insurance. This insurance shifts much of the risk of loss from the landowner to the insurance company. It promises to pay "in behalf" of the insured those amounts for which the insured may become legally liable, subject to the policy limits.

In many states liability insurance concerning farm/ranch recreation is either non-existent or very inconsistent in regard to coverage and premiums. Insurance companies do not yet have the actuary data to develop farm/ranch recreation industry norms.

Consequently, many insurance companies are uncertain how to calculate premiums and there is no consistency among insurance companies in regard to farm/ranch recreation policies. Group insurance may be obtainable in some states, but not in others. Some companies will simply attach a rider to the existing farm/ranch policy at minimal additional premium. The additional premium cost varies widely with the services offered. Anything that moves under power (e.g., horses, machines) is generally considered dangerous and increases the premium cost.

Liability insurance policies are of various types. Of particular interest to property owners engaging in recreation are the following policy types: 1) Owners, Landlords, and Tenants; 2) Comprehensive Liability; 3) Farmers Comprehensive Personal Liability; and 4) Recreational Activity Insurance. These various types of policies should be discussed with an insurance agent to determine the extent of

coverage offered and to select the policy which will provide adequate protection for the landowner's particular situation.

In general, insurance coverage can be obtained for personal acts caused by the insured, members of his household, employees, acts of his animals, property damage, off-premises damage and injury, public medical payments, and product liability for farm products sold to others. Each policy should be read with care, particularly the "exclusions" section. The agent should be informed of every type of recreational activity to be engaged in on the property; the kind, quality and age of equipment; extent of anticipated use of the equipment; personnel to be employed; location of the property with reference to medical and law enforcement facilities; and other pertinent information.

Rates for insurance will vary depending upon the type of policy selected, extent of coverage, conditions of the insured, size of the family and age of the children, and equipment and acreage of property insured. Coverage will vary depending on licensees, invitees, trespassers, animals, and equipment. Actual premium costs will vary with each individual case.

There are a number of carriers that provide coverage for the more popular outdoor activities and a number of carriers who will not provide any coverage for outdoor recreation. Because of the high degree of perceived risk involved, recreation coverage may be considerably higher than standard policy premiums. Another feature of recreation activity insurance is that some insurers will base their premiums for particular activities on a seasonal basis rather than charge an annual premium.

Group insurance for this industry may or may not be obtainable depending on state laws. Insurance companies may or may not provide coverage for an operation where all or part of the enterprise pertains to recreation, so risk management and shopping for the best coverage at the lowest cost are the two alternatives. Representatives from the insurance industry and state insurance commissioner's office should be consulted and should be asked to serve on a state coordinating committee for fair and consistent insurance policies.

Some of the risk and liability can be transferred to a broker or outfitter. Certain state laws pertain to guiding and outfitting operations (Appendix A). These statutes define outfitters, guides, and employees and set out specific requirements that must be adhered to. Therefore landowners and state legislatures and agencies need to review regulations regarding outfitter bonding and liability.

Some state and national sportsmen's groups encourage landowners to open their land to recreation by various landowner-sportsmen programs. Some of these sportsmen's groups will assume limited liability (up to a certain amount) for its members who cause damage to a participating landowner's property. Landowners may want to require leasing groups to take out liability insurance. The landowner

may then be named as an additional insured for a small percentage of the basic policy cost. Hunters or persons using your land should be capable of assuming liability for any damage caused by their activity or presence on your land.

Legislation concerning farm/ranch recreation liability should be reviewed by state legislators and tested by courts if landowners are to have any confidence in existing or new laws limiting liability. An example of proposed model legislation for private lands and public recreation was prepared by Professor W.L. Church of the University of Wisconsin Law School on access, liability, and trespass and is available. The report by Professor Church, entitled "Private Lands and Public Recreation" was completed in 1979 and placed in the Council of State Governments' annual list of suggested state legislation by a coalition of National Association of Conservation Districts, Wildlife Management Institute, National Rifle Association, National Wildlife Federation, and International Association of Fish and Game Commissioners. The attempt was considered only partly successful because large damage claims were still being awarded in landowner liability cases.

A similar model of limited liability, entitled "Wisconsin's Recreational Use Statute: Limiting the Injury Liability of Private Landowners" is available from the Wisconsin Cooperative Extension Service. The statute, Wis. Stats. 895.52, limits property owners' responsibility for people who use their land for recreation.

Wisconsin's recently revised recreational use statute protects private (as opposed to commercial) property owners by limiting their legal responsibility for persons who may be injured while using that owner's land for recreational purposes. A recreational activity is defined as nearly every outdoor pursuit except organized team sports.

In general, property owners are not liable for injury to a recreational user that is caused by the natural conditions of the land, by other recreational users, or by wild animals. Owners may be liable for injuries to recreational users of their land if they neglect to warn about a hazard known to them or if they have a malicious intent to injure the user. There are other situations in which landowners may be liable, such as when an injury occurs to an invited guest near the home or near a building used for selling or making something or when the owner receives a substantial payment for the recreational usage.

Wisconsin's recreational use statute serves to clarify the legal responsibility of property owners who allow others to use their land for outdoor exercise, relaxation, or pleasure. *People who use an owner's land without permission are TRESPASSING.* They are subject to arrest and conviction under another section of state law.





## Questions for Chapter 23

1. Discuss the difference in legal rights between an invitee and a habitual trespasser on private property.
2. What is the fundamental right of a landowner regarding his property and the general public?
3. What is risk management?
4. Discuss the value to the landowner of an “agreement to participate” or a “hold-harmless” clause signed by recreationists.
5. What is the surest form of protection for the landowner from loss?
6. List 10 landowner risk management options.

Name \_\_\_\_\_



## Appendix A

### Regulations Pertaining to Recreational Guides

Guides; permit application, examination, and restrictions. (a) Each application for a commercial guide permit or an associate guide permit shall be on forms provided by the department and the guide permit fee is as prescribed under K.A.R. 115-2-1 shall accompany each application. In addition to information required by L. 1990, Chapter 141, section 1, each applicant shall provide the following:

- (1) proof of completion of the following courses:
  - (A) current certification in red cross or comparable first aid and cardio-pulmonary resuscitation training;
  - (B) department approved boat safety training, if a boat is used as part of the guiding service; and
  - (C) department approved hunter education training, if hunting is a part of the guiding service; and
- (2) the commercial guide or associate guide permit number if the application is for a permit renewal or permit revision.
  - (b) To be listed in an annual directory of Kansas guides, an applicant for a commercial guide permit shall sign the approval section on the permit application.
  - (c) Each applicant for a guide permit shall take a department administered guide examination. The written examination shall cover basic knowledge of:
    - (1) hunting or fishing skills or both;
    - (2) hunting or fishing safety or both;
    - (3) first aid;
    - (4) laws and regulations; and
    - (5) boating safety, if a boat is used in the hunting or fishing guide service.
  - (d) Each guide permit shall be restricted to hunting or fishing guide services, the use of a boat in the guide service, or any combination thereof. This will be determined by the examination sections taken and passed by the applicant.
  - (e) Each renewal application for a guide permit shall be submitted to the department not later than December 1 of the current permit year.
  - (f) Each applicant for renewal of a guide permit shall pass an examination at least once every three years as a condition of permit renewal.
  - (g) All examinations shall be administered at a department office.
  - (h) A score of 75 percent shall be the minimum passing score for each section of the guide examination taken.
  - (i) Any applicant failing an examination or any section of an examination may reapply after 30 days.
  - (j) Any guide permit restricted to authorize only hunting or fishing guide services or each guide permit that does not authorize the use of a boat may be revised at any time. Any permittee desiring a revision of their current permit may submit an application on forms supplied by the department and by passing the proper written examination.
  - (k) A current red cross or comparable first aid and cardiopulmonary resuscitation certification shall be required as a prerequisite to the examination requirements of subsection (f) for each permittee. (Authorized by K.S.A. 1989 Supp. 32-807 and L. 1990, Chapter 141, section 1; implementing L. 1990, Chapter 141, section 1; effective Jan. 28, 1991.)

New Section 1. (a) As used in this section:

- (1) "Commercial guide services" means providing, offering to provide, arranging for or assisting with hunting or fishing activities for others on a commercial basis, including but no limited to providing any one or more of the following when used in conjunction with or for hunting or fishing activities: Pack or riding livestock, transportation other than by commercial carrier, equipment or facilities.
- (2) Terms defined in K.S.A. 1989 Supp. 32-701 and amendments thereto have the meanings provided by that section.
  - (b) On and after January 1, 1991, a valid commercial guide permit is required to provide commercial guide services in this state.
  - (c) The provisions of subsection (b) do not apply to a person who:
    - (1) Possesses a controlled shooting area license and commercial guide services performed by the person are confined to the licensed controlled shooting area;
    - (2) owns private land and commercial guide services performed by the person are confined to lands owned by

the individual;

(3)provides commercial guide services in cooperation with a department-approved activity; or

(4)does not receive monetary compensation for providing commercial guide services.

- (d) Any person who desires to provide commercial guide services shall apply to the secretary for a commercial guide permit. The application shall give the name and address of the applicant, the type of commercial guide services to be provided, the area of the state where guide services would occur, a listing of facilities proposed for use, a listing of equipment to be available to the commercial guide service customers, including pack or riding livestock, and such other information as required by the secretary. The fee prescribed pursuant to K.S.A. 1989 Supp. 32-988 and amendments thereto shall accompany the application.
- (e) The secretary may issue a commercial guide permit if the secretary determines that:
  - (1)The applicant possesses adequate knowledge of wildlife and parks laws of this state and rules and regulations of the secretary;
  - (2)the applicant possesses adequate knowledge of hunting or fishing skills; and
  - (3)the application is complete and accurate.

The secretary may require an applicant to successfully complete a written or oral examination before issuing a commercial guide permit.

- (f) A commercial guide permittee shall make such reports of permitted activities to the secretary as required by rule and regulation adopted by the secretary in accordance with K.S.A. 1989 Supp. 32-805 and amendments thereto.
- (g) A commercial guide permittee may employ one or more associate guides to conduct services authorized by the commercial guide permit while the associate guide is in the employment of the commercial guide permittee. On and after January 1, 1991, an associate guide permit is required for any individual so employed by a commercial guide permittee.
- (h) Any individual who desires to obtain an associate guide permit shall apply to the secretary. The application shall give the name and address of the applicant; the name, address and commercial guide permit number of the commercial guide by whom the applicant would be employed; the notarized signature of such commercial guide permittee; and such other information as required by the secretary. The fee prescribed pursuant to K.S.A. 1989 Supp. 32-988 and amendments thereto shall accompany the application.
- (i) The secretary may issue an associate guide permit if the secretary determines that:
  - (1)The applicant possesses adequate knowledge of wildlife and park laws of this state and rules and regulations of the secretary;
  - (2)the applicant possesses adequate knowledge of hunting or fishing skills; and
  - (3)the application is complete and accurate.

The secretary may require an applicant to successfully complete a written or oral examination prior to issuance of an associate guide permit.

- (j) Commercial guide permits and associate guide permits expire on December 31 of each year.
- (k) A commercial guide permittee or associate guide permittee may assist with the legal taking of wildlife while providing commercial guide services but shall not perform the actual taking or shooting of wildlife for the guided person.
- (l) Unless exempt pursuant to K.S.A. 1989 Supp. 32-919 and amendments thereto, a commercial guide permittee or associate guide permittee shall be required to possess a valid hunting license issued to such permittee in order to conduct hunting activities. Unless exempt pursuant to K.S.A. 1989 Supp. 32-911 and amendments thereto, a commercial guide permittee or associate guide permittee shall be required to possess a valid fishing license issued to such permittee in order to conduct fishing activities. A commercial guide permittee or associate guide permittee shall be required to possess any stamp as required by law to engage in the activity.
- (m) The secretary shall adopt, in accordance with K.S.A. 1989 Supp. 32-805 and amendments thereto, such rules and regulations as necessary to administer and govern commercial guide services, including such restrictions and conditions as required for wildlife resource protection and to protect the public interest and public safety.
- (n) In addition to any other penalty prescribed by law, failure to provide required reports or failure to comply with the wildlife and parks laws of this state or rules and regulations of the secretary shall be grounds for the secretary to refuse to issue, refuse to renew, suspend or revoke a commercial guide permit or an associate guide permit. Any such refusal, suspension or revocation shall be in accordance with the Kansas administrative procedure act.

- (o) The secretary may prepare a general publication listing commercial guide permittees and services offered by the permittee for the purpose of assisting the public in securing the services of a commercial guide. No commercial guide permittee shall be included in such publication without the written consent of the permittee.  
History: L. 1990, ch. 141, sec. 1; July 1.

115-21-2. Guides; reporting requirements. (a) Each commercial guide permittee shall submit an annual report on forms supplied by the department. Each report shall contain the following information:

- (1) the name, address and permit number of the permittee;
- (2) for each day, the name and license number of resident and nonresident individuals guided for hunting or fishing or both;
- (3) for each day, a listing of the department land and water areas used while providing guide services for hunting or fishing or both; and
- (4) other information as required by the secretary.
  - (a) when requested by the secretary. Such reports shall cover specific hunting or fishing activities and shall be due within deadlines established by the secretary.
  - (b) Each commercial guide permittee shall submit interim reports to the department that contain elements of subsection
  - (c) Failure to submit a requested interim report by the established deadline shall result in permit suspension until the interim report has been received by the department.
  - (d) Each report submitted by a commercial guide permittee shall include all guiding activity of all associate guides employed by the commercial guide permittee.
  - (e) Each annual report shall be complete through December 31 of the permit year and shall be due to the department not later than January 15 of the following year.
  - (f) A renewed commercial guide permit or a renewed associate guide permit shall be suspended at 5:00 p.m. on January 15 of the permit renewal year if the annual report for the previous permit year is not received by the department by January 15 of that permit year. (Authorized by K.S.A. 1989 Supp. 32-807 and L. 1990,

Chapter 141, section 1; implementing L. 1990, Chapter 141, section 1; effective Jan. 28, 1991.)

- (4) other information as required by the secretary.
  - (g) This regulation shall be effective January 1, 1994. (Authorized by K.S.A. 1992 Supp. 32-807 as amended by L. 1993, Chapter 185, section 2 and K.S.A. 1992 Supp. 32-964 as amended by L. 1993, Chapter 278, section 1; Implementing K.S.A. 1992 Supp. 32-964 as amended by L. 1993, Chapter 278, section 1; effective Jan. 1, 1994.)

115-21-3 Provisional guides; registration and reporting. (a) Each individual desiring to conduct guide services as a provisional guide shall register with the department by providing their name and address to the department.

- (b) The required registration information may be submitted by the individual or for the individual by another person.
- (c) Each provisional guide shall possess a valid provisional guide card issued by the department to the provisional guide while the provisional guide is conducting guide services.
- (d) The registration and provisional guide card shall be valid from date of issuance through December 31 of the year for which the provisional guide card is issued.
- (e) If required by the secretary, a provisional guide card shall submit a report to the department within 10 days after guiding activities for the calendar year are completed or December 31, whichever event occurs first.
- (f) The report shall be submitted on forms provided by the department and shall contain:
  - (1) The provisional guide's name and address;
  - (2) the number of days guided and the number of clients guided per day;
  - (3) the amount of income received for each day of guiding activity; and



## Chapter 24

# Assessing the Farm/Ranch Recreation Potential

*Jeff Powell and Richard Olsen  
with modification by Edward Kozicky*

One of the basic economic problems with crop and livestock production is the low return on fixed assets. How can a farmer or rancher intensify the operation to generate more income without greatly increasing costs? Either he can increase prices for existing products or diversify and increase the kinds of products produced from the existing resources. However, farmers and ranchers already have the resources to provide the lure and romance of a working farm or ranch in the minds of urbanites two or more generations removed from the farm or ranch.

But, how can farmers and ranchers capitalize on this potential without going deeper in debt to serve the guests? The trick is to recognize, assess, and package what you already have in such a way that the market wants it and is willing to pay the necessary price. Farmers and ranchers should practice “seeing themselves as others see them and not as they see themselves.”

A farm/ranch recreation checklist is shown in Appendix A to help private landowners review their recreation resources (i.e., land, labor, wildlife, capital, and management). The farm/ranch recreation checklist is secondary and should supplement your farm/ranch management plan. Your guiding rule should be to use more intensively and more efficiently what you already have before you worry about what additional resources are needed.

## Location

Your location can be a critical factor in how rapidly a farm/ranch can develop its recreation clientele, what kinds of guests it receives, and the relative cost of marketing. A farm/ranch located along a major highway will receive more repeat guests and a greater number of drop-in guests passing through the area. The national trend is for tourists to take shorter vacations to destination attractions and spend less time wandering over the back roads. Consequently, farms/ranches located off the beaten path must spend more to advertise and make their ranch the destination attraction.

As a general rule, the farm/ranch recreational operation located close to a major population center, such as Kansas City or Wichita, with good, all-weather roads will enjoy greater success than a remote facility.

A significant distance from necessary supplies and services is also a problem because of increased transportation costs. Storage facilities (e.g., freezer space) may need to

be increased. Plan ahead when possible. Getting a plumber out on Sunday to replace the old pump may be impossible or at least very expensive.

However, a remote location can be turned to an advantage with the right kind of marketing strategy. The peace, quiet, and solitude of a remote ranch appeals to a particular kind of guest, so the marketing effort should be directed toward these customers. Imagination, an accurate marketing strategy, and creative advertising helps.

## Land

The concept of land in farm/ranch recreation should include not only the deeded land but also the leased private, state, and federal land and all nearby attractions not even connected to the farm/ranch.

Off-farm/ranch attractions as well as those on-the-ranch should be inventoried and assessed. Capitalizing on local attractions is effective and less expensive than a farmer/rancher trying to provide all of the entertainment. The obvious, such as local dances, rodeos or county fairs, should not be overlooked. It may be well worthwhile for a farmer/rancher to load up a group of guests to go to the local swimming pool, state park, another farm/ranch, or any other attraction if that is what the guests want to do.

If a farmer or rancher sells a five-day deer hunt and the hunter gets his buck on the first day, should the he/she refund 80 percent of the fee, let the hunter entertain himself for four days until his buddies are ready to go, or should the rancher have a backup plan for entertainment?

Why try to provide everything if someone else can do it cheaper and you still benefit by sharing part of the revenue with someone else in the community? It is not uncommon for one farmer or rancher to provide the horseback riding (and the liability insurance) for several nearby ranch recreation operations while you provide the fishing, clay target range, or other guest attractions.

## Farm/Ranch Facilities and Services

Facilities and services needed for farm/ranch recreation should be assessed. Some customers may want to rough it, but most hunters and outdoor recreationalists want to be warm, dry, and out of the wind.

Summer visitors and families with children are even more particular—they want to be clean. Hot showers and



laundry facilities are important. Good food is essential because outdoor activities create an appetite. Food does not have to be fancy, but it should not be monotonous. A good cook is essential. As one experienced hunting preserve operator stated, "Once in awhile, everything goes wrong (weather, dogs, birds, etc.); and when it does, you've got to make it up with the biscuits."

When assessing ranch facilities and resources for recreation purposes, consider which additional enterprises complement and which compete with existing operations. Horses used for roundup and general ranchwork are expensive to maintain but could also be used for trail- and pleasure-riding (if they are really gentle and dependable).

Horseback riding or just seeing horses was the major activity requested by out-of-state visitors in a survey of tourists' perceptions and desires on ranches. Horseback riding also greatly increases the insurance premium, so consider the benefit:cost ratio with the insurance agent before advertising horseback riding.

Microcomputers are becoming much more popular on ranches and are very useful in maintaining inventories of resources, supplies, and facilities as well as assisting in planning and logistics. Several states have computerized range site data normally used in range management planning. Much of this ecological information is directly applicable for assessing game and fish habitat, campsites, and other recreation potential. (Appendix A. Farm/Ranch Inventory and Management Plan).

### *Personnel*

The decision to become involved and the degree of involvement in the outdoor recreational business for a farmer or rancher starts with a self-analysis. How well do you and your family, because they will be involved, like to work with people? The outdoor recreation business is people oriented, whereas ranching or farming is not. Ranchers and farmers are independent by nature. Your privacy will be invaded. The success of any outdoor recreational enterprises is largely based on how well the entrepreneur and his personnel interact with people.

Is your family interested in the enterprise and willing to work with you? The high cost of labor can spell the difference between failure and success, and most outdoor recreational businesses are family managed.

If a rancher or farmer does not want to be involved with people, his best outlet for additional revenue is to lease his land for outdoor recreation to either an individual or to a broker or outfitter. Brokers and outfitters relieve the farmer or rancher from the problem of working with people and are responsible for their conduct while on a given ranch or farm. A lease for some recreational pursuit to an individual is the simplest way of earning extra income for a rancher or a farmer.

Starting a farm/ranch recreation operation will require different and additional jobs to be done. Who will perform these tasks—existing or additional employees? Who will train them? How much should they be paid? Are the necessary skills available? Is the additional labor needed year-round or only seasonally?

These are questions to be answered before starting. Available labor should be assessed just as buildings and wildlife habitat should be assessed. By understanding the expertise and dependability of existing labor, unreasonable expectations can be avoided.

Good seasonal employees can be retained longer. Year-round employees may welcome the additional responsibility and diversity of jobs if they also receive additional compensation.

### *Market Analysis*

Before investing any large amount of funds in an outdoor recreational venture, do a market analysis. From where will your potential customers come? Are there enough people in your market area interested in patronizing your recreational venture? If so, what type of operation will they support. Build your operation to what the market will pay for and not what you think they will pay for.

Business volume is the key to any successful outdoor recreational venture. It may be wise to develop a prospectus of what you plan to develop and obtain reactions from prospective customers, providing they are willing to make a financial commitment. You can change any proposed developments or facilities on a prospectus far easier than when it is a fixed asset on your land.

If you want to become involved in some outdoor recreational enterprise, there are guidelines for you to consider. Learn all you can about the business by visiting other operations, reading publications on the business, and attending state or national meetings on such operations. Talk to the people who operate such ventures. It is well to profit from the mistakes of others.

### *Capital (Enterprise Budget)*

All new farm/ranch recreation enterprises should be evaluated with regard to capital needed for 1) start-up, 2) operating, and 3) cash flow and payback. Different enterprises need different amounts of capital at different times of the year. Recreation enterprises requiring new facilities need large amounts of start-up capital, but less capital to operate once construction is completed. Others, such as labor-intensive operations, require little or no capital for start-up, but much more to operate. Cash flow and payback depend on how many and how soon the customers arrive once the enterprise is in operation.

We generally recommend farmers or ranchers with little or no experience in recreational enterprises start small and

gradually build their operation and a quality reputation. Repeat customers usually provide the bulk of the business; building an adequate clientele may take three to four years regardless of the money spent on advertising. Therefore, a farmer or rancher can learn as he grows and make small, inexpensive mistakes rather than losing it all in the first year or two. Persistence pays.

A well-developed, written business plan is necessary for obtaining capital because most lenders are unfamiliar with farm/ranch recreation operations. In any case, writing a business plan forces the farmer or rancher to consider the expected costs and returns over the payback period of any loan. Once the basic information is compiled, computer spreadsheet programs are available to rapidly simulate different alternatives.

Non-traditional lenders should also be considered as sources of capital. Many states provide funds to stimulate economic development. Tourism commissions may also provide loans or even grants to groups interested in increasing tourism. State and federal incentive programs should also be considered. For example, the USDA Conservation Reserve Program offers incentives for wildlife habitat improvement and allows fee hunting, fishing, and other recreation activities.

### *Legal Constraints*

All relevant federal, state, county, and private legal constraints should be considered. These could include game and fish laws, zoning laws, land use plans, access easements, liens, covenants, and health standards. It may be worthwhile for a farmer's or rancher's attorney to review the property abstract and the recreation business plan. The attorney may need to be educated about farm/ranch recreation to accurately interpret and anticipate relevant legal constraints and their effects on the operation. It may also be appropriate for farm/ranch recreation operators to review existing state legislation and encourage legislators to consider the needs of their farm or ranch recreation industry.

The commercial farm/ranch recreation operator should always remember that when he/she charges for a service to the public, the operator assumes certain moral and legal responsibilities. The moral responsibilities as a host are universal, but the legal responsibilities vary from state to state, county to parish, and from operation to operation and may be influenced by federal as well as state laws.

For example, the recently passed Americans with Disabilities Act federal legislation may even impact your "back-in-the-boondocks, three guests per night" operation under certain circumstances. So, PLEASE consult your attorney—as you would before starting any other kind of public service business.

### *Local Customs*

In farm/ranch communities, local customs may have as much influence on the success of a recreational operation as legal constraints. If free access for outdoor recreation is the tradition in a certain community and one farmer or rancher starts charging for access, former "guests" unwilling to pay the new access charge may increase access pressure on the neighbors.

Several neighboring farmers and ranchers can form either formal or informal cooperatives to handle recreation problems and opportunities. For example, fee hunting services and access provided by a farm/ranch cooperative can provide greater access for hunters when far-ranging big game or waterfowl move out of a hunting area or field. Game management may also be more effective if private land hunting practices are consistent across the herd unit range. Certain services (lodging) can be provided by one or more farms/ranches and other services (horses, outfitting) provided by the neighbors.

Gaining the cooperation of the neighboring farmers or ranchers, local conservation officer, sheriff, chamber of commerce, county commissioners, and others is always worth the effort. These people can be a farm/ranch recreation operator's best friends or his worst enemies.

### *Fit the Enterprise to the Site*

Analyze each farm/ranch (Appendix A) site in terms of natural resources of the area, availability of personal and automotive services, regulations and restrictions which will affect your plans and other factors which might affect your proposed development, such as competitive enterprises, seasonality, and management.

*Natural resources.* Water is essential to recreational development. Do you have water sources of satisfactory quality and sufficient quantity?

- For drinking and sanitation? You may also need pure water for food preparation, food handling, showers, and a swimming pool.
- For fire protection and maintenance needs including sprinkling, spraying, and irrigation?
- For recreation? With enough water, you could provide water-based recreation—swimming, fishing, water skiing, and boating.

List the natural attractions of your site. Such features as good climate, interesting topography, forests, geologic formations, lakes, streams, ponds, and waterfalls will attract people to your proposed development. Other attractions might be historical sites, Indian ruins, or old forts. Mention these features in your advertising.

*Available services.* Most recreation businesses require the following services:

Highways—local, state, and interstate all-weather roads. How close is your proposed development to a city or

major highway? The distance between your site and a population center will affect the volume and kind of business you have.

Sources of fuel—gas, coal, or wood.

Electricity

Telephone

Public transportation—bus, train, airplane, taxi. Are these available near your site?

Other recreation facilities—Are there other recreational attractions in the area? Such established services as stores, bait shops, laundry, auto service and repair, lodging, and restaurants may compete with the business you are considering, or they may complement your business.

An enterprise that offers the same services that you plan to offer will be competitive when demand for the service is low. If you are considering a camping facility, and there are other attractions nearby with inadequate or no camping facilities, the other attractions will be complementary to your business. A unique site or service will give you a selling point and help your business.

*Community facilities.* Many people on vacation like to be near such community facilities as hospitals and churches. They may want the professional services offered by doctors, dentists, or veterinarians. If your site is near such facilities, let prospective customers know about it.

### ***The Hunting (Outdoor Recreational) Lease***

The benefits of a hunting lease are also applicable to other forms of outdoor recreation in demand by the public. The wording within a given hunting lease can be adapted to other forms of outdoor recreation with the help of a lawyer.

Recognition that recreation is the key to successful operation of a hunting lease. The hunter wants a pleasant experience, and the quality of the lease agreement is measured by the degree of his satisfaction. To insure satisfaction, both the hunter and rural landholder should agree on what is included in their lease.

Hunters want exclusive hunting rights in return for their payments. Farmers or ranchers want to regulate the hunter's use of their land and to supplement their income.

Hunting leases have existed in some states for more than 50 years. Early leases were almost exclusively for waterfowl or big game hunting. Most of these early hunters were first-generation, off-the-farm people familiar and sympathetic with the problems of farmers and ranchers. Common backgrounds with the early hunters allowed for a satisfactory verbal agreement.

Now only a small percentage of hunters and rural landholders have similar backgrounds. The gap in awareness and understanding of the problems of each group is growing. A written lease provides a basis for discussing provisions affecting both hunter and landholder.

Fee hunting is a business, and a lease is a business

contract or agreement. The purpose of the lease is to help assure there are no misunderstandings between the landowner and the hunters. The lease provides the opportunity to identify responsibilities, rules or restrictions before any money is exchanged, or activities start. It does not mean problems won't develop, but it certainly informs both parties as to what is expected and what is or is not allowed. In addition, hunters may have more respect for the land, landowner, and the rights they purchased if they are treated in a businesslike manner. Leases can and should be negotiated and changed as experience is gained or situations change. Appendices B, C, and D are examples of different lease agreements.

### ***What Is a Hunting (Recreational) Lease?***

A hunting (recreational) lease is an arrangement whereby the landowner transfers the right of ingress on his property to the hunter for the purpose of hunting in exchange for a fee. Legally, the responsibility of the landowner, as lessor, is as follows: "A tenant is in fact a purchaser of a leasehold estate in the land or premises demised and is entitled during its legal continuance to the exclusive use and possession of the premises as though he had acquired a fee simple title, unless limited or restricted by the terms of the lease. Because of this basic fact, it is imperative that the landowner incorporate specific provisions in the lease agreement that set down and fully describe all of the rights in the premises retained by the landowner as well as all of the rights and obligations delegated to the lessee."

### ***Special Laws?***

In some states (Texas), the landowner (lessor) is required to purchase a "shooting preserve license" from the state Parks and Wildlife Department. In Texas, a shooting preserve is defined as any premise leased for hunting purposes, which is a separate, unconnected, and distinct tract of land with a continuous and unbroken boundary. Your local conservation officer should be able to answer any questions concerning any necessary licensee for fee hunting.

### ***The Best Lease***

A written agreement is the best insurance against misunderstanding between hunter and landholder. It can clearly spell out conditions of the agreement and provide an outline for discussion on mutual points of interest before a lease is made. A copy of the written agreement should be provided for both hunter and landholder.

*Why have a lease?* Why go to the trouble of writing up a lease? There are at least three excellent reasons.

First, developing a lease makes you think hard about just how you want to run your fee-hunting enterprise. It is,

in effect, an exact description of what you want to receive (income, protection, development of your land) and what you are willing to exchange for it (hunting rights, trespass privileges, services).

Secondly, a written lease is by far the best way to avoid misunderstandings between landowner and hunter. If agreements are on paper, problems such as hunters shooting too close to animal pens or dwellings (possible off-limits areas) are less likely to occur. Discussing the lease with prospective clients also gives you a chance to evaluate their character and philosophy before making a commitment.

Thirdly, a written lease may offer some legal protection against liability. Although there have been few cases to test this protection, it is certain that, should you be sued, a clearly written lease is a far better defense than a word-of-mouth agreement.

### *Types of Hunting Leases*

The variations in lease agreement can be generally grouped into four types:

*A year-round lease* usually includes all hunting privileges and often includes more recreational privileges than just hunting. Usually a small group is involved. Often friendships develop, and the hunters feel like proprietors of “their lease.” Generally, good relations exist between hunter and landholder. Some disadvantages exist. Since few hunters are in the group, game may not be adequately harvested in areas of high game density. Because of the year-round duration of the lease, the landholder may have hunters on land at undesirable times, such as lambing or harvesting periods.

*A lease of limited duration or seasonal lease* may range from the entire legal season on a specific species of game to one- or two-week intervals within the legal seasons. This retains some advantages of having small groups on the land at a time but gives greater flexibility in scheduling hunters and harvesting different species. For instance, a place might be leased for two weeks of dove season to one group and leased to another group for the first week of the duck season.

*Day hunting* requires greater contact with people and more extensive advertising. Since day hunters give short notice of desire to hunt, someone must be available throughout the season to handle hunters. Day hunting is good for large numbers of hunters and probably is most useful to places which can tolerate high hunter densities.

*A guided hunt or one of a few days* in which the hunter is guided until he gets what he desires. In this specialized hunting, the guide works full time with few hunters. This method is used somewhat for deer but more commonly for big game.

The leasing period you choose depends partly on the type of game (dove leases are usually on a daily, per-gun basis; deer leases are seasonal; duck or geese may be daily

or seasonal) and partly on what is most convenient or profitable in your situation.

Short-term leases give the landowner more control over the property, because policies can be changed or the land withdrawn from hunting on short notice. Also, higher fees can usually be charged for daily leases. On the other hand, short-term leases require extra attention—more contact with people, more advertising, and more bookkeeping—to keep the land leased during a hunting season, and the total income for a season is not guaranteed.

Seasonal and annual leases tend to involve fewer hunters and less paperwork. A long-term relationship can develop with the same hunters, and protection of the land against trespass is usually better. These leases assure the landowner of a fixed, guaranteed income. On the negative side, seasonal and yearly leases limit the ability of the landowner to change policies, and the potential income is usually not as high. You may want to lease hunting privileges to a group for longer than one hunting season or year. Seasonal or yearly leases are prudent until a good cooperative relationship is established, then a longer lease (even five years or more) may be desirable. Some hunting clubs invest in considerable improvements to wildlife habitat and hunting facilities where they have long-term leases. This benefits both the lessee(s) and the lessor. Also, farmers or ranchers often ask for and receive the entire multi-year lease payment up front. With compound interest, that income will be larger than it would be from seasonal or yearly lease payments.

A 1980 survey showed that nationwide the majority of hunting leases (69 percent) were annual, 22 percent were seasonal, and 4 percent were daily. Since each situation is different, a lease agreement should be custom designed to fit landholder’s and hunter’s requirements. For a landholder leasing for the first time, a limited duration lease would probably be the most satisfactory arrangement. This method enables him to gain experience necessary to determine what will best fit his situation. Appendix E summarizes the pros and cons of the day lease, season lease, year-round lease, and brokers or outfitters hunting lease.

### *Developing a Lease*

You should consider working with your attorney in developing a lease for your property. Your attorney will need to make it all fit within the law.

The following is a general description of the various sections of a lease and should help you in developing a lease. **Please note that these are only suggestions and not legal advice.**

1. *Introduction.* This section should list the names of the persons involved in the lease—the landowner (lessor) and the hunter (lessee), county and address of the farm being leased. Lessees may include individuals (one or

several), informal hunting groups, organized hunting clubs, hunting preserve operators, corporations (for employee and customer use), or outfitters/guides. You should request that one person be assigned to represent a group.

2. *Purpose of the lease.* This should describe the purpose of the lease—hunting, fishing, camping, general recreation, etc.

3. *Description of the land involved in this lease.* This should be a clear description of the area included in the lease. Attach a map to avoid any misunderstanding of property lines or areas excluded from the lease. Specific no-hunting areas (pond, around dwellings, next to neighbors if potential problems might exist or develop) should also be included.

4. *Terms of the lease.* Starting and ending dates should be defined, or state and federal season dates can be used. Cover what will happen if a season is prematurely closed for some reason. Is money to be refunded or carried on to next year? What hunting methods (guns, bows, dogs, traps, stands) will you permit? guest privileges?

5. *Amount of the rent and payments.* How much is the total rent, what are the payments, and when are they due? Do you require an advance deposit?

6. *Conditions of the lease.* List what is or is not agreed to as terms of the lease. This is your opportunity to clearly identify the activities you will allow the lessee to conduct on your land. You can lease hunting rights for one, two or more species of game, and different rights can be leased to different parties.

7. *Remedies for breach of lessee's responsibilities.* This section should describe those conditions which will authorize you, the lessor, to cancel the lease. This should also describe any loss of rental payments. Conditions under which the lease may be canceled by the landowner should include: failure to make lease payments or perform duties, unsafe or unsportsmanlike conduct, property damage, failure to obey state hunting regulations, and encroachment on neighbors.

8. *Lessor's responsibilities.* Clearly cover what you have agreed to do or provide for the comfort and convenience of the lessee and any improvements you will make for the lessee. There should be a clear understanding of what landowner is providing—hunting areas and access; electricity, water and space for camper; boat and equipment storage during season or also after season; etc.

9. *As is clause.* Lessee agrees to take the premises as it is in its present condition.

10. *Anti-Assignment.* State if you will or will not allow sub-leasing.

11. *Termination.* Clearly state when the lease ends and in what condition the land is to be left. Are blinds, tree stands, etc. to be left or removed? Conditions for renegotiation and renewal?

12. *Liability or indemnity release clause.* Work with an attorney on this section, but consider indemnity clause, hold-harmless clause, safety rules.

13. *Lessee's responsibility.* State what the lessee's responsibility or liability is for any damage to land, structures, people, farm animals. You may want to require that lessee(s) obtain liability insurance to protect themselves and you.

14. *Closing formalities.* This section provides the formal wording for a witness or notary to sign.

### **Additional Lease Provisions**

Each hunting lease must strike a balance between security and flexibility and between the desires of landowner and hunter. The following are some additional provisions or considerations you may or may not wish to include in your lease; there may also be others which fit your needs. Develop a draft lease and ask a sportsmen's or hunting club to give you input.

#### **Safety**

- No hunting under the influence of alcohol or drugs.
- Sign-in/sign-out requirement.
- Children under 16 accompanied by adult.
- No shooting in the direction of buildings or crossroads.
- Big game hunters must wear blaze orange (regardless of state laws).
- Hunter education course required.

#### **Care of property**

- Access to hunting area, parking, where and when vehicles are allowed over the fields.
- Improvements, such as wildlife plantings or hunting facilities, that lessees are allowed to make.
- Rules on opening and closing gates, crossing fences, etc.
- Restrictions on fires, stoves, grills.
- Restrictions on camping, fishing, or trapping.
- Rules on plinking, target shooting, sighting of rifles.
- Restrictions on construction or use of structures (blinds, stands, cabins).
- Security deposit, payment for damages.
- Trash removal.
- Use of farm/ranch operations buildings, toilets, water supplies.
- No nails in trees or tree cutting.

#### **Miscellaneous**

- Number of hunters permitted at one time.
- Hunting pressure (number of hunting days).
- Specific days (and hours) when no hunting is allowed.
- Specific concerns about baiting, observing shooting hours, species protection, etc.
- Number limit on guests.
- Members must accompany guests.
- Owner retains some hunting rights for family, friends.
- Cattle grazing rights for owner.
- Standards for in-kind work.
- Hunters must record and report game harvested for your records.

- Establishment and/or use of food plots or bait stations.
- Hunters will maintain posted signs.
- Restrictions on fishing, camping, or trapping.
- Blinds to be used, and who will furnish them?
- If a cabin or other shelter is built by lessee, who will provide utilities?
- Who owns the shelter that is built by lessee?

### ***Pricing the Lease***

The market value of a hunting lease is uncertain and pricing recreational activities is covered in Chapter 25, Marketing Farm/Ranch Recreation.

You can charge a higher fee if your land has high populations of game, is close to an urban area, or has some special features or services (waterfowl hunting with blinds, for instance). Fees for short-term leases are usually higher than those for seasonal or annual leases. If anyone in your area is successfully leasing hunting land, you can get a good idea of what the market will bear from their experience. Recent leasing fees from other states may also help you decide what to charge.

Rather than (or in addition to) monetary payment, you may choose to have the lessee perform certain duties or carry out conservation practices on your land. The most common duty is probably protection of the land against trespass. In return for hunting privileges, you may ask that the lessee maintain posting; watch for signs of entry, such as litter and damaged fences, and warn trespassers during the hunting season.

Many groups of hunters will actually enjoy the opportunity of doing farm/ranch work in exchange for hunting privileges, if certain conditions are met. The work should be something unusual, reasonably safe, and not more strenuous or of such duration that the fun wears off, and the work becomes slave labor. One "people management" approach is to insist that you, as landowner, work with the group on the project so you can get to know them. Actually, you will be providing supervision to see that the job is done the way you want it done, and there is less chance the group will goof off or act in an unsafe manner.

Conservation practices are especially interesting payment-in-kind activities to hunters and benefit both the landowner and the hunter. They improve the value of the land and the quality of hunting. Some of these practices include:

- planting food plots and cover strips
- tree planting, including fruit, nut, and mast-producing species
- creating brushpiles
- rip-rapping eroded banks
- planting ground cover beneficial to wildlife on eroded areas
- building check dams across deep gullies

- reseeding seldom-used trails
- planting hedgerows
- prescribed burning
- building and placing nest boxes for ducks and geese
- timber stand improvement
- plant evergreens in field corners

If you decide on non-monetary payment, be sure that the duties or practices are carefully described in the lease, the dates they are to be carried out (preferably in advance of the hunting), and who will pay for the materials.

### ***Leases for Other Activities***

Leasing land for uses other than hunting is a promising possibility. The 1985 Fishing, Hunting and Wildlife-Related Activity survey showed that over half of all adult Americans actively participated in non-consumptive wildlife-related activities, such as feeding, observing, or photographing wildlife; camping; and fishing.

### ***Bed and Breakfast Facilities***

Whether a home can be adapted to serve a bed and breakfast function is a fundamental concern. How many rooms can be diverted to the use of guests? Will their locations ensure the privacy of the visitors? Can they accommodate special needs that the guests may have? Will they meet local and state safety and health standards?

Before starting a bed and breakfast, the family needs to learn about any housing laws and regulations that might apply. Also, they need to determine whether any major improvements on their house will be necessary. Remodeling and improvements can be expensive and may be financially impossible or unwise. Unless the owners plan to have more than a few guests at a time, however, little or no remodeling or redecorating should be necessary.

Some modifications may be required by law. Exits must be readily accessible in case of emergency. For an "AAA" (American Automobile Association) rating, each sleeping unit must have at least two exits.

Smoke detectors must be installed and in working order. At least one 5-lb., BC-rated fire extinguisher must be immediately adjacent to all kitchen or food service areas. Liquid propane burning appliances are restricted from use below the grade level of the house. These kinds of modifications to an existing home are usually not too expensive.

The cost of utilities is not a significant factor in small operations. If the operation is designed to accommodate large numbers of guests, however, consideration should be given to supplemental heating and cooling equipment that might be needed during peak seasons.

*General appearance.* A clean, attractive facility is most appealing to guests. Their first impression is often long-lasting. The smell of a fireplace, of freshly baked bread, or spicy foods add to the home atmosphere. Fresh scents,

spices, and flowers are appealing touches that enhance the first impression of guests.

Living and recreation areas, patios, and other places where guests may spend time need to be attractive and convenient. Play areas and toys for children should be clean and safe. These areas will be shared by both family members and guests and should be planned accordingly.

*Bedrooms.* The bedroom is usually the most important room for guests, so bedroom furnishings need special attention. Comfortable beds and fresh linens are essential for bedrooms. Firm mattresses should be provided.

All linens should be replaced after the overnighters leave. Guests staying two or more nights should expect clean sheets and pillowcases at least every other day. The owner has the responsibility of making beds, emptying waste baskets, and cleaning carpets and floors each day.

Pillows and bed coverings also add to the appearance and comfort of the bedroom. Some people may prefer feather pillows; others may be allergic to feathers. Having both fiber-filled and feather pillows is convenient. Attractive, washable bedspreads should be selected. They should be laundered each time guests depart.

Handmade quilts and comforters can complement certain rooms. Some guests may even want to purchase such an item. This type of sale can be another source of income for bed and breakfast operators.

As guests often spend free time in their bedrooms, comfortable chairs should be part of the decor. Lamps should furnish sufficient reading light.

Little extras also add an informal and homey touch: candy mints, fresh flowers, a Bible, and popular magazines. If a TV set is provided, a local TV reference guide should be in the room. A current list of local events provided by the chamber of commerce and a regional newspaper are usually appreciated. A telephone and telephone directory in the bedroom are an added convenience for guests.

Comment cards supplied in each bedroom will allow the guests to express their expectations and comments. A small box or basket in the bedroom or hall into which the cards may be placed allows guests to express themselves anonymously if desired. Guests often make helpful suggestions. Many of their comments are complimentary, letting operators know their planning has been successful and appreciated.

Closet space, hangers, etc. are important, especially for guests staying more than one night. Plastic hangers tend to cause less scratching on closet wood and paint. Covered hangers, though expensive, add to the overall attractiveness.

*Bathrooms.* One of the important assets of the bed and breakfast home is the private bathroom. Most Americans prefer private to communal bathrooms and are not elated to find they have to share the bathroom with other than family members. If possible, prospective operators should invest in

guest bathrooms. In time, if the business prospers, the cost can be recovered. Americans are willing to pay an additional \$5 to \$7 per night for their bathroom privacy.

Guest bathrooms should be equipped with soap holders and fresh soaps, end-folded toilet paper, non-skid paint or mats in the tub, toothbrush holders, and drinking glasses or cups. Extra towel bars need to be installed, or, if desired, they can be placed in the bedrooms. Guests should be provided with clean towels of good quality every day.

The bathroom should have sufficient electric outlets and an overhead light. Bathtub and shower joints may need to be caulked. Stains can be removed from old tubs with bleaching solution, and mildew removed from shower curtains with saltwater. Old paint should be removed and new paint applied.

Loose wallpaper can be reattached with a hot-glue gun. Loose tiles should be cemented or replaced. Room deodorizers should be placed in the room. For AAA approval, each bathroom door must have an inside lock.

If an existing bathroom is to be shared by the family and the guests, special care should be taken. Family members, particularly children, should be cautioned to be tidy in their use of the bathroom. The room should be thoroughly cleaned every day by the owners.

*Kitchens and dining areas.* Traditionally, bed and breakfast operations serve a full home-cooked meal. Today, however, the trend is toward a continental breakfast—juice; sweet rolls; and milk, cocoa, tea, or coffee. The food is self-served or served by the host. In some establishments, guests prepare their own breakfasts. Breakfast can be served in the kitchen or dining room, depending upon the facilities.

Regardless of the method or plan of serving, tables should be set up with care. China and silverware should be laid out attractively. Table centerpieces contribute to a pleasant setting. Hosts usually interact with their guests while serving the beverages. They may choose to sit at the same table and visit. This also adds to the homey environment.

If a full home-cooked meal format is selected, meals should be carefully prepared and served. Although operators should try to buy food supplies wholesale, economizing too much on food costs may be a serious mistake. People are willing to pay good prices for good food and will resent poorly prepared breakfasts. The best food usually comes from the best ingredients.

Some establishments develop specialties for which they become well known. Freshly baked cinnamon rolls, sausage or bacon, biscuits and gravy, fresh orange juice, homemade jams and jellies, and cream and butter can combine to make a breakfast more delectable than that served by top restaurants. In today's quick-frozen, fast-food world, excellent home-cooked meals become real treats as well as drawing cards.

According to state health regulations, all food served or provided in a bed and breakfast must be obtained from an approved source: pasteurized milk, USDA-inspected meat, and other foods known to be free from contamination and disease. The food must also be processed and handled sanitarily.

## ***Hunting Preserves***

The number of hunters is increasing yearly, and more and more are willing to pay for hunting privileges. Consequently, here is another possible source of income for the landowner—the hunting preserve.

### ***What is A Hunting Preserve?***

There are several definitions, but for our purpose, a hunting preserve is “an area owned or leased on which pen-reared game is released for the purpose of providing hunting over an extended season of three or more months under license by the state wildlife agency.” In Kansas, these areas are called “Controlled Shooting Areas.” Contact KDWP for permit information and rules and regulations about controlled shooting areas.

The basic types of hunting preserves are commercial and non-commercial. Commercial hunting preserves have a single purpose: to provide profit for the owner/operator who furnishes quality hunting to those willing to pay for it. They can be open to the public on a daily fee basis or open to members only, or a combination of the two. Non-commercial hunting preserves are meant to provide quality hunting for a group of hunters on a non-profit basis. The hunters on such preserves do all of the work or hire the personnel to do it. Both commercial and non-commercial preserves can be operated on either owned or leased land.

Hunting preserves may feature one or more species of pen-raised game birds, such as ring-necked pheasants, bobwhite quail, chukar partridge, mallard ducks, and to a lesser extent gray partridge and wild turkeys. The ring-necked pheasant has proven to be the easiest game bird to

manage for quality hunting. Game bird breeders have learned to produce ring-necked pheasants that simulate the field behavior of wild birds shortly after being released through selective breeding and flight conditioning.

## ***Commercial Hunting Preserves***

The success or failure of a commercial hunting preserve depends on a thorough analysis of all the factors discussed earlier in this chapter as guidelines to the success of any farm/ranch recreational enterprise. Success will largely depend on planning, personal interests beyond liking to hunt, aptitudes, and skills. The hunting preserve operator must be a jack-of-all-trades and a master of most. He must understand hunters and hunting, dog training and handling, the management of pen-reared game birds, farming, personnel management, public relations, business administration, and shotgun shooting.

Few hunting preserves provide an adequate annual income. The successful operators are those who obtain a year-round income from a combination of seasonal activities, such as boarding and training dogs, game bird breeding, farming, ranching, camping, fishing, picnicking, and clay target shooting. Sporting clays, a clay target shooting game, has provided an off-season income for some hunting preserve operators.

Most operators who fail in the hunting preserve industry are people who tried to shortcut the tedious program of study, analysis, and self-examination. The human factor of work, management, and judgment are the greatest contributors to success and the hardest to evaluate.

For more detailed information read: *Hunting Preserves for Sport or Profit* by E. L. Kozicky, Caesar Kleberg Wildlife Research Institute, Texas A&M University—Kingsville, Texas 78363. 1987. 210 pp. \$24.95.

Another source of current information on hunting preserves management is: The North American Gamebird Association, Cayce, SC 29171.





## Questions for Chapter 24

1. What is a farm/ranch inventory checklist?
2. Why is it necessary for a farmer or rancher to do a thorough self-analysis before becoming involved in the recreation business?
3. Why should one do a market analysis before going into the recreation business?
4. What are some of the natural resources and services in an area that one should evaluate before going into the recreation business?
5. Why is it important for a landowner to have a written lease agreement with recreationists?

### Questions for Chapter 24 (continued)

6. Name three points on safety that should be considered in a lease. Name three points on safety?

7. Name three major factors to consider regarding housing for a bed and breakfast operation?

8. What is a hunting preserve?

Name \_\_\_\_\_

## Appendix A. Farm/Ranch Recreation Inventory and Management Plan

Owner/Manager: \_\_\_\_\_

### *Primary Assumption.*

A farm/ranch recreation operation is secondary to the livestock and/or crop production operation.

Use all of the Farm/Ranch Management Plan Outline at the beginning as a basis for the Ranch Recreation Inventory and Management Plan; the plans are then combined as one document.

### *Inventory Philosophy: Optimization, Quantity versus Quality*

What do I have?

What do I want?

What do the recreationists want?

Ranch Recreation Objectives

1. Personal
2. Family
3. Farm/Ranch
  - a.) Maximum net profit
  - b.) Quality experience for the recreationists

### *Positive and Negative Factors*

- assess and solve bottleneck—law of the minimum, weak link
- factors affecting wildlife populations
- turn a problem into a profit—theory of opposites

### *Personal Characteristics*

1. Interpersonal relations
2. Privacy-oriented
3. Independence
4. Tolerance
5. Special talents and abilities
6. Willingness to learn and ask advice
7. Technical knowledge
  - a) Production
  - b) Business
8. \_\_\_\_\_
9. \_\_\_\_\_

### *Outside Assistance*

1. Neighbors
  - free access tradition?
2. Sheriff
3. Conservation officer, wildlife biologist
4. Extension agent
5. Soil Conservation Service
6. County commissioners
7. \_\_\_\_\_

**Labor**

Employees—skills, additional training, willingness, increase in salary

1. Full time
2. Part time
3. Accountant
4. Attorney
5. Lender
6. Consultants
7. \_\_\_\_\_

**Capital**

Enterprise budget  
Start-up  
Operating  
Cash flow and payback

**Land (Landscape)**

Use Farm/Ranch Management Plan, Part I, add data and explanations that pertain to a farm/ranch recreation operation and are independent of a livestock/crop operation. Wildlife management principles—substituting recreationists for wildlife in regard to the optimum combination of habitat types: area per type, edge, interspersions, juxtaposition, edge, and minimum area.

Soil

- land productivity

Water

- uses, attractions, legal rights

Vegetation and Habitat Types

- rangeland
- pastureland
- cropland
- riparian
- woodland wildlife management principles
- substituting

Space

- privacy
- solitude
- distance

Aesthetics

- beauty, awe, excitement, peace

Access

- distance from supplies, services, customers

**Wildlife**

- presence, population numbers and ratios, habitat grade, and potential

A. Inventory factors

- species number: total count, ratio techniques, trends, key areas

1. Sex ratio

2. Age ratio

3. Trophy quality

- antler size, age, nutrition, fish size, condition, supplementation

4. Behavior

- location, home range, daily habits, secretive, response to public pressure

B. Market demand for species

- consumptive, nonconsumptive, seasonality

- C. Minimum number
  - maintain population, economical to manage, annual harvest
- D. Potential for increase?
  - minimize negative factors
- E. Inter• and intra-species competition
  - wildlife x wildlife?
  - wildlife x livestock?
- F. Habitat improvement potential
  - food, cover, water, privacy

### *Compensation Strategies*

1. No fees or other compensation
2. Protection from further ingress
3. Performance of ranch or habitat improvement
4. Daily fees for non-consumptive uses
5. Consumptive use compensation leases
  - individual, club, corporationType
  - day
  - season
  - year
  - broker, manager, outfitter
6. Hunting preserve



## Appendix B. Hunting Lease Agreement

### (Simple Lease No. 1)

THE STATE OF (state); COUNTY OF (county).

KNOW ALL MEN BY THESE PRESENTS:

(Basic Provisions)

This Hunting Lease Agreement is made by and between \_\_\_\_\_(Landowner), hereinafter called "LESSOR", and (Hunters), hereinafter called "LESSEES".

1. LESSOR does hereby lease to LESSEES, for the purpose of hunting (specify game animals) during the season established and in accordance with the laws, rules and regulations of the (state wildlife and parks department) the following described premises located in \_\_\_\_ County, (state):

(legal description)

2. The term of this lease is for the (year) (game animals) hunting season, which season is scheduled to begin on or about the \_\_\_\_ day of (month) and ending on or about (month, year).

3. The consideration is to be paid by LESSEE to LESSOR at \_\_\_\_, County, (state), is \$(amount) in cash, one-half of the total to be paid on or before (day, month, year), and the balance to be paid on or before (day, month, year). Failure to pay the second installment shall thereupon terminate and cancel the lease and the amount already paid shall be forfeited as liquidated damages for the breach of the agreement.

4. In the event any hunter paying consideration for this lease fails to execute the same, then those hunters executing the agreement shall be deemed as agents for such other hunters and responsible for all obligations hereunder imposed upon each individual member of the party. Violation of any agreement or obligation herein by any member of the hunting shall cause the lease thereupon to cease and terminate as to the entire group and all rights granted hereunder forfeited.

5. LESSEES understand and agree that the lease premises is not leased for agricultural and grazing purposes and, consequently, takes subject to the rights thereof. LESSEES further take subject to the rights of any oil, gas and mineral leases presently in existence on the lease premises or that may be executed during the term of this lease. LESSEES and LESSOR agree to cooperate so that the respective activities of one will not unduly interfere with the other.

6. LESSEES shall take the proper care of the lease property, the house, and all other improvements located thereon, and shall be liable to LESSOR for any damage caused to domestic livestock, fences, or other property of LESSOR due to the activities of LESSEES or their guests exercising privileges under this lease.

7. LESSEES further covenant that they have inspected the described property and have found the premises to be in an acceptable condition and hereby waive any right to complain or to recover from LESSOR in the future relating to the condition of the lease property or any improvement located thereon.

8. LESSEES agree to protect, defend, indemnify and save LESSOR harmless from any all liability, claims, demands, causes of action of every kind and character, without limit and without regard to the cause or causes therefor of the negligence of any party or parties arising in connection herewith in favor of (1) any lessees hereto, (2) any person who comes on the lease premises with the express or implied permission of Lessees. The above indemnity shall apply even if LESSOR'S sole negligence is the cause of such accident, injury or damages.

9. If LESSEES default in the performance of any of the covenant or conditions hereof, then such breach shall cause an



immediate termination of this lease and a forfeiture to LESSOR of all rentals prepaid. In the event a lawsuit arises out of or in connection with this lease agreement and the rights of the parties thereof, the prevailing party may recover not only actual damages and costs but also reasonable attorney's fees expended in the matter.

[Examples of Optional Clauses]

1. Each individual hunter shall be privileged to take (game animals). LESSEE shall complete and accurate records of all game taken and report the same to LESSOR at the end of the hunting season.
2. No hunter shall be allowed to:
  - a. Bring any dog, cat or other domestic animal nor any motorcycle on the ranch;
  - b. Shoot a firearm from a vehicle;
  - c. Make a fire outside camp, leave open gate found closed or close a gate found open;
  - d. Enter upon, either by vehicle or foot, or shoot at game located upon any other pasture than that designated above;
  - e. Drive a motor vehicle other than along established roads.
3. LESSEES and their designated parties shall be permitted to construct blinds and feeders on the lease premises and shall be permitted to remove same upon termination of this lease, provided, however, no blind shall be constructed in a manner that damages any of the trees located on the lease premises.
4. LESSEES shall not cut or otherwise destroy any living tree located on the lease premises without permission of LESSOR, but they shall be permitted to use dead wood located on said premises.
5. LESSEES covenant and agree to permit no material waste on the premises, to remove all material refuse and litter they deposit thereon, and particularly LESSEES covenant and agree not to throw out beverage containers on the lease premises.
6. LESSEES hunting under this lease shall not climb, hunt or otherwise use any windmill located upon the lease premises.
7. In period of wet weather, where the ground is sufficiently wet that motor vehicles will make substantial ruts, LESSEES agree to drive only on existing ranch roads.

EXECUTED this \_\_\_\_ day of \_\_\_\_\_(month), \_\_\_\_ (year).

LESSOR:

LESSEES:

1. \_\_\_\_\_
2. \_\_\_\_\_
3. \_\_\_\_\_
4. \_\_\_\_\_
5. \_\_\_\_\_
6. \_\_\_\_\_
7. \_\_\_\_\_
8. \_\_\_\_\_
9. \_\_\_\_\_
10. \_\_\_\_\_

1. \_\_\_\_\_
2. \_\_\_\_\_
3. \_\_\_\_\_
4. \_\_\_\_\_
5. \_\_\_\_\_
6. \_\_\_\_\_
7. \_\_\_\_\_
8. \_\_\_\_\_
9. \_\_\_\_\_
10. \_\_\_\_\_

## Appendix C. Hunting Lease

### (Simple Lease No. 2)

This LEASE made and entered into this \_\_ day of \_\_, 19\_\_, between \_\_\_\_, hereinafter called the “LANDOWNER,” and (the person or group to whom hunting rights are being released), hereinafter called the “LESSEE.”

WITNESSETH THAT:

1. LANDOWNER for and in consideration of the rents and covenants hereinafter referred to does hereby lease unto LESSEE for the purpose of hunting white-tailed deer the following premises: (describe the tract of land to be leased).
2. The term of the lease will be for the period of one year, beginning on \_\_\_\_, 19\_\_, and ending on \_\_\_\_, 19\_\_.
3. LESSEE shall pay upon unto LANDOWNER a rent of \$\_\_in cash, one-half of the total to be paid on or before \_\_, 19\_\_, and the balance to be paid on or before \_\_\_\_, 19\_\_.
4. LESSEE will abide by the State and Federal laws regarding the hunting of (game animals) and will report all animals killed to the LANDOWNER so that records may be accurately kept.
5. LANDOWNER reserves the right and privilege for a maximum of 3 persons from his family to hunt and fish on the leased property at any time.
6. LESSEE may permit guests to accompany him upon the leased property for the purpose of hunting (game animals), but the number of guests the LESSEE may invite upon the leased property shall not at any one time exceed 2.
7. LESSEE will not cut, injure, or destroy any trees, crops, roads, fences, buildings, or other improvements located on the leased property, and LESSEE agrees to compensate LANDOWNER for all damages so caused as determined by LANDOWNER. Vehicular travel is limited to established roads now located on leased property.
8. LESSEE will not assign this lease or sublet the leased property or any part thereof without the written consent of LANDOWNER.
9. LESSEE agrees to save harmless LANDOWNER against any and all claims of loss, damages, liabilities, or other expense of any nature, character, and kind that may arise out of, be connected with, or as a result of LESSEE’s occupancy and activities on the leased property.
10. If LESSEE defaults in the performance of any of the conditions or covenants hereof, then such breach shall cause an immediate termination of this lease and a forfeiture to LANDOWNER of all rentals prepaid.

LANDOWNER	DATE
-----------	------

LESSEE	DATE
--------	------

(Space should be provided for each lessee to sign)

WITNESS	DATE
---------	------



## Appendix D. Model Lease Agreement

Note: the following agreement should not be copied from this publication word-for-word and used. It must be adapted to a specific situation by the landowner. Consultation with an attorney is recommended.

Sir/Madame/Gentlemen:

I, (name of landowner, lessor), for the sum of \$   , payable in advance, grant to (name of organization or individual, lessee.) the right to hunt and shoot, subject to the stipulations and conditions hereinafter set forth and only at such times as hunting and shooting are permitted by the laws and regulations of the United States and the State of (state) in force and effect, on the tract or tracts of land described as follows (description of tract-county, road #, deed #, acres, other data):

### STIPULATIONS and CONDITIONS of THIS LEASE AGREEMENT:

1. If the lessee is an organization composed of several members, the terms of this lease and its stipulations and conditions shall apply to each and every member. The terms of this lease and its stipulations and conditions shall also apply to any and all guests of the organization and its members.

2. If the lessee is an organization composed of several members, the term "lessee" shall apply to the organization and to any or all of its members.

3. The rights herein granted are restricted solely to hunt and shoot.

4. Hunting and shooting are prohibited within 200 yards of any occupied dwelling or within any designated safety zone.

5. The right to hunt and shoot is subject to any rights that the landowner may care to exercise over the Lands. Agricultural and forest management activities will take precedence over hunting activities.

6. The lessee will post the boundaries of the leased property with durable signs that include the name and address of the lessee.

7. The lessee will exercise due care to prevent forest fires on the property; will not cut, or destroy timber growing on the leased lands; and will not make or suffer any waste thereon.

8. The lessee will extinguish any fires on the leased land, without cost to the landowner, if the fire occurs when he/she/they are using the tract.

9. The lessee will conform strictly to local, state and federal laws and regulations governing hunting and shooting; and the lessee will report all violations of laws and regulations, and assist law enforcement officers. If the hunting season begins after the date this lease commences, or ends prior to the termination of this lease, the term of this lease will be reduced to conform with applicable regulations.

10. If the lessee is a club or other organization composed of several individual members, each individual member is bound by the terms of this lease and its stipulations and conditions, and failure to comply will subject the club or organization to liability under the provisions of Paragraph 11 herein. All members shall have in their possession a membership card valid for the current season listing his name or her and signed in ink by the club president or his representative. Others using the property with the permission of the club or organization will be issued a signed card granting permission to hunt and shoot on which card the permittee will indemnify the lessor according to provisions of Paragraph 11.

11. The lessor assumes no responsibility for the safety of the lessee in the exercise of the rights granted by this agreement. The lessee hereby assumes all such responsibility. The lessor shall not be liable for any injury or death incurred by the lessee either while on the leased land or while making use of right-of-way to or from the leased land or while making use of any transportation facilities which may be provided by the lessee, form, or over the leased land. The lessee will indemnify and hold harmless the lessor from and against any claim, loss, cost, or damage whatsoever cause by or arising from the operations of the lessee on the leased land or failure of the lessee to comply with any of the conditions of this lease, including failure to obtain all necessary signatures as set forth in Paragraph 10 herein. Each member of the lessee organization will be jointly liable to indemnify and hold the lessor harmless pursuant to this Paragraph 11.

12. Any and all campsites, clubhouse grounds, or gathering places on the property shall be kept free of litter. Receptacles for trash may be placed within the leased areas and emptied by club members at the county landfill or in county-serviced dumpboxes.

13. Vehicles shall be parked in designated areas. Use of roads shall be restricted to dry weather conditions. The lessee shall honor all locked gates.

14. Should the lessee fail to comply, in the opinion of the lessor, strictly with the terms of this lease, the lessor reserves the right to cancel this lease forthwith without any liability whatsoever.

15. The lessor may cancel this lease even though the lessee has complied with its terms; but the lessor will refund to the lessee the proportionate part of the \$\_\_ paid, as the same shall bear to the unexpected period, without further liability whatsoever to the lessor.

16. Should the lessor addressed to the lessee (president of the leasing organization), canceling the lease, will be accepted as sufficient notice by all parties herein referred to.

17. Unless canceled as herein provided, all rights granted in and by this lease shall cease and terminate on \_\_\_\_.

18. As an indication of acceptance of the stipulations and conditions herein, the "Acceptance" will be signed below and unless or until this lease is executed by the parties hereto, and the \$\_\_ as herein provided paid, the landowner is in no way obligated under the terms and conditions hereof.

SIGNED

---

Date	Lessee
------	--------

---

Date	Lessor
------	--------

Note: If the leasing organization is incorporated, the current president can sign for his members; but, if the leasing organization is an unincorporated association, all members must sign the lease.

## Appendix E. Types of Hunting Leases

The variations in lease agreements can be grouped into 4 types: (1) Day lease, (2) Season lease; (3) Year-round lease, and (4) Brokers or outfitters.

1. Day Lease—Hunting area is leased on a daily basis and usually a fixed amount per day is charged.

Advantages:

1. Generally yields higher average net return per acre.
2. Provides use for an extra labor available during the hunting season.
3. Guests can be invited without making any special arrangements with paying hunters.
4. Allow for more complete harvest of some species and provides flexibility to vary the number of game birds or animals taken.

Disadvantages:

1. Requires considerable time during the hunting season.
2. The most expensive arrangement to the landowner in terms of management cost.
3. Income is generally not known in advance.
4. Usually there is very little familiarity with individual hunters.
5. Landowner must be people-oriented.

2. Season Lease—The landowner leases out land to a certain party of hunters for the entire season.

Advantages:

1. Little management time and labor is involved.
2. Landowner knows his hunters personally.
3. System involves minimal trouble.
4. Lease expensive arrangement for the landowner; he works only with one person or group.
5. Income is known in advance.

Disadvantages:

1. On the average, this method yields the lowest net return per acre of all personal leasing arrangements.
2. There tends to be very little flexibility used in regulating wildlife populations.
3. Requires special arrangements be made for hunting by guests of landowner.

3. Year-round Lease: The landowner leases out his land to one party of hunters. It usually includes all hunting privileges, and may include other recreational privileges.

Advantages:

1. Little management is required.
2. Hunters assume all responsibility.
3. Good hunter-landowner relationships may be established.
4. Income is known.
5. Lease contracts may be for several years.

Disadvantages:

1. Game may be inadequately harvested.
2. Hunters may be on the land at undesirable times.
3. Landowner may be reluctant to increase lease price or change arrangements.

4. Broker or Outfitter—Landowner arranges with an individual to assume all responsibilities of hunting on land; this individual then leases out the land and controls hunters.

Advantages:

1. Landowner is removed from management responsibilities and is free to carry on usual activities.
2. Income is known.
3. Wildlife management can be provided by the broker.
4. Requires little or no time of the landowner.

Disadvantages:

1. Reduced income, lowest of all arrangements to the landowner.
2. Landowner does not know hunters and may not be aware of activities occurring on his land.
3. Landowner has no direct control over hunters once lease is signed.

Each situation or land acreage is different; a lease agreement has to be custom-designed to fit landowner and hunter requirements. For the first lease, it is probably best to offer a limited duration lease so as to gain experience.

### **Reference**

*Guidelines for Increasing*. Edited by F. Robert Henderson. 573 pp. 1984. Extension Service, Kansas State University, Manhattan, 66506. \$27.00

## Chapter 25

# Marketing Farm/Ranch Recreation

*Jeff Powell and Richard Olsen  
with modification by Edward Kozicky.*

### *Strategies*

There are two different strategies for marketing farm/ranch recreation opportunities: 1) selling what is available to those who want to buy what a farmer or rancher has to offer or 2) producing something not now available because of changing consumer trends.

One of the primary reasons recreational enterprises is even considered by many farmers or ranchers is consumers have decreased their demand and subsequent willingness to pay for farm/ranch products. Consumers do not want as much of what farmers or ranchers now have available. In this case, a greater effort must be made to convince consumers they do want what they have available.

Another alternative is to determine what consumers are willing to pay for that a farmer or rancher can provide and change production and management practices accordingly. However, most farmers or ranchers do not want to give up the way of life with which they are familiar, and they enjoy.

Therefore, the optimum marketing strategy for most farmers or ranchers is a unique combination of the two basic marketing strategies. By understanding what he/she has that can be successfully marketed in light of what a recreation guest(s) will pay for, a farmer or rancher can more effectively and efficiently utilize available resources and maximize net profit.

Planning is a continuous, dynamic, and repetitive process. Resources are assessed based on existing information and objectives. Consumer profile and marketing data are obtained and the objectives and resources re-assessed. Resources and facilities are then modified to better satisfy consumer desires. Marketing and promotion are then modified to more effectively attract and satisfy guests.

### *Target Audience*

Consumer profiles of the farm/ranch recreation guest have not yet been documented to a quantitative degree. Each farmer or rancher has his/her own perception of the average recreation guest based on his limited experience, but few studies have described the recreation guest(s) over a broad regional or seasonal basis.

A regional farm/ranch recreation consumer profile can be approximated by using information from state tourism commissions and from regional and national surveys of outdoor recreation consumers and tourists. State and local surveys can provide specific information for a particular area

or clientele. National trends as related to outdoor recreation are also useful.

To be a successful marketer of farm/ranch recreation, a farmer or rancher needs to learn to see himself/herself as his guests see him/her. One of the best ways to accomplish this is for a farmer or rancher to actually take a working holiday and stay as a paying guest at other farm/ranch recreation operations. By placing himself/herself in the position of a guest, he/she can begin to think like a guest and better understand what a guest wants and likes.

Seeing firsthand what other farm/ranch recreation operators offer and how they handle their guests provides a farmer or rancher a better insight into what he can also provide. A list of potential farm/ranch recreation enterprises was included in the Farm/Ranch Recreation Enterprise Checklist (Appendix A). Once a farmer or rancher decides what he has to offer that can be marketed, he/she is in a better position to decide how to evaluate the market for his/her unique service.

One real market advantage in farm/ranch recreation at this time is there are so many potential clients and so few farmers or ranchers offering the opportunity. Such a tremendous potential market often leads to disappointment and confusion because of an ineffective marketing strategy. Using the shotgun approach of trying to attract anyone and everyone is expensive and seldom effective without a massive advertising campaign. The more effective approach is to target the particular audience (e.g., sportsmen, families, retired persons, bird-watchers, photographers) interested in what the farmer or rancher has to offer.

You may want to be even more selective and try to reach specific income groups of hunters, such as doctors and lawyers, through professional journals and magazines. Fee or lease hunters tend to have higher incomes, take more hunting trips, spend more days hunting, and spend more money. If you are trying to reach bow hunters or some other specific type of hunter, advertise in the magazines published for this type of hunter.

Whereas many potential recreational activities other than hunting have been neglected, this situation seems to be changing. Largely because of the state's new or renewed interest in tourism, the number of spring, summer, and winter tourists is rapidly increasing. Therefore, if farm/ranch recreation operators are to get their "fair share" of the new tourism business, they will have to work harder and be more astute in targeting this non-hunting group of potential guests.



## *The Business Name*

Farm/ranch recreation operations, like other businesses, need to promote their product. First, businesses need attention-catching names that also describe the operation. The name is a critical selling tool because it will appear on all promotion material, stationery, and any signs for the business.

Business names are legal trademarks, and nobody else can use them. Unless owners register their names, however, they have no legal protection against others using the same name. Trademarks and names should be registered with the secretary of state.

## *Promotion*

One informs the public through promotion of a product or service, and promotion consist of three phases: advertising, publicity, and public relations. Advertising is paid notice in newspapers, magazines, signs, brochures, and other printed matter. Publicity is free notice in the media. Public relations is creating a favorable "image" and getting people to like what you have to offer. Promotion is necessary on both the local and national levels.

*Advertising.* A good brochure is the most important single promotional item of farm/ranch enterprise. It should tell the prospective guest(s) exactly what he/she can expect to find on your farm/ranch. A brochure is a salesman, product catalog, rule book, and mobile recreational show all wrapped up into one package. Advertising, publicity, and public relations all lead to just one thing—people asking for your brochure.

The copy should be light, with good photographs and art; leave plenty of space; and yet tell your story. Don't confuse the reader with a history of your farm/ranch, various membership plans, pricing structure, your biography, special events, or a rationale for your operation. Basically, a brochure is a descriptive folder that outlines the physical layout, recreational facilities, services, location, and the mail and phone contact. It should be a first-class, quality job that answers questions about your recreational operation.

Brochures can vary from a standard 8½- by 11-inch sheet of paper to a handsome full-colored booklet. It all depends on the clientele you are trying to reach and the amount of money you have to spend.

When you have developed a layout of your brochure, seek professional help. There are a number of one- and two-man advertising agencies that are eager to work with clients whose budgets are limited.

Check with your printer on paper stock, colored inks, spots of art work, size and style of type, and have a firm understanding of production costs and delivery schedule for proofs and final copy. You should seek two or more printing bids.

Price lists, fees for services, and membership plans should **not** be an integral part of a brochure. They should be printed

separately and included with the brochure when appropriate. The separate price lists and membership plans are flexible and subject to change from year to year.

Paid advertising in the media varies with various recreational activities and facilities. One cannot depend on one insertion of paid advertising. Successful advertising requires repetition. One needs to plan on a minimum of five or six ads. A single ad is a waste of money.

Once the target audience is identified, the most effective advertising campaign can be formulated. If the audience is in a particular region, advertise in that regions. Radio, TV, newspapers, brochures, letters, and personal contacts can all be used in advertising. Before starting an operation, owners need to find out the comparative costs of using these media.

Newspaper ads should be placed at least 45 days before the hunting season in newspapers with wide circulation and run as often as you can afford. For starters, you can choose a target area, such as a nearby city, and place ads only in papers serving that area. An ad for hunters should include the following:

- location and description of property
- species to be hunted
- services offered
- a statement about the quality of hunting
- who to contact by mail or phone

There are trade journals or interest group magazines for nearly every kind of group imaginable. The local librarian can help find the names and addresses of these journals and magazines. Membership lists of these groups can usually be purchased for direct mailing.

Advertising on TV or in national magazines with large circulations is usually too expensive for an individual farmer or rancher. However, a state travel commission may include licensed farm/ranch recreation operations in its advertising campaign, and the number of contacts made by a state travel commission far exceeds anything an individual operation ever dreamed possible. Many out-of-state requests for housing for travelers come to that group.

Regional or local radio and newspapers can be cost-effective, if the ads appear when potential guests are planning their vacations. January is not too early for summer visitors or for fall, out-of-state hunters.

Advertising in local newspapers and local sportsmen's organization newsletters can attract deer and waterfowl hunters, especially those wanting seasonal leases. You also should be sure to advertise in metropolitan newspapers since you want to attract urban and suburban hunters who want to "get away from it all" and are most willing to pay well for a high-quality recreational experience. Consider advertising in metropolitan newspapers in nearby states. Non-residents are willing to pay significantly more than residents for a particular outdoor or travel experience.

Both private organizations and public agencies are usually very willing to assist farmers or ranchers in advertising farm/

ranch recreation because their effort helps economic development. The local chamber of commerce, county assessor, state parks and wildlife department, and travel and recreation commissions should be contacted. These organizations should be provided brochures to mail or hand to people inquiring about local recreational opportunities. A slide show or videotape of farm/ranch attractions may be used by civic organizations and by sportsmen and trade shows.

Contacts with the local chamber of commerce are invaluable. Members may be invited to have their meetings at the facility. The name of the business can be included on any lists the chamber publishes. If managers and clerks at local motels and hotels know of the operation, they can direct guests there during peak-season overflow periods.

Sometimes editors of national magazines will feature stories on unique operations. Travel editors may be invited to visit the facilities and learn what your operation provides. They may be able to book clients. Local newspaper editors also are good sources for special stories about bed-and-breakfast enterprises. Owners also can purchase advertisement space in these publications.

One form of marketing that seems to be catching on around the country is directories of various types of outdoor recreation. Although there are few directories in existence now, ads for these directories may be found in trade organizations and in sporting magazines.

If you wish to advertise in one of these directories there are several types of information you should obtain from the publisher:

- do they operate on a state, regional, or national level?
- how many landowners (from your state or other states) are presently advertising?
- what is the charge?
- who negotiates the arrangements, fees, etc.?
- how, when, and where will the directory be distributed?
- how long has the directory been in service and how often is it updated?
- do you have the option to enroll in other directories?

Local contacts can be valuable because many of the guests will come from the community. Often their wedding and holiday guests and out-of-town relatives need a place to stay. Hospital personnel are also valuable contacts for bed and breakfast operations. Often they know of patients with out-of-town visitors who need a comfortable place to stay.

Advertisements may be posted on bulletin boards at nearby colleges and universities. Permission from college authorities is usually needed before posting. The college newspaper is another medium that can be used.

Some towns have reservation boards that list bed and breakfast establishments in the area. These boards help travelers find places to stay.

Travel agents often make referrals to various places in the community. Paying a commission to these agents for making

referrals is an inexpensive way of increasing business. The typical commission is 10 percent.

Billboards, signs on property (“To lease for hunting, call . . .”) and highway signs are worthwhile if the farm/ranch is located near a major highway.

*Publicity.* Good publicity constitutes free promotion, and it’s available if the farm/ranch operator will plan to work to obtain it. Like all good things in life, good publicity just doesn’t happen—it has to be fetched.

Some publicity leads are: Are you the first farm/ranch recreational facility in your area? Are you playing host to any celebrities? What do you feature in outdoor recreation? Are you hosting a boy scout group; a league trap, skeet or sporting clays shoot; bird-watcher group; conservation organization; fishing derby; hunting-dog field trial; archery or muzzle-loader group; etc.? Such events are double-barreled; they not only provide free advertising for your operation but create good public relations. And, the “icing on the cake” is that they can provide a source of revenue—food, refreshments, game birds, shotshells, etc.

Watch the local papers and TV stations, and listen to the radio, for the personalities who frequently handle outdoor material or tourist information. When you have thought up some story angles, take them personally to the newsroom or the studio. Introduce yourself to the receptionists and tell her who you would like to see. When you get to the outdoor columnist, sports editor, or whomever, remember that he/she is working on a deadline and doesn’t have much time to visit. Be prepared to introduce yourself and explain you visit in less than 60 seconds. Be brief and business-like.

*Public Relations.* Public relations is defined as the business of inducing the public to have understanding for and goodwill toward a person, firm, or institution. Public relations is getting people to like you and what you have to offer. It is the basis of the most powerful advertising—word-of-mouth advertising. Lots of advertising and publicity may be desirable, but nothing seems to work quite so well as satisfied customers returning and sending and bringing friends.

Your guests should be treated like royal visitors. The manager, guides, cook, field hands—everyone employed on your operation — should be courteous and helpful to the Nth degree. The guest is allowed to set the pace as much as possible. The guest should never get the impression that he/she is being rushed or on a schedule. No mention is ever made of problems that exist. The guest doesn’t really care; he/she came, most likely, to forget problems.

Sounds easy? It isn’t over a period months. As the season rolls on, the manager must maintain a constant vigil on all personnel, including himself/herself. It is well to remind yourself every morning with guests that today you are going to meet the finest people on earth—your customers.

Satisfied guests are always the most common, most effective and least expensive form of advertising. Unfortu-

nately, this takes time, so a farmer or rancher should be patient. Once you are in the recreation business, “word-of-mouth” advertising will make or break you. It’s up to you to satisfy guest(s) so they will come back and also recommend your operation to their friends.

Perhaps the best rule for the management of recreational guests is the Golden Rule. They are your customers. You spent considerable time and money just getting them to your farm or ranch. Further, both you and your guests will decide on the first visit whether to continue to do business together in the years ahead or to part company.

In the hunting preserve business, one should expect a minimum of 80 percent repeat business from one year to the next. If not, something is wrong. Your guests should leave your farm or ranch anxious to come back next year, even if you don’t plan to invite them back.

If you are offering hunting, remember that hunting is a classical exercise in personal freedom and only free men/women are permitted to hunt. So don’t greet your hunters with a long list of “don’ts.” Put any rules into a positive context. Hunters are interested in safe hunting procedures. But, give safety instructions in a positive manner. Have maps, even if they are hand-drawn, of the area in which they are to hunt.

Tell your out-of-state guests what type of clothing to bring; where they can purchase hunting licenses; help them with motel reservations if needed; and if possible with travel and eating arrangements.

Maintain contact with your guests. Write at least a semi-annual newsletter, and let your guests know what is happening on the farm or ranch. What new facilities or services have been added; what the wildlife crop is going to be; what is happening to the dogs and horses on the ranch; etc.

A farmer or rancher is in the outdoor entertainment business. If he/she stages a poor show, he will lose his customers. If he produces a good show, his/her customers will spread the word and his/her box office will be overwhelmed.

## **Pricing**

Determining the right price to charge for the farm/ranch recreation experience is difficult for a farmer or rancher with no experience in the business. Too often they underestimate what their services are worth to potential customers. Living in rural areas, they take for granted such things as the scenery and seeing wildlife. They may not recognize that besides recreation, they are selling atmosphere—farming/ranching atmosphere. A chance to hunt on a large ranch may include a camping experience, campfire visits by the rancher, hunting companions, the kill, the nightly serenade of coyotes, and, perhaps most important, freedom from life’s daily chores. In reality, the rancher is selling the total package, not just the kill.

But urbanites are eager to enjoy these pleasures and look forward to vacationing or the hunting season with great anticipation. As soon as one year’s hunting is ended, they

often start planning next year’s and may schedule their hunting vacations many months or a year in advance. Hunting or vacationing on your farm or ranch is therefore the fulfillment of someone’s year-long dream. If you fulfill it well, you can price accordingly.

At the other extreme is the farmer or rancher who attempts to pay off the mortgage with an excessive charge for poor quality service. A one-time rip-off does not build the repeat customer clientele upon which your recreational operations are dependent.

There is a wide range of rate structures among hunting enterprises, depending on location and the variety and level of services provided, such as dogs, guides, lodging, meals, ammunition, licenses, trap shooting, field dressing, decoys, camping, etc. Check around in your area.

Farmers or ranchers often require hunters to make reservations and pay a deposit several months in advance, which enables them to manage the distribution of hunters throughout the season. Hunters also may be charged an annual membership fee by their hunting club, which represents them in making the lease, paying the deposit, taking out liability insurance, and other details of arranging the hunting recreational experience on your acreage.

The cost-plus approach, similar to that used in forward-pricing contracts for livestock, requires an accurate set of business cost records. This method may be best for the farmer or rancher offering a unique recreation opportunity because there are no price comparisons available for his operation. Developing a business plan for that enterprise will help determine a fair market price and if the enterprise is economically feasible.

The sales comparison approach used by appraisers is the easiest method to use when similar recreation enterprises are available on other established farms or ranches. To be competitive a farmer or rancher must charge about the same as charged elsewhere for similar quality. They can conduct his own price comparison survey by contacting similar operations to determine the prices charged. Collecting brochures from 20 to 30 other operations may also give them good ideas as to how he/she can market his/her operation as something different from his competitors.

Because farm/ranch recreation is not standardized, it is usually worthwhile for a farmer or rancher to actually visit the other operations and decide for himself if what is advertised is what is really offered or of the same quality as that he can offer. Whereas one farmer or rancher may feel uncomfortable asking another what price he received for his calves, the farmer or rancher who caters to the general public can not afford to try to keep his prices a secret from his neighbor. Even when a neighbor does divulge the prices he charges, these prices should be weighed against industry standards and in light of all the services or fringe benefits offered.





## Appendix A. Farm/Ranch Recreation Enterprise Checklist

- |  |   |                                       |
|--|---|---------------------------------------|
| Big Game:                                    | Small Game:                                 | Furbearers:                           |
| <input type="checkbox"/> Antelope            | <input type="checkbox"/> Cottontail rabbit  | <input type="checkbox"/> Beaver       |
| <input type="checkbox"/> White-tailed deer   | <input type="checkbox"/> Tree dquirrels     | <input type="checkbox"/> Mink         |
| <input type="checkbox"/> Mule deer           |   | <input type="checkbox"/> Muskrat      |
| <input type="checkbox"/> Elk                 |   | <input type="checkbox"/> Badger       |
|  |   | <input type="checkbox"/> Bobcat       |
| Game Birds:                                  | Waterfowl:                                  | <input type="checkbox"/> Weasel       |
| <input type="checkbox"/> Turkey              | <input type="checkbox"/> Geese              | <input type="checkbox"/> Skunk        |
| <input type="checkbox"/> Northern bobwhite   | <input type="checkbox"/> Ducks              | <input type="checkbox"/> Raccoon      |
| <input type="checkbox"/> Ruffed grouse       | <input type="checkbox"/> Cranes             | <input type="checkbox"/> Red fox      |
| <input type="checkbox"/> Sharp-tailed grouse |   |                                       |
| <input type="checkbox"/> Partridge           | Other Birds:                                | Fish:                                 |
| <input type="checkbox"/> Pheasant            | <input type="checkbox"/> Big birds (eagles) | <input type="checkbox"/> Warm water   |
| <input type="checkbox"/> Mourning dove       | <input type="checkbox"/> Songbirds          | <input type="checkbox"/> Native       |
| <input type="checkbox"/> Prairie chicken     | <input type="checkbox"/> Pests (crows)      | <input type="checkbox"/> Stocked      |
|  |   | <input type="checkbox"/> Streams      |
| Others:                                      | Rodents:                                    | <input type="checkbox"/> Reservoirs   |
| <input type="checkbox"/> Coyotes             | <input type="checkbox"/> Prairie dogs       | <input type="checkbox"/> Beaver ponds |
| <input type="checkbox"/> Jackrabbit          | <input type="checkbox"/> Ground squirrels   |                                       |

### Non-Game Activities

- Shooting: predator and prairie dog; trap and skeet; archery; target
- Water: swimming; boating; tubing; skiing; fly tying; fishing clinics
- Winter: X-C skiing; snowmobiling; sledding; ice fishing
- Roadside or homebased business: food products; crafts; souvenirs
- Nature: hiking; camping; picnicing; photography; painting; bird or people watching; star gazing; posey-picking
- Lodging, meals, outfitting, bus tours
- Rocks: collecting; polishing; climbing; throwing
- Historical: archeology; arrowheads; forts; buildings
- Ranchwork: roundup; haying; fencing; feeding; calving or lambing; building log cabins; removing old barn boards for sale
- Ranch skills: horseshoeing; leatherwork; camp cooking
- Habitat improvement: brush piles; fish dams; duck blinds; bird houses
- Horses: riding; pack trips; wagon trains; stagecoach; in-town rodeos
- Games and activities: tomahawk throwing; horseshoes; volleyball; sundeck; reading; hammock sleeping; drinking; in-town festivals; dancing
- Doing nothing all day long but just sitting still

\_\_\_\_\_  
 \_\_\_\_\_



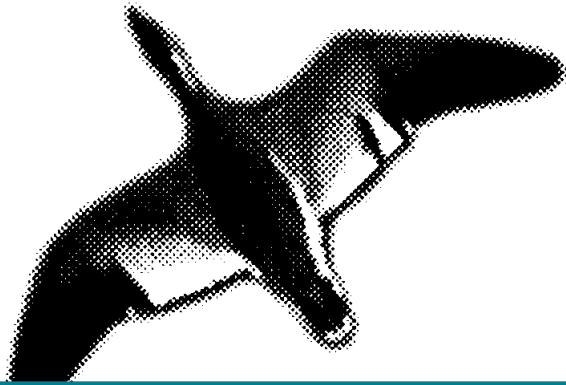

PRIVATE  
LANDS

SECTION V  
FISH

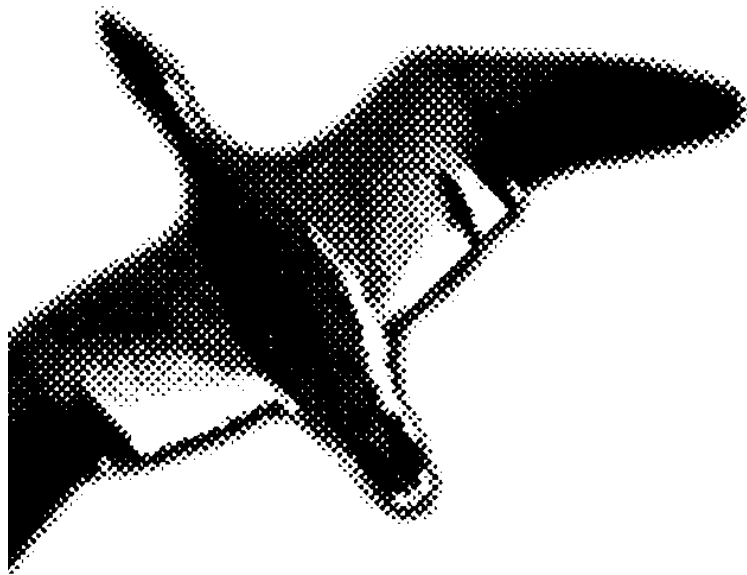

WILDLIFE  
MANAGEMENT

A Technical Manual  
&  
Correspondence  
Course



## Chapter 26

# Producing Fish and Wildlife from Kansas Ponds

*Donald Gabelhouse, Richard Hager, and Harold Klaassen*

## Introduction

Approximately 100,000 Kansas ponds offer some of the best and some of the worst fishing the state has to offer. Under good conditions, ponds are capable of producing high-quality fishing because the kinds of fish stocked in ponds interact and complement each other. The size of a pond also makes fish readily available to anglers of all ages.

Poor fishing occurs in Kansas ponds for two major reasons. First, most ponds are not built expressly for fishing. Potential fishery benefits are often unrealized because some uses such as direct watering of livestock destroy fish habitat and decrease water quality. The pond owner may be interested in fishing but unwilling to manage the pond to produce good fishing, especially if a primary use must be altered.

Poor fishing also occurs because most pond owners and anglers lack understanding of appropriate fish management practices. Fish and wildlife can be accommodated in a multi-purpose pond with minimal adverse effects on other uses. While it may be infeasible to put all of these ideas into practice, pond owners and anglers should be aware of the potentials that exist for a pond that is built, developed, and managed as outlined in this chapter. Fish and wildlife can contribute significantly to the quality of life in Kansas!

## Getting Started

Kansas Department of Wildlife and Parks (KDWP), Soil Conservation Service (SCS), and Kansas State University provide technical assistance to landowners for various conservation practices.

In addition to furnishing fish for ponds, KDWP provides advice and assistance pertaining to construction, development, and management of ponds for both fish and wildlife. They also conduct research to discover new and better ways to manage ponds for fishing. Knowledge of improved management techniques is then passed on to the public through presentations, personal contact, and publications.

KDWP also provides technical assistance to landowners desiring to improve terrestrial wildlife habitat on their property through a Wildlife Habitat Improvement Plan (WHIP). WHIP may also offer financial help to acquire seed and plant material, labor, and machinery.

The SCS provides conservation information and assistance to landowners. Help regarding location, design, construction, and maintenance of ponds can be secured from SCS offices in all Kansas counties. Pond owners may obtain cost-share funding through program administered by the Agricultural Stabilization and Conservation Service (ASCS).

The Division of Biology at Kansas State University conducts fishery research and provides advice to pond owners. The University's Cooperative Extension Service also supplies information and advice as well as trees and shrubs for planting at nominal prices. Their help can be secured by contacting any county agricultural agent or the fisheries and wildlife extension specialist at Kansas State University.

## Pond Permit Requirements

When building a new pond or refurbishing an old one, a landowner must obtain a permit if the structure will impound 30 acre-feet or more of water measuring to the top of the dam. Applications are available free of charge from the Chief Engineer, Division of Water Resources, State Board of Agriculture, 503 Kansas Avenue, 4th Floor, Topeka, Kansas 66603, from the water commissioners at Garden City, Stafford, Stockton, or the Topeka field offices, or from any county SCS or ASCS office.

The applicant is required to submit a detailed construction plan, specifications of the dam, and any other data or information the Chief Engineer may request. The Chief Engineer has the authority to accept or reject any pond application. Failure to comply with the requirements is a class "C" misdemeanor, and the court may, by mandatory injunction, require the removal or modification of any dam.

A permit is also required to construct a pond or otherwise modify habitat occupied by threatened or endangered fish and wildlife species. Such permits can be obtained from KDWP.

Cost sharing programs administered by the ASCS will not be allowed without proper permits. ASCS personnel are familiar with pond permit requirements and can help fill out applications. SCS personnel can also provide this assistance.

It is also a good idea to file for a water right on impoundments built to retain 30 acre-feet or more of water. Water appropriation rights are obtained through the Division

of Water Resources for a \$50 fee. Without a water shortage right, the pond will be subject to removal, or water releases may be necessary for water right holders downstream from the impoundment.

## ***Site Selection***

### **Watershed Size**

The size of the watershed, or the amount of area that drains into a pond, is important to the success of the pond. Without special construction considerations, damming an area that carries too much water may cause erosion problems within the pond while too little water may allow the pond to go dry. The minimum area needed in the watershed for each acre of pond surface varies from 100 acres in western Kansas to 10 acres in eastern Kansas. Central Kansas ponds usually require a ratio of approximately 25 acres of drainage to 1 acre of pond surface. The best ratio for any specific location depends on the soils, type of vegetation in the watershed, the intended uses of the pond, and drainage pattern and slope of the watershed.

### **Land Use**

Land use in the watershed above the pond should be considered when selecting a site because the quality of the fish community in the impoundment will reflect the quality of the watershed. Active erosion may fill a pond with sediment in relatively few years. Land with grass cover generally has less erosion and is desirable. Land with row crops can produce erosion and sedimentation problems if soil conservation practices are not applied and if a grass buffer area is not developed. Cropland can also contribute toxic materials, such as pesticides and excessive nutrients in the form of fertilizer, which can lead to fish kills and aquatic vegetation problems.

### **Topography**

A site with suitable topography can save money during construction and avoid problems in operation. A natural draw or low area with a moderate slope which narrows at the dam site involves less earthmoving and still provides adequate amounts of deep water. Extensive flat areas usually provide too much shallow water, which encourages the growth of aquatic vegetation and results in excessive evaporation losses. Extremely steep sides often contain too little water shallow enough for fish spawning to occur and may be unstable and slump into the pond. Major drainages should be avoided as pond sites because large amounts of runoff are difficult to retain. Damming a stream usually requires an extensive spillway and modified dam to handle the volume of flow. Streams also commonly carry high silt loads and provide access to the pond for undesirable fish species.

## ***Soils***

It is important to determine soil type at the site before construction begins. Soils in the area to be impounded must hold water with a minimum seepage. Soils for an embankment pond must also be suitable for dam and spillway construction. Clay and silty clay are good soils for impounded areas, but some clay soils stay in suspension, causing water to remain turbid. Sandy clay is generally suitable, while sand, gravel, and sand-gravel mixtures are unsuitable. Outcrops of shale, limestone, sandstone, or other bedded materials should also be avoided. These may contain crevices or channels that can cause excessive water loss or seepage from the pond. Detailed information on the suitability of various soils for pond construction is available from the SCS through the local conservation district.

## ***Pond Uses***

Intended pond uses and the question of whether to stock fish or not should be determined before a site is selected and the pond is designed. While it is sometimes best to design a pond for its primary use, multi-purpose ponds can be constructed for a variety of uses as long as all uses are considered in the design stage. While not normally compatible with fish production, even livestock can be accommodated through proper pond design.

## ***Pond Construction Considerations***

Ponds designed and constructed primarily to provide sport fishing usually provide fewer management and maintenance problems. The following construction features can make the difference between a good and an average or poor fish pond.

### ***Pond Size***

Ideal fish ponds cover from 1 to 5 acres. Without exacting harvest restrictions, ponds smaller than  $\frac{1}{4}$  acre are suitable for catfish but are usually unsatisfactory for bass and bluegill due to the potential for overharvest of bass. Ponds over 5 acres can provide angling to greater numbers of fishermen, but if problems occur, management is usually more difficult and expensive.

### ***Pond Depth***

Recommended minimum depths vary depending on the site and location. Adequate depth is necessary for continued fish survival. Ponds which are spring fed should be at least 8 feet deep over at least one-quarter of the impounded area. Ponds which have surface runoff as their primary source of water should be 15 feet deep over one-quarter of the impounded area in western Kansas and at least 10 feet deep in eastern Kansas. Not more than one-fifth of the im-

pounded area should have a water depth of less than 2 feet. Slopes along the shoreline for two-thirds of the distance from the dam to the upper end of the impounded area should be no flatter than 3 feet horizontal for every 1 foot vertical (3:1).

Deep water protects fish from winterkill and discourages excessive growth of aquatic vegetation. A pond over 15 feet deep is usually a waste of money, as extra-deep waters are rarely used by fish in the summer and do not add to the pounds of fish produced in the pond.

### ***Site Preparation***

Construction of a pond alters the environment and thus affects associated wildlife. Negative impacts on wildlife can be minimized if stabilized draws leading into and out of what will be a pond are left unchanged. Trees and other plants growing along such areas serve as wildlife habitat while detaining silt.

The dam or foundation area should always be cleared of trees, boulders, stumps, roots, sod, and rubbish. Brush and trees in the fill could lead to leakage through the dam. Brush and trees can be left for fish cover in upper end and side drain pool areas of larger ponds containing bass. More information on this subject is presented in the "Fish Attractors" section. Topsoil containing organic matter should be stockpiled for later use. After construction is complete, this topsoil should be spread over the dam and spillway to help the growth of grasses and over the basin to increase the productivity of the pond.

Small ponds should have all brush and trees removed from the pool area. This is necessary in small ponds because the majority of soil removed from the impounded area will likely be needed to construct the dam. Brush and trees need to be removed from catfish-only ponds because catfish typically overpopulate in the absence of bass predation if brush and trees are available as spawning sites.

The bottom of the pond should be left rough or irregular to create fish habitat in bass-bluegill-catfish ponds. In addition, drop-offs, islands, and trenches should be constructed in the basin when feasible. Catfish-only ponds should have a smooth bottom, again to discourage excessive spawning which could produce an overpopulation of small catfish.

### ***Potentially Leaky Ponds***

Soils in some pond sites must be sealed to prevent potential leakage. These sites should be used for a pond location only if there is no alternate site, because most methods of sealing ponds are expensive. Professional advice should be obtained before attempting to seal a potentially leaky pond. This subject is discussed further under "Sealing Leaky Ponds."

### ***Dam***

It is important that the material in the dam be tied to the soil in the foundation. A cutoff trench should run lengthwise along the dam. This cutoff or core trench should be back-filled with clay-type material compacted in layers. Failure to install a core trench may result in seepage and even loss of the dam.

The dam should be constructed of impervious moist material that is compacted in continuous horizontal layers as it is installed. Dams pushed up with a dozer and not compacted have a greater chance of failure.

The dam should be constructed with slopes that will not slump or slide. The steepness of the slope on the pond side of the dam should not exceed 3:1; and the steepness of the slope on the downstream side should not be greater than 2.5:1.

The recommended top width is 10 feet for a dam under 20 feet in height. This width should be increased an extra 2 feet for each 5 feet of dam height over 20 feet.

All dams should have extra height or freeboard to prevent floodwater and waves from topping the dam. The minimum elevation of the top of a dam should be 1 foot higher than peak flow of water in the emergency spillway or 3 feet higher than the non-flowing elevation of the emergency spillway.

### ***Spillways***

All embankment ponds require one or more spillways for overflow water. It is common to have a vegetated earthen emergency spillway around one end of the dam for flood flows and a pipe spillway through the dam for normal flows. The stand pipe or trickle tube should be installed a foot or more below the level of the earthen emergency spillway. Anti-seepage collars are needed along the pipe through the dam to help prevent the pipe from washing out. A trash guard should be installed on the stand pipe for safety purposes and to prevent clogging with debris.

The design capacity and type of materials needed for both the emergency and pipe spillways are variable for different pond sizes and watersheds. Technical advice should be obtained from the SCS or a civil or agricultural engineer for this portion of the pond design.

### ***Drain Pipes***

All fish ponds should have a drain so that the pond can be emptied if undesirable fish populations develop. The drain pipe may be a separate installation or incorporated as a valve in the stand pipe. A separate drain pipe which runs through the dam should meet loading pressures and have anti-seepage collars.

## ***Banks***

Shorelines should have 3:1 slopes to reduce the chance of aquatic vegetation problems. Slopes that are too steep (more than 2:1) can be a safety hazard for people and livestock and could slump or slide into the pond. Shaping of the banks during pond construction may cost extra but can save money in the long run by reducing aquatic vegetation problems. The dam should be protected from wave action and erosion. Rock riprap or special-purpose grasses are commonly used on dams for wave protection.

## ***Making Uses Compatible***

A fish pond may have other compatible uses if these uses are planned in advance and the appropriate features are included in design and construction.

## ***Livestock Water***

Fish ponds are a good source of livestock water if properly constructed. Ponds less than 2 acres should be fenced to exclude livestock and a pipe should be installed through the dam to a stock tank located below the dam outside the fenced area. Keeping livestock out of the pond benefits both the pond and livestock from an animal health and economic standpoint. Weight gains are greater for cattle that water out of tanks than those that drink the same water they live in. When livestock are allowed access to the pond shoreline, they trample banks, decrease the useful span of the pond, and prevent development of desirable fish communities by muddying and overenriching the water.

## ***Irrigation***

Irrigation and sport fishing are usually not compatible uses due to the large fluctuation of water levels and possibilities of summer and winter fish kills. Small gardens and lawns can be irrigated from large ponds if sufficient drainage area is available to offset water use and losses, such as leakage and evaporation.

## ***Silt and Flood Water Detention***

Ponds designed to retain silt and high volume of water normally remain turbid for long periods. Sight-feeding fish, like bass and bluegill, do poorly in such ponds. Channel catfish can be stocked successfully in ponds with muddy water as long as no spawning sites are available. Catfish overpopulation is a threat if spawning occurs.

## ***Recreation***

A pond of from 2 to 5 acres can provide many hours of fishing, swimming, non-power boating, and other recreation activities. Power boating and skiing do not normally mix well with fishing because wave action can erode the shoreline and muddy the water. Ponds over 5 acres are

sometimes suitable for public recreation on a fee basis. If the pond is to be used for recreation, safety measures are needed. All trees and other material should be removed from the marked swimming area, and lifesaving equipment, such as ring buoys and ropes, should be available. A ladder or long plank should be placed near the pond during ice skating season in case of an accident.

Ponds, like any body of water, attract people. This can lead to the possibility of an accident. The liability of the pond owner can vary depending on whether the party is an invited guest, a trespasser, or an individual who has paid fees. Many other factors can influence the pond owner's liability in case of accident. It is recommended that pond owners consult their attorneys and insurance agents for proper protection against lawsuit.

## ***Fire Protection***

A fish pond can provide water for fire fighting if it is located near a house or buildings. A pond can also be used to fill a fire truck if a proper access road is available.

## ***Maintenance***

Proper maintenance of the pond is as important as good design and construction. The pond should be checked on a regular basis for erosion, pipe damage and obstruction, and fencing. Timely maintenance usually prevents expensive repairs or possible failure of the dam. It is much easier to shape small eroded areas and keep pipes free of trash than it is to replace the dam.

## ***Area Development***

Development around the pond can influence use and maintenance of the pond itself. The dual usage of fishing and wildlife can even cause management conflicts if consideration is not given in the development stage.

## ***Fencing From Livestock***

All fish ponds with impounded areas less than 2 acres need to be completely fenced if livestock are present. Larger ponds should be fenced if physically possible. Even partial fencing of large ponds provides some benefits. The amount of fenced area required for any given pond will vary with adjacent land uses and pond owner desires. A minimum would be to set the fence back 40 to 50 feet from the pond's maximum high water level. The shoreline, dam, and spillway must be protected from livestock access. On existing ponds, with no easy means to provide water except from the pond itself, livestock access should be restricted to one or two watering points.

## Establishing Vegetation

Permanent native vegetation should be planted on the dam, spillway, terraces, waterways, and other construction areas as soon as possible. Native grasses, such as buffalograss, Indiangrass, switchgrass, and western wheatgrass, planted in combination with forbs, such as Maximilian sunflower, and legumes, such as prairie clover, provide cover for wildlife and protection from erosion. Local SCS personnel and KDWP district wildlife biologists can provide recommendations on species, seedbed preparation, fertilization, and planting times.

## Pond Basin

Planting a cover crop in the pond basin or the area to be flooded is recommended for new ponds over 5 acres. Planting rye, oats, wheat, sudan grass, or other cover crops before flooding helps tie down the bottom soil and keeps the water clear, provided the seed has sufficient time to grow prior to being covered with water. Flooded vegetation also supplies a substrate on which fish food organisms develop. Ponds less than 5 acres frequently fill too rapidly for planted vegetation to establish.

## Dam Plantings

The dam should be protected from erosion due to wave damage with either rock riprap or special grasses. A dense cover of prairie cordgrass, Kanlow switchgrass, Chinese silvergrass, or Reed canarygrass may adequately protect the dam where wave action is minimal. Trees should not be planted or allowed to grow on the dam because their roots can cause water leakage problems.

## Pond Banks

The banks and a buffer area around the pond should be planted to permanent vegetation. Native vegetation, including switchgrass and other water-tolerant grasses, should be used. This buffer strip provides wildlife habitat as well as preventing silt from entering the pond from adjacent areas. Vegetation banks also provide a pleasing setting for fishing and other pond uses.

## Wildlife Habitat

Regardless of how a pond is built or managed, fish are not the only animals that will benefit from its presence. In fact, creatures, such as frogs, salamanders, turtles, and birds, may begin using a new pond immediately, often before fish are established. While it's true we don't often go to a pond just to watch wildlife, a brood of wood ducks, or a deer coming to drink can highlight a fishing trip. What child is not fascinated watching the dervishing or whirligig beetles on the glass-smooth surface of a pond? The point is, a pond is not just a "fish" pond. It is a community of many living

things, most of which depend on each other for survival. The pond itself forms a connecting link between aquatic and terrestrial worlds. By considering the pond's influence on land animals as well as water dwellers, the pond owner can enjoy the best of both worlds.

## Fencing

When considering enhancing wildlife habitat around a pond with livestock nearby, the first thing to do is start driving fence posts. Fencing has been recommended in nearly every pond booklet and leaflet ever written. The subject has even been addressed earlier in this booklet. The same recommendation will probably be included in every booklet printed in the future. Regardless of how many times it is repeated, the fact remains that fencing is an important, if not the most important, measure needed on most ponds to protect and enhance wildlife habitat. The effects of livestock grazing and trampling around concentration areas like ponds has been well documented in many scientific and popular publications. Livestock may make a pond edge more attractive to mourning doves, but the bare mud will offer little to other wildlife.

## Planting the Pond Periphery

Planting the pond area has already been discussed to some extent from the standpoint of erosion and sediment control. However, pond owners should also be aware that vegetative cover will largely influence what types of wildlife regularly use the pond.

In native rangeland, merely fencing the grassed area around the pond will provide the low, herbaceous cover needed to benefit ground-nesting birds and mammals. If the pond is to be located in cropland or tame grass pasture, a native grass mixture should be planted within the fenced area. The SCS's specifications for range seeding and critical area planting should be followed.

Depending on the land available, tree and shrub plantings should be considered. A windbreak of trees on the south and west sides of the pond will provide cover for birds and small mammals and help reduce wave action and turbidity in the pond. A two-row planting of cottonwood or autumn olive and Rocky Mountain juniper or red cedar will usually begin to provide some wind protection within 5 to 7 years after planting.

Random clump plantings of trees and shrubs can also be incorporated if sufficient space is available. Plants which are adapted to the site conditions and have proven wildlife values should be used. Some woody plants known to be attractive to wildlife include the native dogwoods, wild plums, aromatic sumac, red cedar, autumn olive, and multiflora rose. In some parts of eastern Kansas, cedar and rose have proven to be problem invaders on grasslands, so their use in wildlife plantings may not be desirable. Other

plants can be substituted, however, and still achieve results. The pond owner is invited to contact the local office of the KDWP, SCS, or Extension Service office to obtain technical assistance in planning vegetation introductions for a specific pond site.

### **Waterfowl Management**

Ponds with permanent water will attract a variety of birds ranging from tiny shorebirds to an occasional goose. Most pond owners enjoy seeing waterfowl use their ponds, and most ponds can be enhanced to increase chances for their usage. However, the decision to manage a pond for waterfowl must be made before the pond is built. No matter which management technique is eventually used, a water control structure must be included in the dam. Nearly all successful waterfowl efforts on impoundments require some water level manipulation.

The most suitable method for attracting waterfowl during migration is to provide a flooded food source. This can be accomplished by lowering the pond's level 2 to 3 feet during late June or July. A grain crop such as millet should then be seeded on exposed mud flats just as soon as the water is removed. The water should be maintained at this lower level while the millet germinates and grows. The water level can be raised back to normal about October 1. This will create a flooded food source highly attractive to many kinds of waterfowl, especially puddle ducks like teal and mallards.

Often, conditions almost as desirable can be created simply by drawing the water down in late June or July, and allowing annual weeds and grasses to develop naturally on exposed mud flats. Reflooding should again begin about October 1. This is a simpler method and is often just as successful as sowing a grain crop.

Some potential problems must be considered before a pond is managed for waterfowl by using water-level fluctuation. Water supply often is a limiting factor in pond management for waterfowl. Unless sufficient inflow is available for reflooding, lowering water levels should not be attempted. If a pond cannot be refilled, the decreased water depth may be harmful to fish during the winter. Another problem results even if enough water is available for refilling. Decomposition of flooded vegetation may result in a rapid loss of oxygen in the water and can cause substantial fish kills. Lastly, a pond built to maximize waterfowl use would contain extensive areas of shallow water with large amounts of aquatic vegetation desired. Fish ponds, on the other hand, minimize shallow water areas so that excessive aquatic vegetation is avoided.

If land is available, a more suitable way to provide waterfowl habitat without interfering with fish management potential is to construct a 1- to 3-acre shallow-water area below the pond dam. Water from the pond can then be used

to seasonally flood the area, creating a man-made marsh. Timely drainage during May should result in a dense stand of desirable wetland plants, such as smartweed, which can be flooded in the fall. Shallow-water areas can also be drained in late June or July and seeded to millet if the pond owner desires. Such shallow-water areas offer many more wildlife options than trying to rely on water-level manipulation within the pond itself. The pond-marsh combination provides for much more efficient use of water since only a 12- to 15-inch average depth is needed in the marsh. To further enhance such shallow-water areas, openings should be mowed in dense, tall vegetation before flooding. A good rule of thumb is to provide a marsh habitat with half open water and half emergent vegetation. KDWP district wildlife biologists and SCS personnel can provide further information regarding construction of and cost-share funding for marshes.

### **Habitat Maintenance**

All too often it is assumed that, when wildlife habitat is established, the job is done. Since vegetation is the major component of habitat, the habitat is always changing due to plant succession. Consider an abandoned cropfield. For the first several years, it is mostly annual grasses and weeds. Gradually, it grows into perennial grasses and weeds. Over the eastern third of the state, such areas will eventually become dominated by brush and trees.

The secret of encouraging wildlife utilization of a habitat is to maintain a stage of succession which will benefit the kinds of wildlife desired. Since it is impossible to hold vegetation in just one stage for any great length of time, it becomes necessary to set back succession and allow the process to occur again, thus recycling the most beneficial successional stages.

Succession is more rapid in eastern Kansas and slows down in the more arid regions of western Kansas. Nevertheless, it still occurs statewide and must be considered in a maintenance program. Limited or controlled burning, mowing, plowing, discing, and grazing all can be valuable habitat maintenance tools. Even chemicals, with careful use, can be of value. KDWP district wildlife biologists can be of assistance in recommending and explaining habitat maintenance procedures.

### **Fish Attractors**

Trees and brush which must be removed to obtain fill for the dam should not be burned. A beneficial use is to relocate this material within the pond basin to serve as fish attractors. Fish attractors are designed to produce food and provide cover for fish in the pond. Their ultimate purpose is to concentrate fish for angling.

Fish attractors in the pond can benefit all species of fish. Bluegills, minnows, and any other prey use fish

attractors as a place to hide from predators. While hiding there, they generally find an increased food supply of aquatic insects. Bass will find an attractor a good place to feed on bluegills or to rest.

Any type of tree will work as a habitat structure. Hardwoods, such as osage orange or oak, are excellent choices, and the abundant red cedar is ideal. These trees can be tied together in any number of configurations or placed separately with pre-formed or custom-made concrete blocks as anchors. A tree is best secured to an anchor with heavy gauge wire which has been passed through a hole drilled in the tree's trunk.

Other good materials for fish attractors include tires, piles of old or broken concrete blocks, and piles of old clay tiles or pipes. Tires can be wired or bolted together in any design that suits the pond owner. A group of tires generally works better than single tire units. Several holes should be drilled in each tire to allow air to escape so the tire will sink easily.

The best attractor locations in a pond are near natural gathering places for fish or in areas where fish are to be attracted for angling. Attractors congregate fish in a particular area but don't necessarily attract fish from great distances. Therefore, logical locations for habitat attractors would be off points, at the edges of creek channels, in the mouths of caves, and near boat docks and fishing piers.

Brushpiles can be constructed in any water depth and may protrude from the shoreline into deep water. Tires, blocks, and sewer tiles are generally unsightly if exposed above the surface, so these will need to be placed in water deep enough to cover them. There is no particular depth that is most conducive to concentrating fish, so the depth of structures can be varied. Shoreline attractors can be made by cutting two-thirds of the way through a tree and felling it into the water, leaving it attached to the stump.

Fishing brushpiles is a challenge. Skill is needed to avoid the loss of lures and bait. The angler should fish straight down or near the edges of the brushpile. Bluegills and bass will move out of brush to feed if they are hungry. If the brushpile is holding catfish, the angler may have to get his bait fairly close. Strong line may be necessary to pull a good-sized bass or channel catfish away from the protection of the cover provided by an attractor.

No type of fish attractor should be placed in catfish-only ponds. Any type of structure may provide catfish a nesting site. If catfish spawn in the absence of bass, overpopulation of small catfish is likely.

### **Pond and Fish Ecology**

A basic understanding of the biology of fishes and their interactions with their environment is helpful in understanding how to manage fish. Knowledge is useful in all aspects of pond management from initial pond construction to salvaging a problem pond.

The basic needs of fishes are (1) food; (2) good quality water; (3) shelter; and (4) a spawning area. The first two items are generally the most critical, but all are important to varying degrees at some time. Each of these items will be briefly discussed to give the reader a basic understanding of the reasons for management recommendations contained in this booklet.

### ***Fish Food***

The natural foods of fishes are either produced in the pond or are washed or fall into the pond from the surrounding area. Food produced in the pond has its origin in the nutrients that are dissolved in the water and in the pond bottom. A variety of plants utilize these nutrients to grow. These plants may be microscopic algae that give a green color to the water, or they may be large-rooted plants that grow in shallow water areas. Plant material in turn is food for a variety of small animals, such as insects and microscopic zooplankton. These small animals are eaten by fish, such as bluegills and young bass. Large fish like bass will feed mainly on small fish, crayfish, and tadpoles. The chain of events leading to the production of large fish can follow different routes. It can follow a "food chain" from nutrients, to algae, to zooplankton, to small fish, to large fish, or it can go from nutrients, to rooted plants, to insects, to small fish, to large fish. In reality, food chains have more links or steps than mentioned here, and there is considerable crossing over between the various chains. What really exists is a "food web."

All ponds contain nutrients which ultimately produce food for fish. The amount of nutrients present depends upon the productivity of the watershed. The amount of fish that the pond can support is called the "carrying capacity." This is comparable to a pasture's capacity to support only a certain amount of livestock. In Kansas, mixed species ponds typically support between 100 and 400 pounds of fish per acre if supplemental feeding is not provided. The average pond supports about 250 pounds of fish per acre. Populations can comprise many small individuals or fewer large individuals, but the total weight of fish will depend upon what the pond can support. The amount of fish food a pond will produce is limited by the amount of nutrients and will be shared by the existing fish community. By managing for fewer fish, larger fish can be produced.

### ***Water Quality***

Fish require good quality water to survive, grow, and reproduce. Good quality water is free of pollutants, such as toxic materials, excessive organic matter, and silt. Water should also have a high oxygen content. Oxygen deficiency is a common water quality problem encountered in ponds. Most fish species require at least 5 parts per million (ppm) of dissolved oxygen for good health and vigorous growth.

They can tolerate 1 or 2 ppm for short periods, but they will become stressed, will cease feeding, and may become susceptible to diseases.

The amount of oxygen contained in the pond depends upon the water temperature and the depth. During the late winter and early spring, the water in the pond will have the same temperature from top to bottom. In late spring, increased atmospheric temperatures begin warming the pond from the surface down. Water in shallow ponds located in open areas readily exposed to the wind may continue to mix throughout ice-free periods, but by the summer, the surface water in deeper, less windswept ponds is considerably warmer (and much lighter) than the bottom water, so a thermal stratification occurs. This is a fairly stable condition with the warm upper layer (epilimnion) floating on the cool bottom layer (hypolimnion), separated by the transition zone (thermocline). As the wind blows, only the upper layer is mixed and oxygenated. The lower layer does not receive additional oxygen and, in fact, slowly loses its oxygen by the decay of organic matter on the bottom. By mid-summer oxygen is consumed in the lower layer so fish are confined to the upper layer and thermocline. This is why ponds built deeper than 15 feet waste space during the summer. On the other hand, a pond that is too shallow (less than 10 feet) may encounter summer-kill problems. This topic is discussed further in the "Fish Kills" section.

In late summer and fall, the surface water cools until its density is similar to the bottom water. Strong winds are then able to mix the water from top to bottom. This carries oxygenated water to the bottom, and fish are again able to inhabit the entire pond.

After ice forms in the winter, water on the bottom of the pond is slightly warmer than water just under the ice. Fish usually prefer to locate near the bottom for this reason. Since ice prevents a mixing action from occurring, organic wastes again settle to the bottom, much as occurs during the summer. Decomposition of organic wastes uses oxygen, and excessive decomposition can drive fish off the bottom, up the water column, in search of oxygen. Severe cases of decomposition in combinations with lack of oxygen production by plants results in an oxygen deficiency throughout the pond and eventually winterkill. Particulars on this subject are discussed in the "Fish Kills" section.

### ***Shelter***

Fish are eaten by a great variety of mammals, birds, reptiles, amphibians, other fish, and even invertebrates (some insects eat small fish). In order to survive, fish have evolved various behavior patterns. Pond fish always try to hide when danger threatens. They can hide by swimming to deeper water or by moving behind a rock, stump, brush, or plant. In a pond, fish communities will exist without

physical structure, but fish are sure to concentrate near a structure if it is present. In fishing ponds, structures benefit fishers more than the fish since anglers know the most productive areas for angling are near areas with habitat structure. This is why the addition of fish attractors is recommended in all but catfish-only ponds.

### ***Spawning Area***

Some species of fish require specific bottom material to reproduce. Largemouth bass and bluegill are generalists and will spawn on about any type of bottom material, but the channel catfish is more particular. It requires some type of cavity such as a hole in the bank or solid structure in the form of a stump or rock for nest establishment. As stated several times previously, catfish reproduction is not desired in catfish-only ponds, so nesting structures should not be provided.

When species other than bass, bluegill, and catfish are desired in a pond, it is necessary to know their reproductive requirements in order to determine whether they will be able to maintain a population.

### ***Common Pond Fish***

Many fish species can be found in Kansas ponds, but only a few lend themselves to effective management for sport fishing purposes. The most common species stocked in ponds are the largemouth bass, bluegill, and channel catfish. Other species that can be used for specific management objectives include fathead minnows, crappie, black bullhead, redear sunfish, and gizzard shad. Green sunfish and carp are also often found in ponds. A brief description of these species' life histories and some information on additional species follows.

### ***Largemouth Bass***

The largemouth bass is a large predatory fish that belongs to the sunfish family. It is one of three kinds of black bass found in Kansas, the others being the smallmouth and spotted or Kentucky bass. The largemouth is greenish colored on the back with a white belly and a dark band along its side. Its mouth is large with the upper jaw extending beyond the eye when the mouth is closed. This feature and coloration set the largemouth apart from the other two basses. This fish will eat anything it can get into its mouth. Common food items include insects, crayfish, frogs, and small fish. In the southern United States, largemouth bass commonly attain weights of over 10 pounds, but anything over 7 pounds is considered a trophy in Kansas. Largemouth will spawn after reaching a size of about 10 inches. This usually occurs during spring when water temperatures reach 60° to 70°F. The male makes a large saucer-shaped nest on the bottom in shallow water by fanning an area free of



debris with his tail. The female deposits eggs in the nest, and the male fertilizes them. The male protects the eggs as best he can from predation and maintains good water quality by fanning with his tail. If the male bass is removed, the eggs will die. He guards the eggs until they hatch and the young are large enough to swim and find food. This takes about one to two weeks.

### ***Bluegill***

The bluegill is a deep-bodied sunfish with a small mouth. With an increase in size, the fish changes from silver lavender color to greenish brown, with an orange or yellow breast. All sizes of bluegills possess a blue-black gill cover flap. Bluegills feed primarily on insects. Bluegills typically mature at a length of 3 to 5 inches. They should reach a length of 6 to 8 inches, but larger fish can be produced if properly managed. Fingerling bluegills stocked in the fall will spawn the next summer. Bluegills spawn from May to the beginning of September with a peak in June. The male makes a saucer-shaped nest on the bottom in shallow water like the bass and guards the eggs and young. The bluegill's ability to spawn so prolifically makes it a good food fish for bass.

### ***Channel Catfish***

The channel catfish is a native stream fish with a deeply forked tail, gray back, white belly, and eight barbels around the mouth. Young fish have some black spots, but these are lost with maturity. The channel catfish's diet consists mainly of invertebrates and small fish. Channels grow rapidly if enough food is available and often exceed 5 pounds. They spawn in early summer when the water temperature reaches 70°-75°F. The male makes a nest in a hole in the bank, under a log, or next to any material that will provide protection for the young. The male also guards the eggs and young fish. Male channel catfish develop a bluish color which often causes them to be mis-identified as blue catfish. The anal fin of a blue catfish has 30 or more rays while channel catfish have 24 to 29 rays.

### ***Fathead Minnow***

The fathead minnow is a common bait fish and is also stocked in ponds to accelerate initial bass growth rates. It is a dull silvery color and reaches a length of 2 to 3 inches. Fatheads feed on small invertebrates and plant material and are hardy and prolific spawners. Spawning occurs all summer. Eggs are deposited on rocks or other objects.

### ***Gizzard Shad***

The gizzard shad is a member of the herring family. It is silvery colored and has a sharp, saw-like ridge on its belly. It is the primary food for large predatory fishes in large

reservoirs. It feeds on microscopic plants and animals and can produce high numbers of young. Shad spawn from spring to summer by randomly scattering eggs in shallow water.

### ***Crappie***

There are two kinds of crappie, the black and the white. The black crappie prefers clear water and has seven to eight dorsal spines and black spots scattered randomly over its body. The white crappie is slimmer than the black, has five or six dorsal spines, and its spots tend to form vertical bars on its sides. In turbid water, white crappie usually predominate. Both kinds feed on invertebrates and small fish. Their reproduction is similar to that of the bass and bluegill. The minimum length at maturity is 6 to 7 inches. They tend to overpopulate if there is not enough predation on the young. In combination with other numbers of bass, they grow rapidly and often reach lengths of 10 to 12 inches.

### ***Green Sunfish***

The green sunfish is often incorrectly called a perch. It is a member of the sunfish family along with the black basses, bluegill, and crappie. It is greenish in color and has a medium-sized mouth. It feeds on a variety of small animals and seldom grows over 6 to 7 inches in length. Green sunfish are common in small streams and often get into ponds by swimming over spillways. They can be a nuisance in a pond if bass are not abundant. Green sunfish reproduction is similar to that of bass and bluegill.

### ***Redear Sunfish***

The redear or "shellcracker" sunfish is a native of the southern United States. It has been stocked in place of or in combination with bluegills because it grows larger than the bluegill and does not have a high reproductive potential. Redear do not typically overpopulate like other sunfish and, in fact, do not provide enough prey for largemouth bass. A redear sunfish-smallmouth bass experimental combination has met with some success because smallmouth require fewer fish in their diet than do largemouth. Problems have, however, occurred because largemouth bass commonly gain access to such ponds, out-competing smallmouth for food and space. Once a largemouth bass population develops, bluegills then need to be stocked to provide sufficient prey. Use of redear as only a sport fish in combination with largemouth bass works well as long as bluegills are also present to serve as the primary prey. A mixed stocking of two-thirds bluegills and one-third redear can add variety to a pond. Redear feed primarily on bottom organisms, particularly snails, and require clear, deep water with abundant aquatic vegetation. Their commercial availability in Kansas is limited.

## ***Hybrid Sunfish***

The three sunfishes previously described, along with some others, have all been hybridized with each other in an effort to produce offspring that do not overpopulate, grow larger than either parental species, and are easy to catch. Hybrid sunfish fill these requirements, but parental species (consisting of only males of one species and only females of the other) need to be stocked about every 4 to 5 years to maintain hybrid population numbers. Hybrid sunfish also provide too little prey to support desirable largemouth bass populations.

## ***Black Bullhead***

This bullhead is a common catfish of small, sluggish streams. Its back is gray or black, and its belly is yellow or white. The tail is not forked but slightly indented. It feeds on a variety of small animals and seldom gets over 15 inches long. Bullheads often gain access to a pond by swimming over the spillway. This species quickly becomes overpopulated if the pond is muddy or low on bass numbers. Reproduction is similar to that of the channel catfish. After hatching, young bullheads will travel in a compact school accompanied by one or more adults.

## ***Carp***

The carp is a large member of the minnow family. It feeds on bottom organisms and tends to stir up the mud and is thus undesirable in ponds if sight feeding fish are desired. Carp usually get into ponds when they are seined from creeks for bait and released or lost in the impoundment. A well-established bass population will control this species, but overpopulation problems can result if the pond is already muddy or few bass are present.

## ***Other Species***

Northern pike, walleye, flathead catfish, and trout are desired by some pond owners. While they do not cause problems in ponds, they are not particularly well suited to the pond environment. They do not reproduce adequately in ponds to maintain their own numbers; they are costly to stock, difficult to obtain, and a pond cannot support many of them. Northern pike and walleye may be part of the stocking combination in large watershed structures as long as the owner realizes that he will probably need to supplementally stock them every few years if he wants to maintain them in his impoundment. Walleye should not be stocked where bluegills are the only prey fish. Gizzard shad should be present if walleye are desired. The flathead catfish is often stocked into ponds as a trophy or predator fish. While the flathead eats primarily fish, it will not control bluegills as well as a properly managed largemouth bass population. Flatheads should, therefore, not be stocked in place of bass.

Few Kansas ponds are capable of supporting trout year-round. Trout require water temperatures below 70°F along with a high oxygen content. These conditions do not occur simultaneously in most Kansas ponds during summer months.

## ***Stocking***

### **What to Stock Initially**

A standard initial stocking of largemouth bass, bluegills, and channel catfish is recommended for all ponds one-half acre or larger with underwater visibility of at least 12 inches. Additional fish species may be added later depending upon management objectives.

It is critical that correct numbers of each kind of fish be stocked. Improper stocking may prevent a pond from ever producing a quality fishery. The pond owner should stock 100 bass, 500 bluegills, and 100 channel catfish fingerlings per acre. These fish will usually not be fishable for two years. If larger fish are stocked, numbers should be reduced. Stocking 50 8- to 12-inch bass; 250 4- to 5-inch bluegills; and 50 8- to 12-inch channel catfish per acre gives a pond a one- to two-year head start and minimizes mortality if an existing wild fish population is present.

Catfish alone should be stocked in ponds less than one-half acre or in ponds with underwater visibility less than 12 inches. If only catfish are stocked, the number is dependent upon the turbidity. In clear ponds, 200 fingerlings or 100 larger fish can be supported per acre. In turbid ponds, half this number should be stocked.

To accelerate initial bass growth rates, it is recommended that 3 pounds of fathead minnows be stocked per acre as soon as the basin contains water. It should, however, be realized that fatheads will only sustain bass for a year or two, so bluegills need to be stocked as well.

Some pond owners are reluctant to stock their ponds with bluegills because of the fish's tendency to overpopulate. Bluegills are, however, needed to provide food for bass. Without them, a good quality bass population will not develop. Bluegills are also fine sport fish if bass are able to contain their population numbers through predation so that survivors grow to desirable sizes.

Many pond owners and anglers think that 500 small or 250 intermediate-size bluegills are more than needed. They feel that by stocking fewer bluegills, the fish would be less likely to overpopulate. Just the opposite is true! Bluegill overpopulation usually occurs not because too many bluegills are stocked but because too few are stocked. If too few bluegills are stocked, an unusually high number of their first spawn will survive. The high survival is a result of little competition for available space. The problem is further intensified if bass are overharvested during the first season of fishing, leaving the young bluegills with no control, or if the pond is too muddy for bass to see to feed, or too vegetated for bluegills to be available to bass. Stocking 500

small or 250 intermediate-size bluegills per acre also produces good bluegill fishing sooner and more reliably than stocking lower densities will.

Channel catfish in moderate numbers do not compete significantly with bass or bluegills for food or space. They can be considered a “bonus fish” in that they are not an important part of the predator-prey relationship. Bass and bluegills can function just as well with or without channel catfish present. By using all three species, the pond’s potential to produce fish is more fully utilized. If properly managed, bass and bluegills need to be stocked only once. Channel catfish will have to be restocked periodically since bass will eat almost all young channel catfish that are spawned.

### ***Sources of Fish***

A combination of fingerling largemouth bass, bluegills, and channel catfish or catfish alone can be obtained from the KDWP or from commercial fish growers.

To receive catfish alone or bluegills and catfish in the fall and bass the following spring from the KDWP, the pond owner must submit an application and an aerial photograph of the pond (available from the county ASCS office) to the Pratt KDWP headquarters by July 1. Applications can be obtained from any KDWP or Soil Conservation office. If information received is complete and indicates the minimum requirements are met, a KDWP representative will inspect the pond. The pond must cover at least one acre and contain some water at least 10 feet deep. Existing fish or salamander populations cannot be present and water quality must be sufficient to sustain fish life. The pond owner will be notified when the inspection will be made.

In exchange for receiving fish from the KDWP, the pond owner agrees that for a period of 10 years: (1) to provide the public access with permission; (2) fishing laws and regulations of the KDWP will be observed at the pond; and (3) wildlife conservation officers will have free ingress to the pond for law enforcement purposes.

Pond owners can also purchase fish from commercial fish growers if they want to stock bigger fish or are not satisfied with KDWP restrictions. Purchased fish are considered to be the pond owner’s livestock. Such ponds are free of any restrictions, including license requirements and harvest methods. A list of commercial fish growers can be obtained from any KDWP, SCS, or Extension Service office. A pond can be stocked with fish legally caught elsewhere, but this practice is not advised because it is usually difficult to obtain adequate numbers, especially for large ponds, and wild fish are more likely to have disease problems than those raised by a commercial fish grower.

### ***When and How to Stock***

Chlorinated water should not be used to transport fish because it will kill them! Water taken directly from the pond

is best. It should be obtained just before picking up fish. Water collected the day before may cool significantly during the night, causing fish to die when transferred from the delivery truck into the container.

Before fish are stocked into a pond, the temperature of the water the fish are being transported in should be equalized to the temperature of the pond. A sudden change in water temperature will cause the fish to go into shock and will often result in death. Half the water in the container used to transport fish should be poured out and replaced with water from the pond. The fish should then be given five to ten minutes to adjust to the temperature change. This procedure should be repeated until the water temperature in the container is within 3°F of that in the pond. The fish can then be released into the pond without going into shock.

New or renovated ponds are commonly stocked with fingerlings (1½- to 4-inch) fish. Since these fish are small, there should be no salamanders or other fish (besides fathead minnows) in the pond before stocking. If fish or salamanders are present, the stocked fish will be quickly consumed or will be unable to compete for food. To prevent wild fish from becoming established, a pond should be stocked as soon after it fills as possible. It is, however, best to avoid stocking in summer months because high temperatures and low oxygen content in the water weaken fish being transported.

### ***Fish Management***

Proper pond construction, development, and fish stocking will not guarantee sustained good fishing. A correct start must be followed by periodic management. Some of the techniques described in this and the following section seek to affect fish populations directly, while others modify habitat within the pond, affecting fish indirectly.

### ***Regulating Fish Harvest***

Improper harvest of fish ruins future fishing in more potentially good Kansas ponds than any other cause. Pond owners and other anglers are anxious to fish a newly stocked pond, and they frequently overharvest the bass population in the first season of fishing. This allows bluegills to overpopulate the pond.

A pond owner can reduce the likelihood of bass overharvest from occurring by not letting anyone fish the pond. This practice is not encouraged, however, because underfishing as well as overfishing can lead to problems. Pond owners are urged to let others fish their ponds as long as the pond owners’ rules are followed. The pond owner who stocks KDWP fish into his/her pond should realize those fish were paid for by hunting and fishing license buyers.

One way to prevent bass overharvest is to release all bass less than 15 inches long for a period of four years from

stocking even though bass may be large enough to catch after one or two years. This means that few bass can be harvested for four years from the time of stocking unless adult fish were introduced. If 8-inch bass were stocked, the 15-inch minimum length limit would be needed for only three years (two years if 12-inch bass were stocked).

After four years from stocking (two to three years if adult bass were stocked) a management decision must be made. The choice made will depend upon what numbers, sizes, and kinds of fish are desired. Are good-sized fish of several species preferred, or is catching large individuals of fewer species more important? Often, quantity has to be sacrificed to achieve greater size.

Five management options are presented here: (1) The "All-Purpose Option;" (2) the "Panfish Option;" (3) the "Big Bass Option;" (4) the "Harvest Quota Option;" and (5) The "Catfish-Only Option." The first four options differ from one another in the ways angler harvest of bass is used to manipulate fish populations.

Bass will probably have spawned three times during the four-year period after fingerlings were stocked or three times in three years if 8-inch bass were stocked. If 12-inch bass were stocked, new year classes would have been produced in both years after the original stock were introduced. Young bass produced can come to exist in surplus numbers. If unharvested, poor growth rates occur due to excessive competition. The result will be a bass population comprised primarily of individuals less than 15 inches long.

The guidelines for each of the management options include stocking recommendations for additional fish species. Expected results from a pond not managed according to one of the options are also discussed.

### ***The "All-Purpose Option"***

This option affords the opportunity to catch fish of a variety of sizes. To catch bass over 15 inches long with any consistency, numbers of 8- to 12-inch bass must be reduced. In a pond of average fertility, about 30, 8- to 12-inch bass should be harvested per acre per year after the fourth year from stocking (second and third year if adult bass were stocked). The removal of these small bass reduces competition and makes it possible for some fish to attain lengths over 15 inches.

To ensure that at least 10 percent of the catchable-size bass survive to lengths of 15 inches and longer, all 12- to 15-inch bass that are caught should be released. A good supply of 12- to 15-inch bass will also reduce densities of intermediate-size bluegills so that some individuals grow to sizes of interest to anglers. This management option will produce bluegills of several sizes, with some reaching 8 inches.

Bluegills and catfish can be harvested as desired. Catfish that are harvested must be replaced with 8-inch or

longer individuals to maintain a sizeable catfish fishery. Without periodic supplemental stocking, few catfish will be caught because few young catfish will survive bass predation.

Northern pike can be stocked in large lakes as an additional sport fish and predator as long as the pond owner realizes the fish's limitations described previously. Rapid northern pike growth rates in Kansas present a threat to survival of original stock bass if pike are stocked too soon. Fingerling pike (6 to 10 inches) can be stocked at a density of 10 per acre two or more years after fingerling bass have been introduced or one year after adult bass. If pike are stocked sooner than this, they may prey on original stock bass, thus preventing a good bass population from developing. Walleye should not be stocked in an impoundment managed according to the "All-Purpose Option" because bluegills do not provide sufficient prey for walleye.

### ***The "Panfish Option"***

If catching big panfish is more important than harvesting bass and catching big bass, the pond owner and anglers should continue to release all bass less than 15 inches long past the initial two-, three-, or four-year period after stocking. Bass over 15 inches long can be harvested, but few fish will grow to such a size if the 15-inch length limit is maintained. High densities of 8- to 15-inch bass are more effective in controlling bluegills and other panfish than moderate numbers of bass of several sizes. By purposefully overpopulating bass, the "Panfish Option" will produce more 8-inch and longer bluegills. It is important to note that the "Panfish Option" should be followed only if the pond's water has an underwater visibility of greater than 18 inches. Bluegill and other panfish will overpopulate if bass cannot see well enough to feed on them.

A variation of this management option might well include crappie and/or bullheads in the stocking combination along with largemouth bass, bluegills, channel catfish, and fathead minnows.

Crappie and bullheads are not usually recommended for ponds because both fish have a tendency to overpopulate if bass numbers are low or if the pond is muddy and bass cannot see to feed. Problems with crappie and bullheads as well as green sunfish and carp can usually be avoided if a good bass population has developed prior to their gaining access to the pond and if the pond's water remains clear (an underwater visibility of at least 18 inches).

Twenty adult crappie and/or 20 adult bullheads can be stocked per acre two or more years after fingerling bass have been introduced. If adult bass were stocked, crappie and/or bullheads can be stocked one or more years later. The time lag between stocking bass and crappie and/or bullheads is necessary to allow original-stock bass to attain a size that can prey upon the first crappie and/or bullhead spawns. Heavy predation on young panfish will result in rapid growth by survivors because more food will be available per individual.

Black crappie should be stocked instead of white crappie because black do better than whites in clear water, and this option is recommended only when visibility exceeds 18 inches.

After adult crappie and bullheads spawn, it will take about three years for their offspring to attain lengths of 10 inches or longer.

With crappie and bullheads present, it will be necessary to release nearly all bass that are caught so that crappie and bullhead numbers can be kept under control through bass predation. The quality of bass fishing will be sacrificed to produce good crappie, bullhead, and bluegill fishing because bass must be allowed to overpopulate. Few, if any, bass over 15 inches long would exist in a pond managed in this fashion. No harvest restrictions are needed on any species but bass. Northern pike stocked as described in the "All-Purpose Option" might be used to provide additional predation on panfish.

### **The "Big Bass Option"**

To consistently produce bass longer than 18 inches without regard for the size of bluegills, anglers should again release all bass under 15 inches for four years after stocking (two to three years if adult bass were stocked) just as described for the "All-Purpose Option" and the "Panfish Option." In addition, no bass over 15 inches should be harvested during this period. After that time, densities of 8- to 15-inch bass should be reduced even more than described for the "All-Purpose Option" to allow for rapid growth by survivors. In a pond of average fertility, anglers should harvest 30 8- to 12-inch bass per acre per year as well as about five 12- to 15-inch bass per acre per year. Bass over 15 inches should continue to be released unless a trophy is caught. The odds of a 9-pound bass living another year may not be good, but fish that beat the odds are those that set records.

Twenty adult gizzard shad should be stocked per acre two years after fingerling bass have been introduced. Shad may be stocked 1 year after the bass if adult bass were stocked. With adult gizzard shad stocked into the pond, the likelihood of producing a trophy bass is greatly enhanced. Bluegills will serve as the primary prey for small bass, and shad will be eaten by large bass.

This alternative to the basic bass-bluegill-catfish combination is relatively unevaluated, but gizzard shad along with bluegills should produce bigger bass than bluegills alone. With bass eating both kinds of prey, it should be remembered that few bluegills over 6 inches will be present because survival of small bluegills will be higher than would occur without shad. The practicability of this management option may be limited to larger ponds because no more than about 10 bass 3 pounds and larger can be maintained per acre of water.

Since the bluegill population in a pond managed in this fashion will comprise high numbers of small individuals, such a pond might serve to satisfy adult anglers seeking big bass and children trying to catch high numbers of fish with no concern for size. Channel catfish stocking is not required for this management option and harvest of both catfish and bluegills is unrestricted. Periodic supplemental catfish stocking will be required to maintain a population with bass present.

In large impoundments managed according to the "Big Bass Option," fingerling walleye can be stocked 1 year after fingerling bass at a density of 100 per acre. If adult bass are stocked, walleye fingerlings can be stocked simultaneously with bass. Fingerling walleye should be stocked in the middle of the impoundment to avoid shoreline bass predation. It should be realized that by stocking walleye, fewer big bass are likely to be produced because gizzard shad that might have fed only bass will have to support both bass and walleye.

### **The "Harvest Quota Option"**

In the past, ponds have frequently been managed by allowing only a given weight or number of bass to be harvested annually. After the desired bass harvest is achieved, angling must consist entirely of catch and release regardless of the sizes of bass caught. This may occur after one or two trips in small ponds.

For the first four years after stocking (two to three years if 8- to 12-inch bass were stocked), little or no bass harvest should occur. After that time, about 20 individuals or 20 pounds of bass can be harvested per acre annually without regard for length.

The potential for bass overharvest is present with this option if the pond owner does not have complete control of fishing access and does not maintain excellent records. Even under good management, this option may not produce bass populations as desirable as those that are managed by the "All-Purpose Option" because the potential for overharvest of large bass and underharvest of small bass exists.

Channel catfish harvest is unrestricted, but catfish removed should be replaced with 8-inch or larger individuals. There is no harvest limit for bluegills using the "Harvest Quota Option." Historically, pond fish management booklets have suggested that a harvest of from 3 to 10 pounds of bluegills for every pound of bass taken would keep the pond's fish community in "balance." While anglers can afford to harvest as many bluegills as desired, such a practice without additional bass harvest restriction will not effectively keep a fish community in good condition.

This option is difficult to manage successfully. It is generally best suited for fee fishing recreation areas and children's fishing ponds.

### **The “Catfish-Only Option”**

The channel catfish is one of the most popular fish in Kansas. In fact, many pond owners want to stock it alone. This is advisable in muddy ponds where sight feeding fish like bass and bluegills would do poorly or in ponds under one-half acre where bass overharvest would likely occur. In large, clear ponds, stocking catfish alone is a waste of space because a pond will produce about the same weight of catfish even if it contains bass and bluegills. The pond owner might just as well take advantage of the angling benefits of all three species.

For a muddy pond or a pond that is smaller than one-half acre, channel catfish-only is the recommended option. The pond should be free of any structure which would provide seclusion for spawning, such as sewer tiles, stumps, large rocks, tires, or cream cans. Ponds which contain only catfish are often characterized by excessive numbers of small catfish, when suitable spawning sites exist. If reproduction can be avoided, replacement fish will have to be stocked periodically to maintain the population. Fathead minnows can also be stocked to provide additional food for catfish and a ready source of bait for the pond owner.

This option is the easiest of the 5 options to manage as long as natural reproduction does not occur. Harvest can begin as soon as fish reach a size considered to be harvestable, and no restrictions need exist on the number harvested. As catfish numbers decrease, fishing success will decline, so supplemental stocking will be required to maintain catfish at the density of 100-200 fish per acre (200 or more per acre with supplemental feeding). Catfish at least 8 inches long should be stocked each fall or spring when the water is cool. The number stocked should equal the number harvested in the previous angling season along with an additional 10 percent to replace those fish lost to natural mortality.

Catfish production in small or muddy ponds is usually quite low. If the yield of catfish is inadequate, the owner may want to consider a feeding program described later in this booklet.

### **Consequences of Unrestricted Harvest**

Some pond owners do not care enough about fishing to regulate bass harvest. All species of fish are harvested in unrestricted numbers as soon as they are large enough to take a hook. While this may not be considered sound pond management, it is important to illustrate what kinds of fish populations might be expected to develop in a pond fished in such a fashion. The outcome of unrestricted fish harvest will depend upon the number of bass harvested annually. One angler could remove the majority of the original-stock bass from a small pond in a day's fishing. Such a bass harvest would quickly allow bluegills to overpopulate the pond. Anglers rarely catch the last two bass in a pond, so

young bass may continue to be produced. If anglers continue to harvest the majority of bass produced, bluegills will continue to overpopulate and few large bass will be caught.

Some ponds receive little bass fishing pressure and harvest due to their remote location, because few people fish the pond, or because area anglers do not like to catch small bass. Such ponds eventually come to contain high numbers of small bass and large bluegills as described in the “Panfish Option.” The results from low bass harvest due to low fishing pressure or angler preferences are the same as those that occur with a 15-inch minimum length limit and high fishing pressure. Ponds that normally receive minimal bass harvest can withstand the harvest of an occasional 12-inch bass and even periodic high bass harvests without change because bass reproduction soon returns the pond to crowded bass and large bluegills. Other than habitat changes, annual harvests of 30 or more 8- to 12-inch bass per acre are the only way to increase numbers of larger bass. If harvest of small bass and 12- to 15-inch bass becomes continually high each year, the fish population will eventually become dominated by small bluegills.

### **Feeding Fish**

All ponds produce some natural food for fish. The amount of food produced is a function of the pond's productivity. Food quantity, in turn, determines what weight of fish the pond can support. The average amount of fish in a Kansas pond of average fertility is about 250 pounds per acre, of which only a portion (30 to 50 percent by weight) can be harvested per year.

Fish populations in most Kansas ponds are not harvested heavily enough to overtax natural food production. Supplemental feeding is thus not usually required. In special cases where the harvest demand is high or where large fish are desired, feeding can be beneficial.

Formulated fish feeds in pellet form are available at most feed stores. The most common feed is formulated for catfish, but it is also suitable for bluegills. These feeds are available in the form of sinking pellets or floating pellets. The advantage of floating pellets is that the person feeding the fish can determine whether the fish are eating the feed.

Bluegills will eat artificial feed, but feeding alone will not usually increase the sizes of overpopulated bluegills. Adequate predation on small bluegills by bass along with the feeding can, however, result in increased bluegill growth rates and larger bluegills.

Channel catfish are practical to feed, either as the only species in a pond or together with other species. They quickly learn to eat artificial feed, and their growth rate increases. Both catfish and bluegill should be fed no more than they can consume in 15 minutes, up to a maximum of 20 pounds per acre per day. If fish are overfed, decomposition of wasted feed can result in oxygen depletion, killing fish. It is a good idea to monitor water temperature and

oxygen content. Feeding should occur daily or every other day when water temperatures are over 60°F. Once a feeding program has been started it should continue throughout the growing season unless the pond's oxygen content falls below 5 ppm at the surface. If it is stopped, fish will lose weight.

Muddy ponds or ponds less than half an acre usually do not produce enough bass and bluegills for consistently good angling. It is in such ponds that densities of 200 or more channel catfish per acre can be maintained through supplemental feeding.

### **Fertilization**

Fertilization of Kansas ponds is not recommended. Phosphate and nitrate fertilizers are used in some states to increase productivity in ponds. Kansas' typically rich soils make this unnecessary. Fertilizers are also used in some states to control excessive rooted aquatic vegetation. Fertilizers will cause microscopic plants (phytoplankton) to develop, shading rooted plants. Without light, rooted plants do not grow. Oxygen depletion problems often develop when a pond is fertilized, so the risk of fish kills always exists. In addition, if fertilization is stopped, rooted plants will grow back in even greater quantities than existed before fertilization.

### **Improving Undesirable Fish Populations**

Undesirable fish populations can develop if bass numbers are low, if bass were never stocked, or if the pond has turbidity or vegetation problems. If anglers catch mainly 3- to 6-inch bluegills and few or no bass are taken, it is likely that either (1) bass overharvest has occurred, (2) bass are not present, (3) bass cannot see to feed, or (4) excessive aquatic vegetation has made bluegill unavailable to bass. The first two problems can be rectified by stocking 50 8- to 12-inch bass per acre. If the pond has an underwater visibility of less than 12 inches or if over 50 percent of the surface area of the pond is covered by vegetation, these problems must be treated before bass are stocked. Procedures for dealing with "problem ponds" are discussed in the next section. If turbidity problems cannot be overcome, the pond owner might consider stocking 100 8-inch and longer channel catfish per acre and forget about trying to produce bass and bluegills. After 8-inch bass have been stocked in a clear pond, bass less than 15 inches long should not be harvested for a three-year period (two years if 12-inch bass were stocked). Then, one of the four management options previously described should be followed, depending upon pond owner and angler desires.

If only small bass and no bluegills are caught, 250 4- to 5-inch or larger bluegills should be stocked per acre. Then, bass harvest restrictions and stocking strategies should be followed as outlined in one of the four management options.

If the pond contains neither bass or bluegills and small bullheads and green sunfish are present, 50 8- to 12-inch

bass should be stocked per acre. Once the bullheads or green sunfish are under control, 250 4- to 5-inch or larger bluegills should be stocked per acre because bullheads and green sunfish will not provide adequate prey to sustain a desirable bass population.

In the absence of bass, bullheads and carp sometimes develop such dense populations that their bottom feeding activities roil the water severely. Even if bass were stocked in such ponds, they could not see to feed, and their impact on bullheads and carp would be negligible. Draining the pond is the most economical alternative for removing unwanted fish given these circumstances. If the pond cannot be drained, the fish community can be chemically removed. Liquid rotenone is the chemical most frequently used. The chemical kills only animals with gills and is not harmful to warm-blooded animals. It should be mixed at a volume of 1 gallon per acre-foot of water. The amount of rotenone required may be reduced if the pond's water volume can be lowered through siphoning or pumping. This is desirable because the chemical is expensive. District KDWP fisheries biologists can provide information regarding purchase of rotenone.

Treatment should occur when the water temperature is 70°F or above. In ponds smaller than about 2 acres, the chemical should be mixed into the water using the propwash of a stationary outboard motor. The front end of a small boat should be pointed into the pond's bank and the motor should be run in forward gear while the rotenone is poured slowly into the propwash. It is best to dilute the rotenone with water before it is poured into the pond so that the treatment is done gradually. The propwash will circulate the chemical to all depths of the pond. The motor should be run as fast as safely possible to assure maximum circulation. The front and sides of the boat should be tied to stakes driven into the pond's bottom to keep the boat from running up the bank.

It is important to change the location of the boat several times so that the mixing action reaches all areas of the pond. Shallow areas not reached by the propwash should be treated with a hand sprayer or by "bucketing" in the chemical. The mixing action is ineffective when the boat is only driven around the pond. While the upper 3 feet of water may be well mixed, little chemical will reach lower depths.

Rotenone may not reach all areas of large ponds or ponds deeper than 10 feet when the chemical is mixed with an outboard motor. The chemical should be pumped into areas not reached by motor mixing and into the deepest portions of such ponds. Fish can be stocked back into a pond within 3 weeks after rotenone has been applied.

### **Pond Problems**

Pond owners can encounter numerous problems when attempting to manage their ponds for fish production. Many of these problems can be prevented or at least lessened by

proper planning prior to pond construction and in the initial stages of area development and fish stocking. While it is usually easier to prevent potential causes earlier than it is to treat symptoms later, the following information may help pond owners deal with established problems.

### **Muddy Water**

Pond water needs to be reasonably clear for production of desirable sight-feeding fish populations. Clear ponds produce several times the amount of fish as turbid ponds. Most ponds will be muddy after a heavy in-flow, but in good ponds silt should settle out within a week. Water clarity should be at least 1 foot or more during most of the year. If the underwater visibility is less than 1 foot, fish production will be decreased due to water turbidity. This amount of clarity is necessary for the production of algae, an important component of the food chain or web. In addition to limiting food production, muddy water can reduce the success of fish reproduction, particularly bass.

To cure the muddy water problem, the source of the turbidity should be identified. An easy way to determine the cause of turbidity is to collect a jar of water from the pond. If the suspended silt settles out within a week and the water above it is fairly clear, the problem is probably due to wind action or the activities of some animals, such as livestock, fish like carp or bullheads, or crayfish. If after a week, the water in the jar is still muddy, the problem is due to the chemistry of the soil type suspended in the water. Often, the problem is a combination of factors.

### **Muddiness Caused by Soil Type**

This is the most difficult muddy water problem to cure. The turbidity is caused by the suspension of clay particles that repel each other and will not clump together to form a particle large enough to settle out. This problem can be treated by adding material which will cause these particles to clump together and settle out.

Agricultural grade gypsum (hydrated calcium sulfate), available from most fertilizer dealers, can clear colloidal clay problems temporarily. It should be scattered evenly over the surface of the pond at 12 pounds per 1,000 cubic feet of water or 525 pounds per acre-foot of water. An acre-foot is 43,650 cubic feet. To calculate the pond's volume in acre-feet, the surface area of the pond should be measured in square feet and multiplied by the average depth of the pond in feet. This figure is then divided by 43,560. Some ponds built with SCS assistance have acre-feet volumes calculated and on file. If the pond does not clear within four weeks and there is no other source of turbidity, one-quarter the original amount of gypsum should be added.

Another material that can be used to clear clay turbidity is aluminum sulfate (filter alum). This material will cause the clay to flocculate and settle out. An application of about

50 pounds per acre-foot of water will clear most turbid ponds within a week. Alum should be dissolved in water and then quickly sprayed over the entire surface of the pond on a calm day since wave action will break up the floc so it will not settle out. Alum has an acid reaction with the water, about 20 pounds of hydrated lime (calcium hydroxide) should first be added per acre-foot of water. Sometimes this liming will cause the clay to settle out.

Organic matter can also be added to water to settle clay particles. This treatment technique is preferred to the addition of gypsum or alum because organic matter increases the pond's productivity rather than decreasing it. Organic matter provides food for desirable bacteria. As the bacteria break down the organic matter, by-products cause the clay particles to clump together and settle out. Manure, weeds, hays, and cottonseed meal will all work. When organic matter decays, oxygen is consumed. Too much organic matter can cause oxygen deficiency in the pond. If organic matter is added, it is best to use something that will decompose rather slowly, such as dry hay. It should be applied at a rate of two small bales per surface acre at 14-day intervals. The bales should be pulled apart and scattered in the shallow water around the pond. No more than 4 or 5 applications should be made per year. Solid bales can also be placed along the shoreline every 40 feet, just into the water.

The above mentioned methods are only temporary measures. These treatments will probably have to be repeated each year (usually at lower application levels) and after periods of heavy water inflow. Ponds with chronic clay turbidity may be best stocked with channel catfish and minnows, in which case treatment of turbidity is unnecessary.

### **Muddiness Due to Wind and Erosion**

Strong Kansas winds often cause shoreline erosion and wave action which keep soil particles in suspension. The effect of wind can be minimized by the use of windbreaks and shoreline protection. A standard windbreak can be planted on the up-wind side of the pond to dissipate the prevailing summer winds. If the dam is eroding badly, it can be protected with rock riprap or seeded shoreline vegetation. Erosion on the rest of the shoreline can be lessened by deepening the shoreline during construction, thus eliminating mud flats. Eroded shores and/or mud flats on existing ponds can be stabilized by planting a water-tolerant grass, such as reed canarygrass or millet. Millet seed can be broadcast over the mud at 10 pounds per acre. Millet grows rapidly forming a dense cover but must be planted each year to maintain a stand.

### **Muddiness Due to Animal Activity**

Livestock having access to a pond will trample shoreline vegetation and wade in the water, especially during the summer. These activities stir mud which can then be carried



over the entire pond by wind and wave action. Livestock should be fenced out of a pond if production of fish is important. If livestock water is needed, a pipe through the dam to a tank below the dam will supply it. If this is not possible or feasible, all but a small corner of the pond should be fenced off. This limited livestock access will cause some muddy water but less than if stock had access to the entire pond.

Fish such as bullheads and carp will cause water to be muddy because of their feeding activities. Removal or control of these species has been described previously.

A dense crayfish population will cause pond water to be muddy due to their burrowing and bottom feeding activities which stir up the bottom mud. The introduction of predator fish, such as largemouth bass or channel catfish, will solve this problem. Ponds with a good population of predatory fish will not have crayfish problems.

### Aquatic Vegetation

All vegetation is not bad. A certain amount is needed for good fish growth and protection. Plants produce food for many insects which in turn are eaten by fish. They also provide habitat for many fish food organisms and cover for small fish. Plants produce oxygen, protect the shoreline from wave erosion, and serve as feeding and nesting habitat for wildlife.

Aquatic plants can become so abundant that they interfere with fishing, swimming, and boating. Excessive, vegetation can also provide too many hiding places for small bluegills so bass have difficulty controlling their numbers. This often leads to overpopulated bluegills. Periodic die-offs of dense vegetation, which usually occur after periods of cloudy weather, or when the water is muddy after a rain, or at the end of their growing season, can also threaten fish. Oxygen is consumed by bacteria that decompose dead plants. Low oxygen levels stress fish so they do not feed and grow and often die (summerkills and winterkills). Decayed plant material also produces offensive odors and imparts undesirable flavors to water.

### Identification

To control aquatic plants, it is important to know what type is causing problems. Aquatic plants can be grouped into four general categories: algae, floating plants, submersed plants, and emersed or marginal plants.

#### Algae

Algae are small plants which do not have true leaves or flowers. Different types of algae take on different forms. Microscopic, single-celled, free-floating algae are called phytoplankton. This form is used by microscopic animals (zooplankton) as food. Phytoplankton gives water a green to greenish-brown tint, but individual plants cannot be seen. Filamentous algae, commonly called "moss," consists of

masses of long, stringy, slimy, or cottony strands which float on top or just under the surface of the water. *Chara*, commonly called muskgrass or stonewort, is a larger form of algae which grows on the pond bottom and has stem-like and leaf-like structures. It is often confused with flowering aquatic plants. Filamentous algae and *Chara* are usually considered undesirable.

#### Floating Plants

This group includes plants which have leaves that float on the surface and roots that hang down in the water without being connected to the bottom. Duckweed (*Lemna*) and watermeal (*Wolffia*) are common members of this group.

#### Submersed Plants

These plants grow under water, are rooted in the bottom, have stems, leaves, and produce seeds. These plants usually consist of a long flexible stem with clumps of narrow leaves along the stem. Some species have leaves that reach the surface which are a different shape than the lower leaves. Common examples of this group which occur in Kansas are pondweeds (*Potamogeton*), bushy pondweed (*Najas*), coontail (*Ceratophyllum*), water milfoil (*Myriophyllum*), and water buttercup (*Ranunculus*).

#### Emersed or Marginal Plants

Emersed or marginal plants are rooted in the pond bottom and have parts extending above the water's surface. Shoreline plants are also included in this group. These plants usually occur in shallow water, but some species can grow out from shore, forming a thick belt of vegetation. Common examples of this group of plants are cattail (*Typha*), bulrush (*Scirpus*), rush (*Juncus*), cut-grass (*Zinzaniopsis*), smartweed (*Polygonum*), creeping water primrose (*Jussiaea*), arrowhead (*Sagittaria*), willow (*Salix*), and cottonwood (*Populus*).

### Control

If aquatic plants occupy more than 10 percent of the pond area, one of four categories of control can be considered. They are: preventative, mechanical, chemical, and biological.

#### Preventative

Prevention is always the best control method. Plants are common in ponds that have clear water, high fertility and extensive shallow areas. Plant problems can be minimized through pond construction. All shallow mud flats should be eliminated by digging the shore area to at least 3 feet deep with a 3:1 slope. Existing ponds with extensive shallow areas can be dug deeper during periods of low water.

High fertility can cause a plant problem because nutrients can be channeled into plants. It is desirable to avoid rich sources of nutrients, such as runoff from livestock holding areas or septic tank drainage.

#### Mechanical or Physical

Vegetation around the shore can be controlled by hand pulling, cutting, or mowing. Hand pulling is effective for controlling cattails, willow trees, and cottonwood trees while

they are small. As they get larger, chemical control is needed. Most submersed plants can be partially removed by raking or by pulling a chain or cable through the pond between 2 tractors.

Submersed vegetation can also be controlled by shading with dark plastic screen, similar to screening used for shade in greenhouses. A large piece of screen should be weighed down on the patch of plants. This compresses and shades the plants and they die. After two weeks, the screen can be moved to a new area. The advantage of this method is that fishing, swimming, and boating can take place over the screen.

All mechanical and physical methods are temporary and normally affect only a portion of the pond's vegetation. They must also be used frequently during the growing season.

### **Chemical**

It is important to identify the problem plants, since there is no all-purpose chemical for aquatic vegetation control. Different herbicides are effective on different types of plants. Since the status of chemical registration is always changing, specific chemical names will not be listed. Aquatic herbicides are available at most dealers that handle agricultural chemicals. County agricultural agents and district KDWP fisheries biologists can give recommendations on which specific chemical to use.

Chemicals are registered for specific uses. Directions on the label should be followed explicitly and precautions should be observed.

Many chemicals have restrictions on the use of water for a period of time after application. With some chemicals, fish should not be eaten for a period after application, or livestock should not drink the water for some time. These restrictions will determine which chemicals can be used.

Most chemicals are applied at a certain dosage per acre-foot of water in the affected water. Volume of the area to be treated can be calculated as described previously in the "Muddiness Caused by Soil Type" section or obtained from the SCS if they designed the pond.

Most aquatic herbicides will not harm fish if applied according to directions. They are most effective if applied during April or May as the vegetation begins to grow. If applied after May or if the growth is heavy, only half of the pond should be treated at a time. The second half of the pond should be treated two weeks later. If the entire pond is treated at once, bacteria decomposing the dead vegetation could consume all of the dissolved oxygen, resulting in a fish kill.

One chemical treatment per year is usually sufficient, but, in some cases, a partial treatment is needed later in the summer. Chemical control is only temporary and must be repeated almost every year. It is expensive but effective if executed properly.

Certain chemical dyes can be added to the water to shade out the plants. These also are temporary, and they impart an unnatural tint to the water for a period of time.

### **Biological**

The most effective form of biological control is use of the herbivorous fish, the white amur, commonly called the "grass carp." This fish is a native of the large rivers of China and Siberia. It will not reproduce in ponds because it requires large rivers for spawning. When small, it feeds on small crustaceans and insects. As it gets larger, its diet consists almost entirely of aquatic plants. It prefers some plants more than others but will eat most submersed aquatic vegetation found in Kansas. It has a voracious appetite and grows rapidly. Grass carp should be stocked at a density of 20 individuals per acre in ponds with severe vegetation problems. In larger ponds or lakes with only a narrow belt of vegetation, 10 per acre is sufficient. If adult bass are present, the grass carp should be at least 10 inches long when stocked to avoid predation. After several years, when vegetation control declines, half the number originally stocked should be restocked to maintain the population.

Since the grass carp is an exotic fish, its use is not recommended by some federal agencies. In addition, the fish is not permitted to be used by the public in some states. In Kansas, no such ban exist and grass carp are available from many commercial fish growers.

Fertilization can be used to control aquatic plants, but as stated previously, it can cause oxygen depletion problems and is thus not recommended in Kansas. Ducks, geese, or swans have also been used to control aquatic plants. They are aesthetically pleasing but can be messy.

### **Sealing Leaky Ponds**

It is discouraging to have a new pond fill with water and then see it go dry within a few weeks. Leaky ponds are common in some areas of Kansas, and almost all ponds will leak to some degree, especially new ponds. In Kansas, evaporation can be expected to range from about 4 feet per year in the eastern part of the state to about 5 feet per year in the west. Most evaporation occurs during the summer, especially in hot, dry, wind periods. During this time, about half an inch of water can be lost to evaporation each day. Water loss greater than this can usually be considered leakage. The pond owner can determine the pond's leakage rate by measuring the water level drop with a marked stick during a period of cold or very humid, calm weather.

Leaks in ponds may be the result of permeable sand, gravel, or fractured rock layers that either exist throughout the basin naturally or were exposed by construction. Improper bonding of the embankment to an impermeable foundation soil can also lead to leakage. Some ponds are constructed in areas where all the soil in the basin is permeable, so the leak cannot be pinpointed. Deeper ponds tend to leak more because of the increased water pressure on the porous areas.

Techniques are available to seal leaky and potentially leaky areas. Most sealing techniques are expensive and require considerable work.

### Soil Layer

If a small gravel or rock area is causing leaks, a bulldozer can be used to remove some of the problem material. The area can then be covered with a layer of soil high in clay (at least 10 percent clay) from some part of the basin. The added soil should be at least 1 foot thick and preferably 2 feet thick. This soil should be compacted as it is being deposited. A sheepfoot roller is recommended for serious leak areas.

### Bentonite

Bentonite is a clay material that expands greatly when wet. Mixed with sand or permeable soil and water, it seeps into pores making an impermeable layer. Bentonite is usually applied at 1 to 2 pounds per square foot of pond bottom (more in areas over 10 feet deep). The dry powdered form creates a protective barrier when placed in a thin layer and covered with several inches of soil. Powdered bentonite can also be uniformly applied on the pond bottom and then mixed into the top 4 to 6 inches of soil with a disc and compacted. This method is quite successful in sealing a pond, but the seal can be punctured if cattle walk on the muddy pond bottom. A leaky pond which contains water can also be sealed by pouring a slurry of bentonite or spreading granular bentonite over the surface of the pond. This technique is usually not as successful as applying bentonite to the dry pond bottom because it is difficult to achieve an even application of the material. Bentonite is available from most feed mills or well drillers.

### Salt

Sodium disperses clay particles, causing the particles to plug up pores in the soil. This sealing method is only successful if the soil contains at least 10 percent clay. Clay content can be determined through laboratory soil analysis at Kansas State University. Sodium compounds such as rock salt (sodium chloride) can be applied at 0.2 to 0.4 pounds per square foot, or soda ash (sodium carbonate) can be applied at 0.1 to 0.2 pounds per square foot. This material should be spread over the dry pond bottom and worked into the top 3 to 6 inches with a disk. Compaction helps this material form an effective seal, but, once the pond fills, livestock or anglers can break a salt seal by walking on the pond bottom.

### Livestock

Trampling a pond basin with cattle or hogs will sometimes seal permeable soil. Livestock should be fenced into the pond area and fed in the dry pond basin for several

months. The combination of the compaction of many hooves and manure and waste feed being worked into the soil sometimes makes a seal. This is especially effective if the pond basin occasionally becomes wet. However, the pond could fill up before the basin has been completely sealed.

### Gleization

For ponds with rock 2½ feet or more below the surface, organic matter can be used for sealing. The soil surface should be covered with about 6 pounds (dry weight) of livestock manure, straw, grass, leaves, or sawdust per square yard. An 8-inch protective layer of soil should then be placed over the organic matter. A biochemical reaction will take place between the soil and the organic matter to seal the basin.

### Liners

Plastic membranes which can be placed over pond basins are available. They are expensive and must be protected from rupture. If livestock are present, their access to the pond must be prevented.

### Polymers

An emulsion of oil-soluble resinous polymers can be used to seal a pond without draining. The effectiveness of this material varies with condition and character of the soil, water, and climate, as well as manner of application. It is expensive and is toxic to fish, but a pond treated with polymers can be restocked within a few days after the water clears.

### Old Filled-in Ponds

Many ponds that are 20 to 30 years old have filled in so exclusively that they are shallow with vast areas of aquatic vegetation. Ponds are temporary features on the landscape because they accumulate silt, debris, and decaying vegetation, eventually becoming marshes and even dry land. Although filling in is inevitable, some measure can be taken to slow down the successional process.

If a pond is reclaimed that has received excessive amounts of silt from erosion, soil conservation measures, such as terraces, grassed waterways, and minimum tillage should be implemented. Small dams can also be built just upstream from large impoundments to act as settling basins for silt.

Livestock trampling the shoreline can cause the pond's banks and the dam to slough in. In addition to benefiting fish production, the practice of excluding livestock from the pond also increases the life of the pond.

Aquatic vegetation settles to the bottom when it dies. Part of it decays, but a considerable amount of residue remains on the bottom, filling a pond in over several years. Vegetation control slows down this process.

Ponds that are filled in can be renovated, but the process is expensive. It is often easier to build a new pond if

other good sites are available.

If the pond is located at the only good site available, it can be deepened by dredging with a dragline. A cheaper method is to drain or pump the water out of the pond and let the bottom dry. If the bottom muck is too deep, it will dry very slowly, and the pond will fill with water before the bottom gets a chance to dry completely. In most cases, it is best to break the dam with a backhoe down to a level below the pond bottom. After drying for about a year, the pond bottom should be firm enough for a bulldozer to push out the sediments. This material can be pushed out to the back side of the dam, and the break can be patched and packed with clay soil. It is important to "stair step" both sides of the break from bottom to top and compact each layer of added clay separately. The pond side of the dam should also have a new layer of soil pushed up against it and packed to be sure the dam is resealed.

### **Fish Kills**

Fish populations commonly have high mortality rates. In some ponds, one-quarter to one-half of all fish present will die of natural causes each year. This mortality takes place throughout the year. Many fish succumb to predation. Fish dying from other causes are usually quickly eaten by scavengers, so dead fish are seldom seen. On some occasions in some ponds, noticeable mass mortalities of fish do occur. Once dead fish are seen, it is usually too late to do anything, but knowing the possible causes can sometimes help the pond owner prevent fish kills from recurring or at least reduce their severity.

### **Pesticides**

A variety of chemicals are being introduced into our environment, and those used in agriculture can gain access into ponds. Some pesticides are extremely toxic to fish, and others are low in toxicity. Most herbicides used today have a low toxicity to fish, and most persistent insecticides have now been banned from use. Many of the currently used insecticides are short-lived, especially when exposed to water and are usually broken down and non-toxic by the time they get into ponds. Problems can, however, occur when someone carelessly sprays a pond while spraying a field, or when heavy rains wash pesticide-loaded silt into a pond immediately after application on a nearby field. Washing out a spray tank and equipment in a pond can also cause fish mortalities.

It is difficult to establish with certainty that a fish mortality was related to chemical use. Analysis of water samples is expensive and time consuming, and chemicals will break down by the time analysis is possible. Circumstantial evidence can be used in determining whether chemicals caused a fish kill. The pattern of mortality is usually the best clue. In a chemical poisoning, small fish

die sooner than large fish, and all species of vertebrates including turtles and frogs are affected.

In addition to massive fish kills, pesticides can have long-range effects on fish production if sub-lethal dosages are continuous or repeated. Pesticides may effect food organisms; they may alter fish reproduction; or they may be an added stress, causing decreased resistance to low oxygen levels and diseases.

### **Winterkills**

Fish kills are common during the winter in Kansas. Mass mortalities are noticed in late winter when ice cover disappears. This type of mortality is caused by oxygen depletion under the ice. A long period of snow cover on the ice is usually clear enough to allow sunlight penetration so that plants can produce oxygen, but snow cover greatly reduces the amount of light penetration so plants are unable to produce oxygen. Instead, there is a steady decline in oxygen due to the decay of organic matter and respiration by bacteria and other organisms. If snow persists long enough, complete oxygen depletion will occur. Winterkill ponds are typically shallow and have a high organic matter content commonly in the form of decaying vegetation or livestock wastes.

Winterkills can often be prevented by controlling aquatic vegetation and reducing the amount of livestock or other wastes that get into the pond. Water depth in Kansas should be at least 8 feet going into the winter to hold enough oxygen to carry fish through a normal period of ice cover. Pond that rely on surface runoff should be built at least 10 feet deep in eastern Kansas and 15 feet deep in the western part of the state. Removal of snow from the ice may prevent winterkill, but this usually requires considerable effort. Another effective way to prevent winterkill is to place an aeration device on the pond bottom or to install a water circulator to keep an area free of ice. Much of the water is then exposed to the air for oxygen absorption. Just cutting a hole in the ice is not effective since too little water gets exposed to the air.

### **Summerkills**

Summerkills are massive fish mortalities which occur during the summer due to oxygen depletion. The chain of events leading to summerkills was described in the "Aquatic Vegetation" section. Fish mortality due to summerkill usually occurs early in the morning, at which time the dissolved oxygen in the pond is at its lowest level. The mortality pattern is different than occurs due to pesticide poisoning, with larger fish dying first and frogs and turtles not affected.

Summerkills can be prevented by keeping aquatic vegetation from becoming too abundant. Excessive nutrients should also be prevented from entering the pond.

This will reduce heavy algae blooms. If a fish kill is beginning or about to begin (fish are gulping for air at the surface), heavy mortality can often be prevented by pumping fresh water into the pond or by installing an aeration device.

Summerkills are common in fish feeding programs where high densities of fish are crowded into small, shallow ponds. The addition of the organic matter in the form of feed can deplete the oxygen content in the pond.

### Diseases and Parasites

Fish are affected by a wide variety of diseases and parasites just like any other group of animals. Diseases can be caused by viruses, bacteria, or fungi. Fish are most susceptible to diseases in early spring when their resistance is low coming out of the winter. In most cases, mortality is not extensive in pond fish populations. Diseases are a greater problem where fish are crowded as in hatcheries and commercial operations. Disease diagnosis is difficult, and treatment is expensive and usually not feasible except in large investment situations, such as fish farming.

Most fish will have at least a few parasites. Parasites may be protozoa, flukes, tapeworms, roundworms, leaches, or crustaceans. A healthy fish can tolerate some parasites and show no ill effects. It is difficult to rid a pond of parasites, since there are a variety of parasites that can be readily introduced from a variety of sources. The best way to keep fish populations healthy is to maintain good water quality and prevent overpopulation.

“Black spot” and “yellow grub” are the fish parasites people most commonly encounter. Black spot (or black grub) consists of small, round, black grains (about pinhead size) embedded in the skin and flesh. Sunfish and minnows are commonly affected. Yellow grubs appear as small yellow or white nodules under the skin and in the flesh, especially near the base of fins and the tail. These parasites are found in many species of fishes, but are most noticeable in largemouth bass. The yellow grub is an immature stage of a parasitic flatworm which has a complicated life cycle. The adult worms live in fish-eating birds, such as kingfishers or herons. The eggs are expelled into the water and hatch, producing larvae which enter snails. They then undergo massive asexual reproduction and numerous free-swimming individuals are released. These penetrate fish and become embedded. This is the stage that is readily observed by anglers. When the fish-eating bird eats the fish, the grubs have a chance to become adults and complete the cycle.

Most fish diseases and parasites are specifically found in fishes and are not harmful to man, especially if the fish flesh is properly cooked before eaten.

## *Muskrat and Beaver Control in Ponds*

### Identification of Damage

Musk rats damage ponds by burrowing into dams and banks to make dens, thus increasing the chance of seepage and erosion. Den openings are about 5-6 inches in diameter and are usually near the surface, though in ponds with frequent water level fluctuations they may be in deeper water. In clear water, dens are usually visible, but in turbid water, they must be detected with hands, feet, or a pole. When ice appears, trails of bubbles and chewed vegetation will lead to active dens.

Beavers burrow into dams and banks, cut trees, and plug outlet tubes. Their work is conspicuous, and they are extremely persistent. Bank dens are 12 to 18 inches in diameter and will be present whether a dammed lodge is present or not. In fall and winter, a pile of fresh cuttings will be evident near the lodge or main den.

### Prevention of Damage

Muskrat damage is unlikely in ponds where the dam is sodded, ungrazed, and built to SCS specifications. Hard clay should be used in construction to discourage burrowing. To control burrowing after it has begun, all muskrats in the pond should be trapped and affected areas should be riprapped. Wire mesh or fencing can also be used, but these materials yield to corrosion after several years. If all muskrats are not removed, survivors will find a way to reopen their traditional burrows.

Beaver burrows are big enough to damage even well-built dams. Riprap will discourage initial burrowing, but all beaver must be trapped if burrows are to be sealed. If burrows break through the surface of the dam, the opening should be collapsed as far back as possible and filled with clay.

To keep beaver from plugging outlet tubes, the pond owner should string electrified fence wire around the tube and connect it to a fencer and battery. Wood or fiberglass posts should be used or the system will not work. After beaver have been shocked a few times, the power can be turned off until problems recur. Outlet tubes are easier to keep free of debris if they are covered with a heavy trash rack of welded metal which is periodically cleaned. Light “chicken wire” should not be used as it cannot be cleaned. To prevent cutting of trees, bases should be wrapped with ¼-inch wirecloth or similar fence material. No effective repellent is commercially available.

### Population Control

Sustained population control is the best damage prevention method available for both animals. Small stable populations of muskrats and beaver will do little damage. Pond owners should not wait until furbearers become

overabundant before initiating control, because by then the damage has been done.

For most pond owners, the most feasible method of population control is to have a local trapper work the pond every year. Everyone, including the surviving animals themselves, benefit from this arrangement. The pond owner keeps problems to a minimum; the trapper earns money for pelts; and the animals are kept within the capacity of the pond to support them. If the pond owner wishes to try trapping beaver and muskrats, he should contact the Kansas State University Extension Service or the nearest KDWP office for detailed information on proper equipment and methods. These agencies can also provide names of trappers who are available to help with problems.

Both muskrats and beaver can be live-trapped, although equipment costs may be prohibitive. Beaver can be taken in suitcase-style Bailey or Hancock traps, and muskrats can be taken in wire box traps (Havahart type) that are set on a float made from 2- by 8-inch boards. Poisons are not recommended for beaver or muskrats due to undesirable effects on non-target species (particularly fish).

### ***The Role of Crayfish in Ponds***

When a pond owner discovers that his pond has crayfish, an image of a leaky pond comes to mind, followed by thoughts of how to eradicate them without harming fish. Without much effort, crayfish can be managed to provide benefits for the pond owners.

Crayfish burrows rarely cause ponds to leak. Controlling crayfish in established ponds is best done by stabilizing the water level. Crayfish reproduction is closely tied to changing water levels and is most successful in waters that have regular seasonal fluctuation patterns. Wire basket traps or lift nets baited with meat can remove large numbers of these crustaceans in short periods of time.

Having crayfish in a pond isn't all bad. In the process of eating minute plants that grow on submerged vegetation, crayfish also eat larger pond plants, giving limited vegetation control. Since crayfish are consumed as prey throughout their lives by bass, bluegills, and channel catfish, they also provide benefits as a fish food. Catching crayfish using a fishing rod can sometimes be as much a sport as angling. Substituting crayfish for crab, shrimp, or lobster in recipes offers an excellent table fare for a fraction of the cost.

### ***The Roles of Turtles in Ponds***

Most pond owners and anglers view turtles as a threat to fish communities in ponds. Such is not the case. Turtles are primarily scavengers, feeding on dead or dying fish and other aquatic organisms. They thus serve to clean the pond more than cause harm and should not be indiscriminately destroyed. Turtles may cause problems by stealing bait and even fish from stringers. Snapping turtles may also prey on

small ducks that hatch around the pond.

If the pond owner enjoys turtle soup, stew, or fried turtle, or if turtles become too plentiful, they can be removed by trapping. An effective trap can be constructed by attaching a hardware cloth or "chicken wire" bottom to a square, four-board wood frame. A slanted board is then nailed to the outside of the trap, leading to the top edge. It serves as a ramp on which turtle can crawl out of the water to the trap. A metal rod is driven horizontally through two of the frameboards. The rod is also passed through another "teeter" board which extends from the edge of the trap to near the middle. When the turtle crawls to the end of the board, his weight will tip it forward and he will fall into the trap. A tough piece of fresh beef or pork should be suspended in the middle of the trap for bait. To keep the turtle in the trap, 20 D nails should be driven into the frame, slanting upward, 4 inches apart, 2 inches above the water.

### ***The Role of Frogs in Ponds***

Frogs need water to reproduce. Masses of gelatinous eggs are often found in pond water during spring and summer. In Kansas, the bullfrog is the only common species that has a tadpole stage lasting longer than a year. All others will develop into tiny frogs the same season the eggs are laid. These amphibians are in interesting addition to the aquatic ecosystem, but they usually do not substantially help or hinder the fish community. The adults are quite mobile and often leave the pond. Bullfrogs, however, will take up residence by a pond and can usually be seen sitting on the edge of the water. Frog legs are tasty, and frog harvest during the legal season is another benefit of a pond.

Frogs are rarely a problem because bass and other predators usually keep populations low. Bullfrog tadpoles can become a problem in channel catfish-only ponds or minnow ponds because they can become abundant. Excessive numbers of tadpoles can be reduced by seining, and the adults can be eliminated by capturing them during the legal frogging season.

### ***Fishing The Pond***

#### ***The Angler's Responsibility***

Since ponds are located on private property, it is the responsibility of the angler to obtain permission before fishing. If the pond has been stocked with fish provided by the KDWP in the last 10 years, the angler must obey all statewide regulations. A copy of these regulations is available from any KDWP office and from many sporting goods dealers. In addition, the pond angler should be aware of any other restrictions that the pond owner may have imposed, such as bass length, number, or poundage limits.

Access to ponds is usually not difficult if the angler makes a point of informing the pond owners that he

respects property and appreciates the privilege of fishing. An angler is, however, likely to have problems convincing a pond owner of his sincerity if the pond owner has experienced cases of vandalism or thoughtlessness in the past. To keep ponds from becoming totally private, anglers may need to take a more active part in pond management. Perhaps more pond owners would be willing to allow fishing access if more anglers were physically and monetarily involved in carrying out management practices described in this booklet.

### ***Bass Fishing Techniques***

Pond bass fishing can be an exciting and rewarding adventure. More big bass are harvested from ponds than from any other water type in Kansas.

The bass is probably one of the easiest fish to catch, which explains why overharvest of bass in ponds is so prevalent. One angler can overharvest the bass in an acre pond in a single successful fishing trip if bass are actively feeding.

Small bass will bite just about anything tied on the end of a fishing line. Artificial baits such as spinners, jigs, beetle spins, plastic worms, and surface lures are deadly. Yellow, purple, and black are the preferred colors. Natural baits such as minnows, worms, frogs, crayfish, and grasshoppers will also catch bass. Big bass will also hit any of the above baits but not as readily as smaller fish. Technique is important if the angler wants to catch big bass.

Techniques vary according to the season. Spring time in a pond means cold water and relatively inactive bass. They will move to the shallows during the day as the sunshine warms the water but are difficult to catch there. Slow moving spinners or small jigs should be fished near habitat structures or along steep drop-offs at this time of the year. Bass may also be caught in deep water along the edges of vegetation.

As summer approaches, bass move to the shallows to spawn and can be caught fairly easily. Plastic worms and fast moving lures, such as spinner baits work well. Minnows and crayfish fished around shoreline habitat will also produce bass in this May-June period.

Hot summer days mean warm water temperatures, probably pond stratification, and vegetation growth. This drives bass to shady areas around shallow habitat. Bass are aggressive at this time, and surface lures, popping bugs, and floating plastic worms excite them. Grasshoppers and frogs make excellent summer baits, either fished on the surface or hung 12 to 18 inches under a bobber. Many times, bass will come out of the water to hit a bait in the summer. Nighttime fishing may increase success even further.

Fall weather cools the water and bass feed actively, fattening up for the winter. Surface baits become less

effective as the water cools so the angler should again use spinners, beetle spins, or plastic worms. Minnows are a good fall bait. The angler should fish around any existing habitat (brushpiles, vegetation or fallen trees).

During the winter, bass are slow, sluggish, and finicky, but they can be caught through the ice on small minnows or jigs smaller than  $\frac{1}{16}$  ounce. Deep brushpiles, habitat structures, or areas near deeper parts of the pond should be fished in the winter.

### ***Bluegill Fishing Techniques***

Bluegills can be caught using nearly any fishing rig known to man, but the most successful bluegill anglers use a delicate approach. In most cases, that means 2- to 6-pound test line, a number eight hook baited with a worm or grasshopper, a single split shot for weight, and a thumbnail-sized bobber in situations that require flotation.

It isn't necessary to cast to a bluegill; many top-notch anglers just reach out and drop the bait on him. The cane pole most fisherman learned on is an excellent tool for bluegill fishing. Its length lets an angler present the bait quietly from a distance, and the spring in the pole is more than any bluegill can handle. Some fishermen use flyrods for the same purpose, dangling a baited hook under heavy cover along the bank or in flooded brush. Casting with an ultralight spinning rod is also an effective as well as sporty way to catch bluegills. This approach, regardless of the type of rod used, is the most effective year-around method for catching bluegills.

Bluegills are particularly vulnerable to the fly fisherman when they're on their spawning nests or "beds" in shallow water during June. The biggest fish take the preferred locations on the beds usually next to the bank under an arch of brush. A flyrod expert who can lay a popper, fly, or rubber spider into these tight spots can often catch several bluegills in succession.

Before the bed fishing gets hot, bluegills can be taken with ultralight spinning tackle. The fish are sluggish until the water warms up.

They react slowly to bait, and take it delicately when they decide to bite. A small ( $\frac{1}{16}$  ounce or less) jig suspended under a small bobber is a good rig for this early fishing. It casts surprisingly well and lets the fisherman work the bait slowly, vibrating the bobber a few inches across the water, then letting it sit for half a minute. This technique gives the jig a subtle action and lets the fish make up his mind and move in.

Ultralight spinning tackle with small jigs or spinners also work well in midsummer after the fish have come off their beds. Bluegill and most other fish move into deep water during the heat of the day and come into the shallows to feed at dusk and especially at dawn when water temperature is at its lowest. Fishing for bluegills with a cricket or

small worm works well through the summer, too.

Bluegills are the staple for ice fishermen who work small ponds. Bluegills congregate in the deepest holes around cover in the winter. A red wiggler angle worm fished a foot or so off the bottom works well, especially when it's attached to delicate tackle—2-pound line, one split shot, and a tiny bobber.

### *Channel Catfish Fishing Techniques*

Still fishing is the best and most sporting method for catching pond catfish. Channel catfish in ponds generally bite on the same baits as those in other waters. Earthworms and smelly baits, such as shad sides, chicken and turkey livers, shrimp, sponge baits, and prepared baits will all attract, hungry catfish. If the angler doesn't have bait with him when he goes fishing, he may be able to catch his own at the pond. Leopard frogs, crayfish, and bluegill halves make excellent catfish bait.

Channel catfish begin feeding as soon as the ice goes off in the spring. Shad or sponge baits work well, but the crayfish is the mainstay of the catfish diet in the spring. As summer approaches, catfish feed more actively and can be taken just about anywhere in the pond as long as the bait is on or near the bottom. Good late spring baits are worms, liver, and shrimp.

Summertime weather will likely cause a pond to stratify, and fishing for catfish in the deep parts of the pond is then a waste of time. Baits should be fished below a bobber, seldom deeper than 4 to 5 feet. If the angler wants to fish on the bottom, he should cast along the edges of vegetation or around fish attractors in water less than 5 feet deep. The most exciting fishing during the summer months in ponds occurs during or right after a heavy rain. Catfish feed actively on food that washes in, and the angler can fill his stringer in a hurry by fishing earthworms on the bottom in shallow water near the upper end of a pond.

Fall pond catfishing is much like spring fishing. As the wind mixes the water column, catfish feed throughout the pond, and grasshoppers generally replace crayfish as the best natural bait. Fishing will become more difficult as the water cools. The angler should fish deeper water and be patient.

### *Cleaning and Preparing Fish*

To some, the fun is over when the fish are caught because cleaning fish is an unpleasant task. This attitude is most common among those who are not aware of the cleaning technique best suited for the fish species they have caught. Once proper techniques are learned and applied, the task becomes a small price to pay for the delicious eating that is yet to come.

The most common method of cleaning catfish is to make an incision around the body in back of the head, after which the skin and fins are pulled off with pliers or a skinning tool, the body is cut open, the entrails are removed, and the head and tail are cut off. The fish is then washed, dipped in batter, and fried. The bones remain in tact, but it is an easy matter to pick large pieces of meat off large bones.

Other fish species can be scaled with a teaspoon or scaling tool and then cleaned much like catfish. The problem is that most people don't like to pick through small bones of several small fish to find small pieces of meat. Filleting is thus a much preferred method of cleaning for most fish besides catfish, and even catfish lend themselves well to filleting.

Without question, filleting is the most efficient method of cleaning fish. The traditional tool for filleting fish is the flexible, thin-bladed, razor-sharp fillet knife. An electric knife can also be used as a filleting tool. Once the electric knife technique is mastered, the time involved in fish cleaning chores will be reduced.

There are two types of electric knives on the market. One has a straight handle with a trigger on the bottom operated by the forefinger. The second type has a large moon-shaped handle with a trigger button on top operated by the thumb. The knife with a straight handle allows for better leverage on the blade and works much better for filleting than the other model.

To fillet a fish using either a fillet knife or an electric knife, the angler should grasp his fish by the head with one hand and lay it on one side. A vertical incision is then made just behind the gill cover from the nape of the neck to the belly, down to the backbone. The knife is then run horizontally along the backbone, cutting through the ribs. Just before the knife reaches the tail, the fillet is flipped off the carcass, and the skin is sliced off the meat by pressing the knife blade flat on the cleaning surface as the cut proceeds toward the ribs. The ribs are then cut from the fillet. This process is then applied to the other side.

This conventional filleting technique works especially well on large fish like bass and walleye. For panfish like crappie, and particularly bluegills, there is yet another approach. The first step is to scale both sides of the fish thoroughly. The fish is then dipped in a bucket of clean water to remove loose scales and mucous. A small fillet knife is inserted into the nape of the neck. This knife is run along the top edge of the ribs next to the bones which branch off the spine. After the knife has passed by the ribs, the cut proceeds toward the belly with the tip of the knife exiting the fish at the front edge of the anal fin. The cut continues all the way out of the tail. A vertical incision is then made just behind the gill cover and the fillet is pulled and sliced off the ribs. The fillet is separated from the



carcass along the belly by cutting from the vertical incision made previously to the front of the anal fin. The fish is then flipped over and the cutting progress is repeated on the other side.

By leaving the skin intact, the fillet holds together better, fries up crisper, and has more flavor (pleasing, of course). In addition, cutting along the outside of the ribs and then out at the bottom of the fish salvages a bit more meat along the belly. This area is discarded when ribs are cut out in the conventional method. The conventional method also wastes some meat near the tail. In both areas there isn't much wasted using the conventional method, but every little bit counts, especially when cleaning fish as small and as good tasting as bluegills.

## ***Law Enforcement and the Pond***

### **Laws and Regulations that Apply to Ponds**

To understand the rules that apply to ponds, one must first understand the legal definition of a private pond. To be considered a truly private pond, a water body must have been constructed rather than be natural. It must be located entirely on the property of only one landowner or lessee.

Except during floods, the private pond must have no connection with streams or other bodies of water which would allow the passage of fish between the two locations. The private pond may, however, be connected with a stream or other body of water by a pipe not more than 8 inches in diameter if it is screened to prevent the movement of fish between the two locations. To be deemed a truly private pond, it cannot have been stocked with fish provided by the KDWP within the last 10 years. Once stocked by the KDWP, a pond loses its private impoundment status for a decade.

No one is required to have a state fishing license to fish in a private pond. On all other ponds (hereafter referred to as "non-private ponds") only certain persons are exempt from the license requirement. The landowner or tenant and family members living in residence may fish a non-private pond without having a fishing license. Kansas residents on leave from active duty in the armed forces, residents under 16 years old or over 65 years of age, and non-residents under 16 are not required to have a license. Everyone else must have a license in possession.

Both private and non-private ponds are open to fishing year-round. On those impoundments legally qualifying as private ponds, no daily creel or possession limits apply. On non-private ponds, such as those stocked by the KDWP within the past 10 years, the limits established by regulation apply. No bass length limits are in effect on private or non-private ponds other than those imposed by the pond owner.

Lawful fishing methods vary according to the pond's status. Anyone may take a fish from a private pond by any means except those using a substance which could escape

to endanger or kill fish in other waters. On non-private ponds, all anglers, including the owner and tenant, may take fish only by methods established by regulations. A landowner, tenant, or other anglers could thus take fish by seining a private pond, but no one could use this method on a non-private pond.

The landowner or tenant may raise fish for commercial use in a private pond, but sale of fish from non-private ponds is prohibited. The taking of bullfrogs from ponds is also regulated. The license requirements, open season dates, lawful methods, and daily limit are exactly the same for both private and non-private ponds and public waters.

Any landowner or tenant has the right to restrict access to a pond on land in his ownership regardless of whether the pond is private or non-private. One who enters onto another's property without permission is violating the law. Just because KDWP has stocked a pond or because it doesn't qualify as private according to the legal definition doesn't mean a landowner can't regulate who uses his property. Since 1990, the owner must sign an agreement form which states he will allow access to persons who ask permission to fish for 10 years after fish are stocked and nine years thereafter. As stated earlier, the pond owner has the right to refuse access to anyone who previously destroyed property or exhibited other undesirable behavior.

### **The Law Enforcement Officers' Capabilities on Ponds**

Wildlife Conservation Officers (WCO) and other law enforcement officers have the right to enter upon private property in the performance of their duties. There is little for the officer to regulate on a truly private impoundment where fishing is concerned because no licenses are required, and nearly all harvest methods are legal. He might, however, find it necessary to check on bullfrog harvests from such ponds. On non-private ponds, the officer's responsibility increases. Here he may check for compliance with all the regulations that apply to fishing and frogging.

### ***Fish Facts and Fallacies***

The mucous on a fish's body serves to protect it from diseases and reduces friction between the water and the fish's body. A fish that is to be released should thus be handled gently, preferably by the lower jaw, to avoid mucous loss. The angler should also wet his hands before touching the fish.

Although a fish does not have external ears, sound vibrations are transmitted to inner ears and the air bladder. The lateral line which extends down a fish's side is used to detect low-frequency vibrations and aids in avoiding collisions and capturing prey.

Fish have nostrils used to smell, and a catfish's barbels are used to taste. Catfish also have venomous glands associated with their dorsal and pectoral spines.

Fish have a poorly developed nervous system as compared to man. Rather than feel pain, a hooked fish senses only discomfort.

Fish cannot regulate their body temperature. They become less active in cold water because their body temperature matches that of their surroundings.

Fish do not have eyelids, but they “sleep” by hovering in open water, on the bottom, or near an object.

The age of a fish can be determined by examining a scale or certain bones. A 10-year-old fish would be

considered a “senior citizen” in Kansas. Most fish here live no longer than 6 to 8 years.

Fish do not gain access to a pond on birds’ feet or in birds’ bodies. Fish eggs die quickly when dry and would not survive even a short flight. Eggs that are eaten are quickly digested. Fish are introduced into ponds by someone or from nearby creeks or ponds that have flooded.

There are more than 20,000 fish species on earth. Of the 142 species inhabiting Kansas waters, only 29 are regularly caught by anglers and only 19 are commonly harvested.

## Questions for Chapter 26

1. Why does poor fishing exist in some Kansas ponds?
2. When are permits required to build a pond?
3. List three construction features and explain how they make the difference between a good and average pond?
4. What are fish attractors?
5. How does water quality influence pond fishing?
6. When stocking ponds, what things need to be considered?
7. How does fishing intensity impact predatory fish size?
8. How do you control unwanted aquatic vegetation growth?
9. Do fish sleep?

Name \_\_\_\_\_





PRIVATE  
LANDS

SECTION VI

WILDLIFE

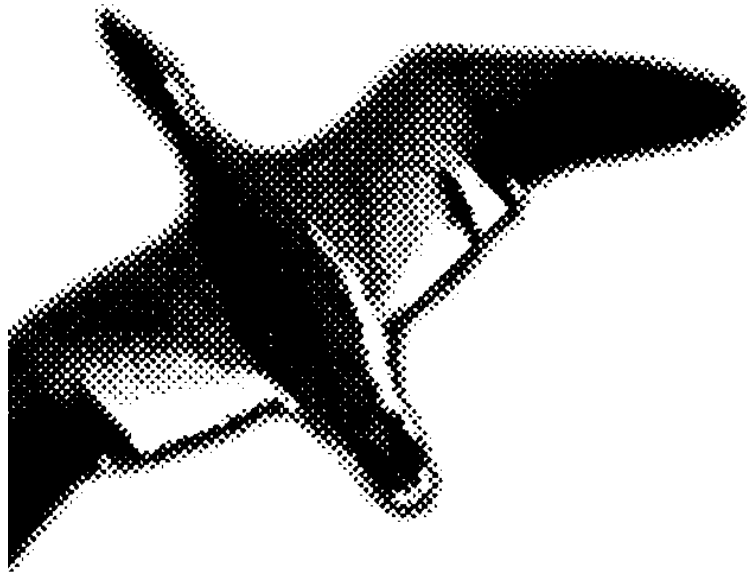

WILDLIFE  
MANAGEMENT

A Technical Manual  
&  
Correspondence  
Course

## Chapter 27

# Ring-Necked Pheasant Management

Randy Rogers

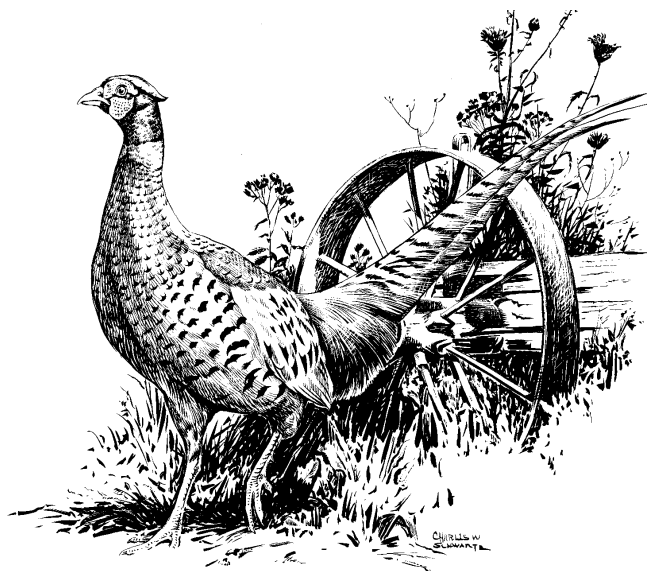

The ring-necked pheasant is probably the most popular upland game bird in North America. In Kansas, their range includes all but the southeast corner of the state with the greatest densities being found in the northwest and northcentral regions (Figure 1).

Native to Asia, pheasants were first introduced to Kansas in 1906 and the first hunting season occurred in 1917. Peak populations were reached during the 1950s, but declined thereafter due to trends toward clean farming. A secondary peak occurred in Kansas during the early 1980s, possibly in response to a decrease in farm tillage caused by high fuel prices.

## Life Cycle

Ringnecks are closely tied to agricultural lands. They have adapted to a wide variety of grain cropping systems. Sixty to 80 percent of an adult pheasant's annual diet consists of grains such as sorghum, corn, or wheat. Virtually all of these grains are picked up as waste that has fallen on the ground. Their dependency on farming makes them particularly sensitive to farm practices, both locally and regionally.

Pheasants have a polygamous mating system. That is, one rooster can attract and mate with a harem of several hens in the spring. Since there are roughly equal numbers of roosters and hens produced each year, a surplus of roosters is available each fall which is not necessary to ensure normal reproduction in spring. This surplus of roosters and the obvious differences in plumage coloration between sexes makes possible the roosters-only hunting seasons in use in Kansas and throughout the country.

Hens generally begin nesting in April or May and lay an average clutch of about 12 eggs. It takes about two weeks to complete a normal clutch before the 23-day incubation period can begin. The entire nesting phase takes from five to six weeks to complete if it is not interrupted, and the peak of pheasant hatching usually occurs during the first three weeks of June in Kansas. If the nest is destroyed before hatching, the hen will often attempt to renest. Renesting, however, places very stressful demands on the hen's physiology, so clutch sizes are generally smaller and hatching success is less with second or third nesting attempts. Renesting attempts generally stop by the end of June. If a hen successfully hatches her eggs, but then loses the brood, she will not renest except under very rare conditions. Consequently, production of more than one brood by a single hen virtually never occurs in pheasants.

After hatching, the hen leads her precocial chicks to suitable habitat where they can find abundant small, soft-bodied insects. Pheasant chicks eat insects almost exclusively for the first four weeks of their lives and continue to require substantial amounts of insects during their first summer. The insects provide the high-protein diet and moisture critical for their survival and growth. The hen generally remains with the chicks until they are 6 to 8 weeks old but may leave sooner or stay longer depending on her own condition.

Heaviest losses of chicks occur during the first few weeks of life. During this period, they are most vulnerable to weather extremes (chilling or overheating), inadequate food supplies, and predators. Good brood habitat shelters the chicks from all these dangers and is critical to overall pheasant production. Pheasant broods often concentrate in patches of good brood habitat and may sometimes combine, creating mixed-age broods. Such broods are often mistakenly cited as evidence of multiple hatches from a single hen.

By late summer, broods begin breaking up and pheasants may move as individuals or in small, loose-knit groups. The young have nearly reached full adult stature by 16 weeks of age but will continue to put on weight well into the fall.

As winter approaches, pheasants gradually gather into groups which can become large and sometimes are composed of all or mainly one sex. These groupings tend to develop in areas where heavy cover and a good food source are in close proximity.

Ringnecks are resilient birds capable of enduring considerable hardship in winter. They can scratch through several inches of snow to find food and can, if necessary, withstand periods exceeding a week without food during winter. In Kansas, pheasants seldom die directly from starvation as can occur in the northern Great Plains. Sudden severe blizzards, however, can result in substantial pheasant losses when the birds are caught far from adequate cover. Under such circumstances, death most often comes by freezing or suffocation. Physiological stress induced by severe winters or inadequate cover can reduce the ability of surviving pheasants to reproduce the following spring.

**Habitat Requirements**

Optimum pheasant habitat provides a variety of covers in close proximity to each other. These covers must satisfy the bird’s varying needs through the year. There are three critical phases in the pheasant’s life cycle, each requiring somewhat different cover.

**Winter**

Cover needs in winter are perhaps best understood because these are the covers in which pheasants are found during the hunting season. In general, winter covers must be

of sufficient height and density to protect the birds from bitter weather and provide concealment from predators. This can be supplied by a variety of herbaceous covers including tall native grasses, heavy weed patches, or wetland vegetation, such as cattails. Switchgrass often is a preferred winter cover because it has relatively rigid stems that retain their leaves providing a dense environment which stands well against the wind. Similarly, patches of weeds like sunflower, kochia, giant ragweed, or other broad-leaved plants can provide resilient cover. These heavy herbaceous covers are often suitable not only as daytime loafing areas but also as night-roosting sites. Weedy covers often yield the added benefit of providing a food source within the winter cover.

Woody covers are primarily valuable as daytime loafing sites and are rarely used for night-roosting by pheasants. Shrub thickets can be particularly valuable as can dense multi-row plantings of eastern red cedar. Narrow, linear plantings consisting of less than five rows are of minimum value to pheasants and can become death traps in severe blizzards when pheasants can actually be buried in drifted snow. Trees, except for red cedar (or other junipers), are of almost no value to pheasants. Tall deciduous trees can even be harmful to pheasants since they create ideal hunting perches for hawks and owls. Cattle should never be allowed access into woody wildlife cover.

No matter what the vegetation type, the area must be of sufficient size that it does not drift full of snow. It must also be close (less than 400 yards) to a good food source such as grain stubble, or the cover will be of little value to pheasants in severe winter weather. If food plots are provided for pheasants, care should be taken to place them near heavy herbaceous cover and well away from tall trees.

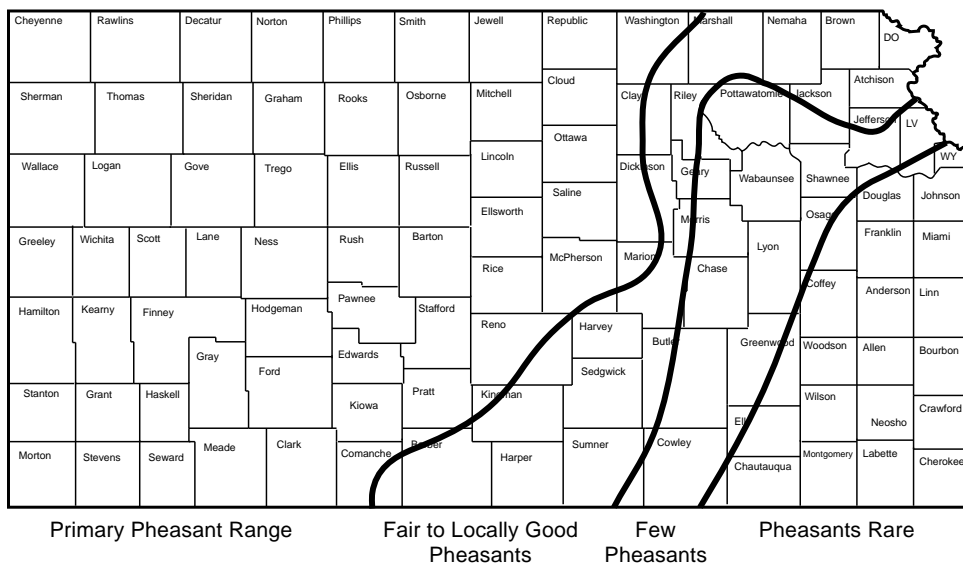

Figure 1. Generalized pheasant distribution in Kansas.

## **Nesting**

Nest cover need not be as heavy as winter cover, but nest sites usually provide good concealment. Residual vegetation in the form of grasses, weeds, or wheat stubble provide cover for initial nest attempts in spring. Switchgrass has been shown to be especially attractive to nesting hen pheasants. New green growth conceals most pheasant nesting later in spring.

It is critical to nest success that nesting cover remain undisturbed at least through June. Alfalfa and other hay crops can provide highly attractive nesting cover, but nests are seldom successful in these covers because of haying. Hay cutting also kills many hens that sit tightly on the nest during latter stages of incubation. Recently hatched broods are also vulnerable to the sickle bar. Destruction of pheasant broods during haying operations can be reduced by cutting initially through the center of the hay field and gradually working outward. This allows broods to move out of the field away from the machinery. In stark contrast, initial cutting around the outside of the hay field tends to force broods further into the field where they can be repeatedly decimated by the haying equipment. Proper haying of native warm-season grasses usually occurs in mid-July and poses relatively little problem for pheasant broods.

Losses of nests, incubating hens, and broods also occurs in western Kansas in wheat stubble during spring discing. Research has shown, however, that spring weed control with herbicides allows these early nests to reach completion in wheat stubble. Use of an undercutter without treaders for spring weed control in wheat stubble also will allow many nests to survive. Both of these techniques offer significant moisture storage and yield advantages compared to spring discing in western Kansas wheat stubble.

## **Broods**

Probably the most overlooked habitat requirement for pheasants and many other birds is good brood cover. As noted before, the chicks require small soft-bodied insects almost exclusively in their diet for the first four weeks of life. To survive this critical phase of life, the chicks must find habitat that contains a good supply of insects, such as leafhoppers, and crickets. In addition, the cover must be relatively open at ground level to allow ease of movement for the tiny chicks. It must also provide an overhead canopy that shelters the chicks from the hot sun and wind, from pelting rain or hail, and which hides the chicks from the eyes of predators.

Grasses, while ideal for nesting, generally are too dense at ground level to provide good brood habitat. Legumes, such as alfalfa and sweet clover, can be good brood cover, but haying of these covers make them dangerous for broods. Row crops can provide fair brood cover, but insecticide treatments in these fields can also be dangerous to chicks. Ideal pheasant brood habitat consists of broad-leaved weeds.

Weeds like sunflower, pigweed, kochia, or many others are good sources of the right kind of insect foods, and they provide the overhead canopy and relatively open ground level structure necessary for chick safety and movement. Weedy odd areas, roadsides, or field borders are critical brood-rearing areas. In western Kansas, weeds allowed to grow in post-harvest wheat stubble have been crucial to pheasant production and survival in many regions. Elimination of broad-leaved weed covers from the summer landscape has had highly detrimental effects on pheasant production.

Recent studies have shown that pheasant production can be dramatically improved if only a 20-foot strip around field edges is not treated with herbicides or insecticides. This allows some broad-leaved weeds to grow within this strip of crop and provides the habitat and beneficial insects needed by pheasant chicks.

## **Interspersion**

Pheasants prefer to live out their lives in a small area. Long-term movements are seldom greater than 3 miles, but daily movements are much more restricted. As a result, pheasants are most common in areas where all their life requirements are available in close proximity to each other. Consequently, good interspersion of cover types is important. A quarter-section that is all one field is of much less value than the same area divided into several fields. Add in good roadside cover, grassy or weedy field margins or fencerows, a few shrub clumps and weed patches in field corners or odd areas, and the quarter can be converted from poor to excellent pheasant habitat with little loss of crop acreage.

## **Land Use Considerations**

Since pheasants are so closely tied to the intensively used agricultural landscape, their numbers are highly sensitive to various agricultural practices.

Pesticides are a widely recognized hazard to pheasants. While it is recognized that some pesticide use may be needed, steps can be taken to minimize damage to pheasant and other wildlife populations. Farmers must always consider whether a particular pesticide treatment is necessary. Modest pest numbers sometimes cause less yield and income loss than the cost of control, and treatment is not economically justified. Frequent crop rotation and a variety of cultural practices can minimize pest build-up. Planting pest-resistant crop varieties can reduce the need for insecticide use.

Often, different but equally effective pesticides have very different levels of toxicity to wildlife. For example, parathion is often aerially applied to milo for greenbug control, yet this insecticide is extremely dangerous to wildlife. Malathion is equally effective, is much safer for wildlife, and can be applied with ground rigs saving the high



expense of aerial application. Some insecticide related deaths are not caused by direct poisoning but can result from temporary impairment in the animal's ability to avoid predators, feed, reproduce, or tolerate temperature extremes. If insecticide application is necessary, it is important for farmers to try to use the least toxic, effective chemical available. Specific pesticide toxicity information can be obtained from the KDWP or the U.S. Fish and Wildlife Service.

If insecticide application is considered necessary, avoid spraying habitats, such as field edges, odd areas, and wetlands.

Herbicides are seldom directly poisonous to pheasants. They pose a far greater threat to pheasant populations by breaking food chains and altering habitat structure. As mentioned earlier, broad-leaved weeds provide critical habitat where pheasant chicks can feed and move about freely under a protective canopy. Intensive suppression of broad-leaved weeds over extensive areas in western Kansas has sharply limited this cover type and is probably responsible for serious pheasant population decline. Wheat stubble treated with a post-harvest herbicide will receive only a fraction of the pheasant use that untreated stubble will harbor. Pheasant production can, however, be greatly enhanced by leaving a 20-foot, unsprayed strip around field borders.

Something as simple as keeping the combine header as high as possible at wheat harvest (and/or planting taller wheat varieties) can greatly enhance the value of the remaining stubble for pheasants. A few additional inches in stubble height can increase pheasant use several fold. The taller stubble also better prevents wind erosion and catches and holds more snow in winter.

Fall tillage and burning of grain stubbles are highly detrimental to pheasant populations because they leave virtually no valuable habitat during the stressful winter period. These practices also render the soil highly vulnerable to erosion and, in drier areas, will reduce soil moisture storage and subsequent yields.

### *Special Issues*

Pheasant populations will inevitably rise and fall over the years along with mild or severe weather patterns. When

numbers reach low levels, it is common for good-intentioned persons to call for two types of actions which they believe will help the pheasant population recover.

Reducing the hunting season length or bag limit will not effect pheasant population recovery. Since one rooster can successfully mate with many hens, fall roosters-only seasons have virtually no negative effect on spring reproduction even when populations are low. This has been demonstrated through many years of experience through controlled research in Kansas and other states. Following a severe winter in 1968, for example, the state of Minnesota closed pheasant hunting while Iowa kept their traditional 2-month season. Wildlife biologists tracked pheasant populations in counties along their common border and found that pheasant numbers recovered at similar rates in both states.

Supplemental stocking of pen-reared game birds has also been found to be ineffective in bolstering wild populations. Repeated studies throughout North America and Europe have conclusively shown that pen-reared pheasants do not survive well when released into the wild. Because they have had no experience with predator avoidance, most such birds are killed soon after release. Research has shown that about 75 percent of the pen-reared pheasants will be dead within one month of release and only 5 percent may survive to spring. In addition, it has been shown that the few birds that may survive have very poor reproductive success. Concerns exist that pen-reared pheasants may spread diseases to the wild pheasant population. Pen-reared pheasants also attract predators that may continue to focus their attention on pheasants even after the pen-reared birds have been killed. There is abundant evidence that supplemental stocking is of no value and that it only diverts attention away from real habitat needs.

### *Summary*

Pheasants are dependent upon agriculture and are very sensitive to agricultural management. Practices which maintain in close proximity a variety of undisturbed covers that satisfy winter, nesting, and brood-rearing needs will produce a positive response in pheasant numbers. Pesticide use should be minimal. Roosters-only hunting is not detrimental to pheasant populations.

## Questions for Chapter 27

1. What types of cover do pheasants require?
2. What types of food do pheasants eat in Kansas?
3. How can a wheat farmer help his or her pheasant population?
4. Describe the role weather plays in pheasant populations?
5. Does the length of a ??-only hunting season adversely affect pheasants?

Name\_\_\_\_\_



## Chapter 28

# Bobwhite Quail Management

Jeffery D. Sole

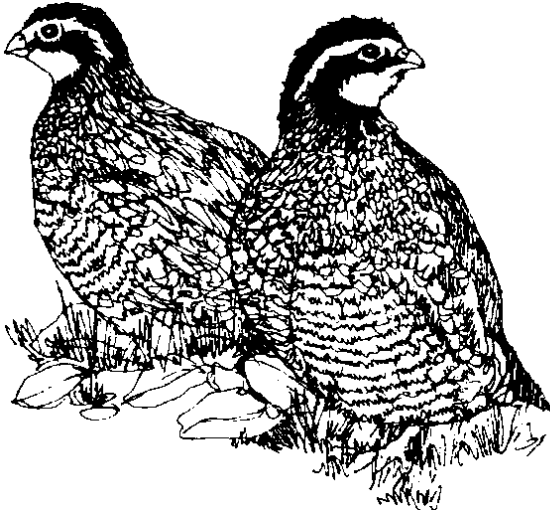

The bobwhite quail is a small gallinaceous, fowl-like bird belonging to the North American quail family (*Odontophoridae*). Bobwhites are approximately 9 to 10 inches long, and they weigh 6 to 7 ounces when fully grown. The birds' coloration is a mixture of chestnut browns, ashy whites, and black and gray patches. Cock birds are distinguished from hens by a white eye stripe extending from the forehead to the back of the neck. The male also has a white throat. The female has buff coloration in the same areas. Sex determination can also be made by listening to the birds' calls. While quail have a variety of calls, the cock bird whistles "bob white" or "ah bob white" (giving rise to its name). Hens have distinctive single-note whistles. These whistles are used to gather the covey together or alert the birds to danger.

## Distribution and Range

The bobwhite developed over hundreds of years as a moist-soil prairie bird. Bobwhites are found in all states east of a line formed by Montana, Idaho, Utah, and Arizona with the exception of North Dakota.

Populations of this popular game bird are most stable in the southern and eastern part of the Great Plains. Bobwhite distribution is controlled by severe winter weather in the north and a lack of sufficient rainfall in the west. Bobwhites have been successfully introduced into Washington, Oregon, Idaho, and Wyoming.

In Kansas, the bobwhite is found throughout the state where suitable habitat exists. Historically, the higher quail populations have been found in the eastern two-thirds of the state.

## Reproduction

The breeding season for bobwhite quail in Kansas begins when coveys break up in late March through April. Male birds establish territories, and their distinctive whistle becomes more frequent through May as the cocks try to attract a mate. After pairing, the female lays one egg per day in the nest until a clutch of 12 to 15 eggs has been deposited. The female begins incubating the eggs after all eggs have been deposited in the nest. The nesting season in Kansas can extend into October. However, quail broods hatched after September 1 are smaller in size, and the young do not survive as well as those born earlier. As high as 60 to 70 percent of bobwhite nesting attempts are lost to various causes. Bobwhite quail will renest.

Both the hen and cock take part in the incubation (23 days) and rearing of young quail. If the hen is lost to predation or disappears for some other reason, the male will continue incubation and raise the chicks by himself. Most of the eggs hatch, and the young leave the nest as soon as their down has dried to begin searching for insects. During the first two weeks of life, the down-covered chicks are susceptible to cold, rainy weather. It is during this period that most chicks die. The chicks grow rapidly, and by the end of their second week the down has been replaced by water-repellent feathers. By 15 weeks of age, the young birds are virtually indistinguishable from adults.

By late October, most chicks are fully grown; however, brood size has been reduced through natural mortality. At this time, a fall shuffle occurs, and broods are joined by unmated males, unsuccessful pairs, or other broods to form a covey. Covey size varies, averaging 12 to 17 birds. Movements of individuals between quail coveys occurs at a rate of one bird gained or lost by a covey every three days. This fall mixing and spring brood breakup helps limit interbreeding.

### Estimating Age and Growth

1 week or less	covered with down, can't fly, downy but may have wing feathers.
2 weeks	sparrow-sized, can fly weakly.
3-4 weeks	size of sparrow and up to almost half grown.
5-7 weeks	flying well, about half-grown.
8-10 weeks	adult size but adult color and pattern undeveloped.
11-13 weeks	adult size, can distinguish sex by examining adult plumage developing on head.
14 weeks and up	appear as adults with clearly defined markings on head. Full growth takes about 15 weeks.
Adults	tiny buffy tips on wing coverts mean birds are under 1 year old. Without buffy tips birds are 1 year or more old.

### Population Dynamics

Long-term bobwhite population trends are controlled by weather and habitat quantity and quality. Bobwhite quail are highly productive given proper habitat and good weather. Population fluctuations can be extreme on a year-to-year basis and are influenced by weather patterns, which affect reproductive success and overwinter survival. Prolonged periods of cool, rainy weather during the time when chicks are hatching can be a cause of high chick mortality. Severe winter weather when snow or ice covers the ground for more than three days can also cause the population to decline. Other sources of mortality include predation by hawks and owls. Relatively few quail are lost to mammalian predators except stray dogs and cats. However, many mammals (skunks, opossums, raccoons, weasels, mink, and rodents) and snakes will readily eat quail eggs. Quail are also lost to a variety of viral, bacterial, and fungal diseases common to domestic poultry.

Bobwhite quail can be considered an annual crop since 70 to 85 percent of the population will die every year. It is a rare bird that lives more than two years in the wild. The quail population is lowest in late March and April when pairing and nesting begins. The population is highest in late July and August just after most of the eggs have hatched.

The high mortality of quail occurs with or without hunting activity. The idea of stockpiling quail on refuges will not work to any large degree. Until recent times, hunting was considered to be completely compensatory in quail populations. Recent information has shown that late-season hunting can contribute to annual quail mortality because it increases pressures on the birds caused by fragmentation and loss of habitat. While numbers of quail hunters remain fairly stable, habitat is being lost at alarming

rates leading to more concentrated hunting efforts and more continual disturbance of the quail.

### General Quail Habitat Management Information Habitat Needs of Bobwhite Quail

In his book, *Beef, Brush and Bobwhites—Quail Management in Cattle Country*, Fred Guthery has an opening two paragraphs which rather sums up how the quail manager must look at habitat. He says:

“Imagine you’re 6 inches tall, weigh 6 ounces and would rather walk than fly. Your view of the world would change. A knee-high shrub would become a small tree, a dense stand of bluestem would become an impassible jungle, a 1-mile jog would telescope into a half marathon.”

“You’re beginning to see through the eyes of a bobwhite. These are delicate, immobile birds that require a variety of habitats. They’re largely concerned with living space from ground level to a height of about 3 feet on areas no larger than 20 city blocks. Therefore, managers must create crazy-quilt patterns of cover on small areas; “patches” in the quilt must fulfill seasonal and annual cover needs.”

The preferred habitat of bobwhites is a mixture of grassland, cropland, brushy areas, and woodland interspersed to provide abundant areas of “edge”—those margins where two or more cover types come together. Grasslands are utilized mainly for nesting cover and brooding, cropland for feeding and dusting, and brushy areas, thickets and woodlands for escape cover, loafing, and winter protection. The bobwhite is dependent upon “edges” where it can move quickly from nest to feeding areas, from food supply to escape cover; where changing from one activity to another is but a matter of a quick walk or flight of a few seconds duration. The greater the interspersed type combinations, the greater the amount of edge and bobwhite quail.

### Characteristics of Specific Cover Needs

#### Nesting Cover

Bobwhites construct their nest on the ground, typically in the protection of a clump of grass that they can walk to, and yet provides some overhead protection. The nest bowl is made from dry vegetation from the previous year’s growth. About 80 percent of quail nests are found within 20 to 25 feet of an edge where habitat types change and which serves as a travel lane for the birds. Most nests are built in a grass clump from 6 to 18 inches tall. Native prairie grasses with their clump-type growth form are ideal nest cover. Prairie grass sites with a clump density of no more than one 12-inch diameter clump per square foot (2 feet × 2 feet area) are the best. This allows for sufficient nesting clumps (about 10,000 per acre) and is thin enough to allow the birds to walk through the cover. Even much thinner nesting cover allows for plenty of nesting clumps and easier travel. In Texas,

biologists consider about 250 nesting clumps per acre to be about the minimum.

### Brood Cover

The greatest mortality of quail occurs in the first four weeks after hatch. This is a critical period which often determines whether the fall population will be a bumper crop or less than desired.

Quail chicks have only a few requirements but these are a must. Chicks need freedom of movement at ground level, overhead concealment, and a diverse assortment of green plants or plant parts within pecking height—which for a baby quail is only about 2 inches. The ground cover must be very open with only 30 to 50 percent vegetative coverage. This means that as much as 70 percent can be bare ground. The low-growing greens attract insects, such as beetles, grasshoppers, leafhoppers, ants and other invertebrates which compose almost the entire diet of quail up to 3 weeks of age. Recently burned prairie units are ideal as are old field sites, weedy strips, legume plantings, and small grain and legume mixes. The brood cover must be near (within 100 yards) of mid-day loafing coverts which is typically woody cover thickets or stands of taller dense weeds.

### Loafing Cover and Winter Protection

Bobwhites require some type of shrubby/woody cover for loafing, headquarters sites, and protection from winter snow and winds. These areas provide a safe, comfortable resting site between morning and evening feeding periods. They will utilize tall grasses and weed patches but prefer woody plants. Many of these sites become what are known as “covey headquarters” which are those select sites around which a covey will center its daily activities. A covey may have several headquarters within its home range that it uses from time to time depending upon the weather and available food. Loafing and headquarters sites may be as small as 100 sq. ft. but ideally are at least 400 square feet or larger. Larger, denser sites are required for protection during extremely cold winter weather. No less than 5 percent nor more than 25 percent of a covey home range should be in woody cover that is 3 to 6 feet tall.

Covey headquarters and loafing sites are easily made by protecting existing thickets from fire or grazing, felling a tree covered with grape or greenbrier vines, or planting small thickets to low growing shrubby species, such as American plum, black berry, fragrant sumac, tartarian honeysuckle, sandhill plum, nanking cherry, or dogwood.

### Winter Food

Bobwhites will utilize numerous kinds of seeds, grains, and berries to satisfy their food requirements. Studies have shown that over 1,000 plants are in the diet. However, there are a relatively few that are of the most importance.

To the manager wanting to maximize quail populations, knowing which seeds provide the most energy to quail is of utmost importance. Raising or encouraging those plants for winter food supply which provide a low calorie food source is not only wasteful but can actually be detrimental to the quail. Quail food habits are almost as much a matter of availability as they are selectivity. Therefore, if a low-quality seed is in abundance, the birds will utilize it. On poor feed, quail will not be as fat and not be able to withstand severe winter weather, hens will enter the breeding season in poorer condition, lay fewer eggs, and experience more physiological stress.

The seeds which contain 80 percent or more of the energy required to maintain a quail in winter are (in decreasing order of importance):

Food Item	Percent of Requirement
Giant ragweed	99.2
Western ragweed	89.1
Corn	88.7
Soybean	86.7
Sorghum	85.1
Sunflower	83.8
Osage orange	81.6
Dogwood	81.2

Having several of the above seeds available to quail within their home range would offer some degree of insurance against crop failure.

In most plans, we will try to maintain one food plot (or feeder station where plots are not feasible) per 40 acres at the maximum density to one per 160 acres at the minimum density. The plots need not be more than 2 to 3 acres and in fact several smaller plots with better distribution would be better. The exception would be those fields managed for doves where larger fields are needed to attract the birds.

### Description of Certain Habitat Management Techniques

A few management techniques will be of utmost importance in developing quail habitat. These include controlled burning, disking, mowing, planting of food plots, legume seeding, shrub and shelterbelt planting, and half cutting. A short discussion of each of these is presented here to better understand each.

### Controlled Burning

Fire is one of the most important quail habitat management tools in our area. Burning performs several vital functions, including removing accumulated litter, stimulating new growth, and controlling excessive woody invasion. Native rangelands that are burned periodically have a wider diversity of plants beneficial to quail than unburned prairies. Also, quail utilization of burned prairies will be greater than

on unburned prairies for four reasons: (1) The litter has been removed from the ground level which aids in bird movement. (2) Burned units attract a greater density and diversity of insects which are critical to quail chicks. (3) Seed production is greater on burned prairies. (4) The ability of birds to feed on those seeds is improved.

Burn when there is a 5 to 15 mph wind, preferably in the stable atmosphere of one day after a storm front has moved through and when the humidity is above 40 percent. Remember that the wind tends to increase in speed throughout the day and generally decreases toward evening.

For best wildlife response, burn in small units. On any area of 40 to 60 acres or larger burn only one-third of the unit annually. Use firebreaks that are maintained by disking or fall mowing. Burning only one-third of the unit annually allows a portion of the area to be in ideal nesting cover, a portion that is good nesting and fair brooding, and an area that regrows to ideal brooding sites.

If control of excessive woody plants is the objective of the burn, then a "hot" fire is best. This is one which, after the backfires are secure, is set to travel with the wind and generate a lot of heat as it consumes the litter. "Cool" fires are most often used by wildlife managers. These are generally fires set to back into the wind or where the line of fire is parallel with the wind. "Cool" fires are easier to control and do a good job of leaving some woody cover intact. "Cool" late afternoon and nighttime burns are very good. The purpose is not generally to completely sweep the entire area black with a fire but rather to enhance the "crazy quilt" pattern. Nighttime fires set when the wind is decreasing and humidity rising tend to go out in some spots and burn through the heavier cover creating a patchwork design.

**Disking and Mowing**

The disk is another relatively inexpensive and effective tool available to the quail manager. Too often quail populations are perennially low in an area simply because birds are not able to move from one habitat to another. Quail **must** be able to walk between their food, cover, and water needs, and if the vegetation is too thick to allow this or there are inadequate travel lanes, the potential population density of quail will be reduced.

Disking also does a couple other beneficial things for quail. If a disked area is allowed to regrow into the annual weeds and grasses that normally invade disturbed soil, there will be additional areas for chicks to catch insects and a winter food supply in the weed seeds. Also, the bare soil areas are needed by quail for dusting sites so the birds can rid themselves of external parasites.

Normally, the strips are disked deep enough to thoroughly disturb the soil and kill existing vegetation. About 3 inch to 4 inch depth is enough. The strips can be in various widths depending upon the equipment used, however about

10 to 15 feet is about the minimum. Strips up to 10 yards wide are fine as long as they are allowed to revegetate to annual weeds and grasses.

In some places, disking will be impossible due to the erosion that might occur on the strip or because of shallow, rocky soils. In either of these instances, mowing can be used as the alternative.

Areas mowed as travel lanes should be cut as short as possible and preferably in the fall. Mowing should be considered only a substitute for disking where disking is not possible, since a mowed strip does not possess many of the beneficial attributes described above the disked strip.

**Food Plots**

Food plots can vary greatly in size but generally from one-fourth to 2 acres is sufficient for bobwhites. On areas where there may be severe competition with other animals, especially deer, the larger food plots will be needed. Where no deer problems are likely to occur, the smaller ones are sufficient. On larger food plots, or even portions of crop fields, managers plant only one-half of the plot annually and allow the remaining portion to grow into summer annuals in the idle years.

Care must be taken that quail are always able to walk through the food plot to gather seeds. If the plot is planted too thick, or becomes choked with weedy grasses, then quail use and food plot effectiveness will be reduced. Use the following seeding rates for the various food plot crops:

Crop	Pounds per acre
Milo (with planter)	4 to 5
Milo (broadcast)	6 to 8
Soybeans (with planter)	30 to 40
Soybeans (broadcast)	50 to 60
Corn (with planter)	12 to 15
Corn (broadcast)	not recommended
Sunflowers (with planter)	2 to 3
Sunflowers (broadcast)	4 to 6
Egyptian wheat (planted)	4 to 5
Egyptian wheat (broadcast)	6 to 8

Some additional food plot crops that have worked well for quail are: buckwheat, sorghum, sudangrass, Rox orange cane, peredovic sunflower, WGF sorghum, bobwhite soybeans ( a reseeding variety of field soybeans), various peas, and cowpeas. All of these should provide high energy winter foods.

Soil samples should be taken for any quail food plot area to determine the fertility and recommended fertilizer rates. Follow the recommended rates for producing a medium milo or corn crop.

Allowing some "weeds" to grow in the food plot is not necessarily bad; however, a thick mat of annual grasses, such as crabgrass or foxtail, will hinder the quail's ability to

forage for seed. At least one cultivation is usually need to get the grain seed plants off to a good start ahead of the weeds and grasses.

### **Legume Seeding**

The seeding of disked strips with wheat or oats and a legume crop is recommended. Legumes are important to the hen in spring when she is gaining physiological condition for nesting. Green legumes also attract a diverse array of insects beneficial to quail chicks.

The legumes most often used by the quail manager are: Korean lespedeza, ladino clover, white clover, red clover, and subterranean clover. All of these can be broadcast seeded in later winter onto bare soil or drilled.

Any strips disked as a fire break or disked as a travel lane for quail or even portions of some of the larger food plots can and should be planted to a legume crop or a small grain and legume mixture.

### **Half Cutting and Shrub Planting**

In many areas the amount of woody cover at “quail level” is deficient or essentially non-existent. Where there are trees that can be used, a lot of half cuttings can be made.

Half cutting of trees means cutting a tree one-half to two-thirds of the way through leaving a hinge of bark attached so that the tree falls over, yet remains alive. Essentially, this creates a living brushpile. This is particularly useful in making covey headquarters. The effect is enhanced if trees can be found which have a vine, such as river grape or greenbrier, attached which will then proceed to cover the entire brushpile. Several trees in one site half cut so that they fall onto each other making a brushpile of from 20 to 50 feet across are particularly effective.

In places where there is no woody cover existing that can be half cut or protected with disking, the manager may have to replant some small shrub thickets. The best shrubs for our area are: American plum, fragrant sumac, autumn olive, red cedar, dogwood, blackberry, multiflora rose, granjeno (spiny hackberry), lote bush (chaparral), black brush, Texas persimmon, and lime pricklyash.

Where no native shrubs exist at a site where a thicket is needed, we have little choice but to plant. Any planting will have to be protected until it is well established from fire and grazing for at least several years. All of the shrubs we plant for these purposes are bare root seedlings. Plantings are made at any time from mid-March to mid-May, however, the earlier the better. Site preparation is very important to the survival of seedlings. Any vegetation that will compete with the seedling’s moisture or nutrients should be killed. If the planting site is currently in cultivation, disking once or twice may be adequate to kill existing competition and prepare a mellow soil. If it is in grass sod, you must plow

the area to be planted. Allow the plowed site to mellow over winter and disk again in the spring to prepare the soil.

Spacing of plants is important. Between-row spacing can be dictated by the equipment used to cultivate (or disk) between the rows; however, the rows or shrubs should be no closer than 8 feet nor more than 12 feet. Spacing within the rows should be 10 feet for red cedar and 5 feet for shrubs.

Care after planting is also very important. The thickets must be protected from livestock. They must also be kept weed and grass free at least for the first year or two by cultivation and/or hoeing or mulching.

### **Root Plowing**

Root plowing or root pruning is proving to be a very cost effective way for crop producers to gain additional income at minimal expense and effort, without sacrificing the benefits that established hedgerows have provided to reduce wind erosion and provide cover for wildlife.

Root plowing is usually done with a heavy-shanked chisel adapted for severing of osage orange tree roots so that they do not reach into adjacent ground to compete with crops for soil moisture. In some situations osage orange roots have sapped the water from the ground and resulted in reduced yields of crops 45 to 75 feet into fields bordered by hedgerows. Root plowing increases yields and allows crops to grow adjacent to the hedgerows. In areas where hedgerows have been bulldozed, many people fear a return of the wind erosion problems of the 1930s. Most hedgerows were planted by landowners who survived the dust bowl days. As a result of these hedgerows, many species of wildlife benefitted.

### **Food Plots**

Often, food is a limiting factor for wildlife populations, especially for resident wildlife populations in the Great Plains during winter and early spring. Winter and early spring are periods when weather can become severe in the Great Plains and is a time when natural food supplies are depleted. During severe weather, wildlife species often experience additional diet stress because snows cover their remaining food supply, and the cold weather requires more food to maintain body heat.

The benefits of food plots have been advocated for many years, but only recently has their benefits been demonstrated scientifically. Field studies at Kansas State University showed that food plots enabled wildlife to maintain higher weights and fat reserves during winter, both of which are related to greater survival of wildlife during harsh periods of winter weather.

When developing a food plot for wildlife, that food plot must be specific in nature, i.e., contain food that will benefit the wildlife species for which it is being developed. The first



step in developing a food plot is to decide what species of wildlife you propose to benefit. Obviously, planting a patch of corn will not directly benefit an insect eating bird, such as a red-headed woodpecker. Nor will planting a strip of milo benefit a worm-eating bird, such as an American robin. Different birds prefer different vegetation for feeding, loafing, etc.

Another often overlooked fact is that all seeds do not contain the same concentration of energy. Wheat and sorghum contain approximately 4.4 kcal of energy per gram, whereas sunflower and ragweed contain 5.7 to 6.0 kcal of energy per gram. That means that there is 30 to 35 percent more energy in sunflower and ragweed seeds than in wheat and sorghum seeds. However, not all the energy in a seed can be digested and utilized by a bird.

**Table 1. Metabolizable energy in seeds of plants commonly used for food plots for seed-eating birds.**

Seed	Metabolizable Energy Content (kcal/g)
Giant ragweed	4.32
Western ragweed	3.88
Corn	3.87
Soybean	3.78
Sunflower	3.65
Sorghum	3.59
Dogwood	3.54
German millet	3.47
Prostate lespedeza	3.42
Korean lespedeza	3.14
Wheat	3.06
Thistle	2.70
Shrub lespedeza	2.69
Black locust	2.53
Partridgepea	2.42
Smartweed	2.30
Multiflora rose hips	2.02
Switchgrass	1.86
Smooth sumac	1.48

From Robel et al, 1974 and 1979.

Research on bobwhites at Kansas State University disclosed a wide variation in the amount of energy contained in a seed that is useable by bobwhites. For example, bobwhites can utilize between 82 and 86 percent of the energy in sorghum, 54 to 63 percent of the energy in lespedeza seeds, and only 26 to 30 percent of the energy in seeds of smooth sumac. As with the bobwhite, non-game birds cannot digest all the energy in a weed. Cardinals can use 85 percent of the 6.9 kcal/g of energy in sunflower seeds but only 54 percent of the 4.9 kcal/g of energy in lespedeza. Obviously, a food plot providing sunflower seeds for

cardinals would be better than one providing equal amounts of lespedeza seeds. In fact, the sunflower patch would be over twice as good as the lespedeza patch for cardinals.

Table 1 provides information on the amount of metabolizable energy in some common seeds. These were determined for bobwhites but most likely are applicable, in general, to other upland game and nongame birds as well. When selecting plants for food plots, it is better to pick the ones that provide the higher amounts of energy.

*How many food plots are needed?* As a rule, one food plot for every forty acres of farmland would be a minimum. On farms where cultivated crops are grown, fewer food plots would be necessary if crop residue and some grain is left standing. More food plots would be required on a pasture farm where no grain is grown, however.

*Location and protection.* Livestock **must** be excluded if the food plot is to be of any value to wildlife. (**Caution:** After frost or drought, some plants in the mixture are poisonous to livestock). If an ungrazed area is not available, locate the patch so that it can be fenced with minimum expense.

The food plots must be located where wildlife using it will have escape cover close by. Good locations will be next to brushy draws, corners of shrubby fencerows, edges of wooded areas, odd areas not used for agricultural purposes, and along travel lanes large enough to afford cover. Heavy cover, such as brushpiles, can be added next to the fenced-in area. There should be around six brush piles of at least 15 feet in diameter per quarter acre plot.

*Size of the food plot.* The minimum size is one acre. Anything less than this will not provide enough grain for the long winter months and likely be destroyed by deer.

Ideally, a 2-acre area is set aside for the food plot. Each year, plant half of this (1 acre). The following year, plant the other half and allow the first half to grow annual weeds. This rotation will provide native seeds, bare ground for dusting, standing grain for food, and make better use of the fertilizer.

The following measurements will aid in laying out the quarter-acre plot. (Double one figure for roughly one-half acre).

Width	Length	Width	Length
20 ×	550	50 ×	220
30 ×	365	75 ×	150
40 ×	275	105 ×	105

Note: For field corner plot, measure along each axis 150 feet and connect the two points.

The shape of the plot is not important. An irregular shape with “islands” of cover is excellent.

*Seed mixture.* A mixture of grain will provide desirable plant diversity, but competition may reduce the total seed production. If only one grain is to be planted, milo will give the best results. Four pounds of milo per ¼ acre plot should be sufficient.

The seed mixture proved most suitable state-wide, is:

Milo	2 pounds
Soybeans (Clark)	2 pounds
German millet	1 pound

Over-seeding will increase competition between plants and cause “damp-off” of the milo. The result of sowing too much will be a reduction in the amount of grain at maturity.

*Fertilizer, lime, seedbed, and planting time.* To determine the exact nutrient requirements, a soil sample can be analyzed by Kansas State University through the County Extension office. The results will show what is required for good seed production.

After these important steps are complete, then drill or broadcast the seed mixture and cover lightly (the seed can be covered by dragging a large shrub or cedar tree over the plot behind the tractor).

Planting time for most of Kansas will be between May 10 and June 20. Remember, the objective of an annual food plot is to supply emergency food next to heavy cover for use when native foods are covered by ice and snow. The food plot will not supply enough feed if other native seed producing plants are in short supply. The annual food plot is just one important “tool” in an overall wildlife habitat management program. If stable populations of wildlife are desired, the only sound approach will be a planned habitat management program that is applied over a long period of time.

### Hunting Considerations

A quail hunter can help ensure the quality of this sport by taking care of the breeding stock. The sportsman’s rules of shooting only two birds per covey find and leaving six or seven birds per covey are helpful in this respect. But these constraints lose their effectiveness late in the hunting season when small groups join into a “bevy” appearing as a newly found, large covey. Another complication is the unfortunate tendency to put in more hunting hours to attain bag limits in poor years when the best thing to do might be to slack off. At such times, it is advisable to even out the pressure by spending more time on those areas with the greatest number of birds. These sorts of adjustments determine the stock for launching next year’s bird crop.

It is commonly thought that quail tend to take care of themselves when it comes to the amount of hunting pressure they will stand. Every bird hunter knows that coveys hunted more than about once a week will heighten their evasive action, run great distances on the ground, flush wild, and seek shelter in dense thickets. This behavior does tend to limit the number of birds harvested to some extent, especially where birds have become attuned to scheduled, moderate shooting pressure involving all-terrain vehicles or horseback riding. It is by concerted hunting on foot with persistent shingles shooting that quail will most likely be shot down below the tolerance level of the population.

The best way to adjust the harvest is to use a population estimate taken just before the hunting season opens. The commonly accepted principle of harvesting a sustained annual surplus does not readily apply to quail. Their numbers fluctuate so greatly from year to year that the potential surplus varies widely. A fairly accurate census method is to get several people in a row, about 20 yards between individuals, and walk over a known acreage of the hunting range. The sample area is covered in swaths, each with its borderline slightly overlapping that of the adjacent swath. All quail are recorded as they flush and are watched until they land to make sure they are not counted again. It is best to repeat the total count on at least three different days and take an average. Research has shown that about 50 percent of the birds are typically found in this manner. Thus, the actual number in the sample area is estimated by doubling the average quail count. This sample number projected out for the whole hunting area gives the population estimate.

Another method involves the use of bird dogs. Without any shooting, a sample area is traversed thoroughly with braces of dogs in the normal hunting fashion. All quail are counted only once. Again, the process is repeated on at least three different days. According to a research study, bird dogs find on the average about 40 percent of the birds actually there, so the sample area number is calculated by multiplying the average flush count by 2.5. This number is expanded as before to estimate the population for the whole hunting range. While being more enjoyable, the bird dog census is highly variable and not as reliable as the walking census due to scenting conditions of quality of dogs.

A ball park number of huntable birds is essential if one is serious about not shooting more quail than a wild population can bear. To illustrate this, we will consider an example of 100 quail at the beginning of the hunting season (Table 2). The harvest is initially set at about 30 percent, including birds that are bagged or downed but unretrieved. The percent loss to predation and chick production are calculated from figures determined during field studies at Tall Timbers. After the 30 percent harvest and the loss to predation, the remaining adults with their new chicks bring the population level back to its initial level.

If hunting pressure was to be increased to a harvest level of 45 percent with all other factors remaining the same, the population the following fall would drop to about 70 birds. But, of course, predation and birth rates do not remain constant over the years; both factors vary yearly with weather conditions and the number of predators and the small animals on which they prey. The acceptable percentage available for harvest probably also varies from one management area to the next because of site/habitat quality, so it is necessary for a manager to keep good harvest records to develop a feel for that percentage on his area. In any case, it is always best to plan for a poor reproductive season by leaving a few extra

breeders. For the sake of future hunting quality, sometimes two birds in the hand are worth far less than one in the bush.

**Table 2. Changes in a theoretical quail population due to hunting, predation, and reproduction.**

	Number of Birds	
	Males	Females
Fall population	52	48
Hunting	-15	-14
Predation (fall-spring)	-16	-15
Residual birds	21	19
Predation (breeding season)	-4	-5
Residual birds	17	14
Chicks born	80	80
Subtotal	97	94
Chick mortality (first month)	-40	-40
Residual birds	57	54
Predation until fall	-6	-5
Next fall's population	51	49

### Pen-Reared Birds

Releasing pen-reared stock has been used to provide additional birds where the natural carrying capacity is too low for the desired hunting pressure. This practice has a useful place, particularly on small landholdings or on corporate hunting preserves that cater to a large number of guests. Pen-reared stock is also often used as an aid in training bird dogs.

A number of strategies have been tried in releasing birds: (1) immediately prior to the hunt, (2) several weeks before the hunting season in an attempt to condition birds to behave more naturally, (3) during the spring to add to the wild breeding stock, and so forth. Practically everyone who is either engaged in releasing or in selling quail has a slightly different approach. These techniques range from elaborate setups involving call-back birds, waterers, and feeders to simply releasing the birds in available cover. It is impractical to try to research the effectiveness of all these methods. Many individuals believe that the release of young quail (6 to 12 weeks) results in greater survival because the birds have not been domesticated as long as their adult counterparts. Others believe that the age difference at release cannot compensate for the many generations of inherent domestication.

Tall Timbers has recently completed two studies on the fate of released birds. The first involved the spring release of 28 pen-reared hens to see if they would select wild mates, nest, and rear young. An equal number of wild hens was studied for comparison. Through radiotelemetry, it was learned that the domesticated hens survived from two to 50 days, with the average being 11 days. None of these hens was known to have nested, and no broods resulted. Since all

released females were seen with wild males, a potential competition for wild mates might have occurred between domesticated and wild hens. Only four of the 28 wild hens in this project were killed. The remaining 24 hatched out 145 chicks during the study period. Most of the pen-reared hens (61 percent) were killed on the ground by mammals while birds of prey accounted for most of the few wild quail killed.

The second experiment was to determine harvest rates and movements of fall-released quail. Several thousand pen-reared birds were released two and one-half months prior to the hunting season. All birds were banded, and their release and kill locations recorded on aerial photographs. By the end of a very rigorous hunting season, only 18 percent of the released birds were harvested. However, this represented over half of the total birds taken during the hunts. Less than one percent of the birds released in the first year of study were harvested the following fall, suggesting that year-to-year survival was extremely low. These findings are similar to an earlier report involving the restocking of 159,000 birds, of which only 1.2 percent survived for a year.

There is much work needed in preconditioning birds prior to release. Long flight pens are not all that is necessary because caged birds rarely utilize these pens for exercise unless they are harassed. The combination of flight pens and total isolation from human activity has promise since fear of man and his canine hunting partner produces the wildest bird.

The importance of using disease-free stock cannot be overemphasized because pen-reared quail are potential reservoirs for several contagious diseases. For example, they may serve as reservoirs for blackhead, a serious disease affecting wild turkeys. Particular care should be taken to vaccinate the birds against pox. Otherwise, sick birds may be turned loose and possibly infect wild quail and spread diseases to neighboring populations. Most states have poultry diagnostic labs that can check a sample of birds prior to release, and many areas have a poultry extension agent who can recommend treatment if necessary.

### Where We Are Today

When the Europeans first explored the eastern United States, bobwhites were not very abundant. Bobwhite quail habitat improved and expanded as the forests were cleared and family farms were established. Quail populations expanded and benefited as the settlers began establishing agricultural crops and creating early plant successional habitats (typical of the pioneer homestead farm). As more land was cleared and settled, bobwhite habitat continued to improve throughout the 1700s, 1800s, and early 1900s. Not until the advent of mechanized farming and the initiation of clean-farming practices, in the mid-1900s, did the quantity and quality of quail habitat begin declining in Kansas and elsewhere. As machines took the place of the horse and

mule, farm wildlife habitat quickly began to disappear.

Quail habitat and populations began to suffer in the 1930s. Historical records from this period suggest attempts were made to increase quail populations through pen-reared quail-stocking programs. World War II interrupted these stocking efforts. Immediately following the war, many states including Kansas, began massive quail-rearing and stocking programs. By the late 1940s, wildlife professionals noticed quail populations were not increasing in response to the stocking programs. Many states, including Kansas, began research studies to determine why populations were not increasing, and the results showed the futility in trying to improve wild quail populations by stocking pen-reared birds.

Most states abandoned the idea of stocking game farm birds during the late 1940s, and programs began to favor habitat restoration programs. Programs emphasized creating habitat, such as brushy fencerows and winter food plots, by supplying landowners with planting materials.

As the 1950s progressed, many farms were abandoned as people moved to towns and cities to become factory workers. Much of this abandoned farm land became ideal quail habitat. In the early 1960s, the federal government started a land retirement program called Soil Bank. This program allowed some weedy, brushy cover to return to land which was no longer farmed. Thus, quail habitat and populations improved in the 1950s and 1960s.

As the mid- to late 1970s rolled around, the Soil Bank program had run its course. Crop prices skyrocketed, and federal subsidies promoted the creation of surplus crops. Pesticide usage increased during this period. This caused tremendous losses in many wildlife resources before the cause was identified. At this time, quail suffered tremendously from some of the commonly used pesticides. Current studies are indicating pesticide usage is still playing a role in quail population dynamics.

During the 1960s, farming in Kansas was transformed to an industrialized business dramatically changing the

landscape. Crop fields became huge, fencerow habitat was destroyed, and every inch of ground possible was put under the plow. This trend in habitat loss continued until the mid-1980s when another federal land retirement program, Conservation Reserve Program (CRP) of the 1985 Food Security Act, was begun. Lowered crop prices and the CRP have curtailed habitat losses at the present time in Kansas and will likely cause temporary gains in quail habitat. Lands enrolled in the CRP are being planted predominantly to native grasses. This will likely lead to better quantity and quality of quail habitat in the state than currently exists.

The farming industry plays the most important role in maintaining the quantity and quality of bobwhite habitat in the state. Generally speaking, modern agriculture has had detrimental effects on bobwhite quail habitat due to the intensification of farming practices. In recent years, farming has become industrialized as farms became larger and family farms disappear. Farming shifted from small-scale agriculture in which small equipment was used to plant a variety of crops in small fields with numerous brushy hedgerows on a specific rotation schedule. It shifted to large-scale conglomerate operations using large equipment to farm large fields of one crop for economic reasons. Fall plowing leaves less waste grain for winter food used by quail. These changes have drastically reduced the amount of bobwhite quail habitat in the state. In addition, the wide-spread conversion of pastures and haylands from native grasses to tame grasses has been devastating for bobwhite quail because the growth form is much too thick and dense for quail to use.

Another land-use change affecting quail habitat in Kansas is urban sprawl. This type of change eliminates suitable habitat through the construction of housing developments, shopping centers, and roadways. This problem is most noticeable near the larger Kansas towns and will likely become worse in the coming years as the human population continues to grow.



## Questions for Chapter 28

1. What are the general habitat requirements of northern bobwhites?
2. What are the specific cover types required by northern bobwhites?
3. What are headquarters areas and why are they important for northern bobwhites?
4. Why is it not a good idea to stock pen-reared quail or establish quail refuges in an attempt to stockpile northern bobwhites?
5. How can farming affect bobwhite quail habitat in the future?

Name \_\_\_\_\_



## Chapter 29

# Greater Prairie Chicken Management

Gerry Horak

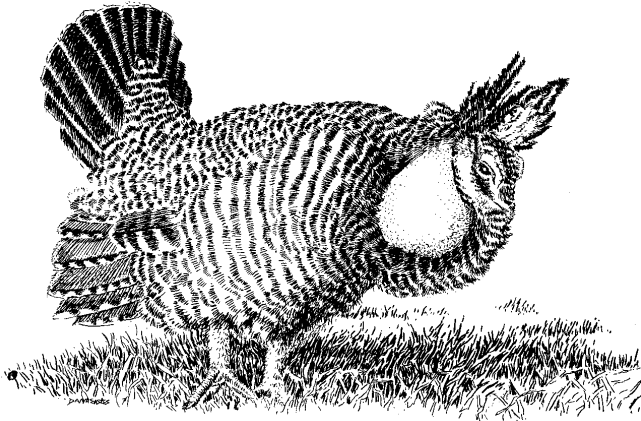

**G**reater Prairie Chickens are a species that “make a living” within a grassland prairie ecotone. Grassland-cropland interspersions of 75/25 proportions provide optimum habitat. Prairie chickens will survive in areas of less than 50/50 interspersions (grassland/crop) or in blocks of total grassland, if the grass in these areas is properly managed. In Kansas, greater prairie chickens inhabit diverse areas from the mid-grass prairie found in the north central part of the state to the seeded tame grass areas in the southeast, but their “stronghold” is the native tallgrass prairies of the Flint Hills. Our studies have shown that prairie chickens are adaptable and can be managed by furnishing a life form of grassland vegetation that provides for their requirements. To fulfill these conditions, the wildlife manager must adopt or encourage the use of grassland management practices that provide optimum grass for “chicken” populations, yet are compatible with a productive livestock operation. Tools used by the grasslands manager (burning and grazing) are simple, inexpensive, and adaptable to good prairie chicken as well as livestock management.

This chapter spells out what prairie chickens require during their life functions. Managers should review these habitat management practices and manage accordingly. Prairie chickens will use most habitat niches in a grazed tallgrass prairie—from lightly grazed areas for nesting to overgrazed areas for booming grounds. Proper proportion and interspersions of grazing pressure is the goal of the manager. Grassland areas in which prairie chickens can walk through, see over, hide in, and feed from will provide the necessary requirements to perpetuate their populations.

## Booming Grounds

Preferred booming ground sites (leks) are located on elevated, droughty, short-grass land, such as hilltops or ridges, often the tallest point for at least one-fourth mile. Grounds can be found on level land or even land lower than nearby terrain if surrounding nesting habitat is suitable.

Vegetation on the booming ground is short and sparse (less than 2 inches tall). Grounds can be an overgrazed hilltop, salt lick, trail, rocky shallow ridge, or cultivated land. Wheat fields are used as booming grounds, but “chickens” abandon these grounds late in the mating season due to the rank growth of wheat.

Booming grounds are typically two to five acres in size and are used perennially. Permanent booming grounds can be economically established by developing a salt lick along a ridge. Cattle coming to the salt lick trample and overuse the vegetation. In addition, the salt leaches into the soil permanently killing any vegetation. Prairie chicken activity on stable booming grounds occurs during all but two months of the year (July and August); thus, maintaining the ground year-round is important. Ideally, booming grounds are best located in areas where at least 60 percent of the habitat is pastureland. This grassland should be in good to excellent range condition (Table 1) and no less than one-half section in size. In rangeland habitat, booming grounds normally are no closer than one-half mile apart.

If grassland is limited, booming grounds can be established on plowed fields. However, at least 80 acres of nesting cover in well-managed pastureland must be within one-quarter mile. When rangeland is limited and interspersed with cropland, booming grounds may occur as close as one-quarter mile apart. With the diversification of grassland management and crop rotation on these grassland/cropland areas, the number and location of booming grounds are less stable and often move as the habitat changes. If pastures are overgrazed or otherwise mismanaged, booming grounds and prairie chicken populations will decline and eventually disappear.

During the spring mating season, a drastic change in habitat may occur because of burning. Burning has little effect on the displaying males but may cause females to shift to other grounds near unburned grassland that provides suitable nesting habitat. Burning is necessary to maintain a tallgrass prairie but should be done only every three to four years on a rotation basis; that is, burning from one-third to one-quarter of an area annually. Generally, burning for best



range management conditions occurs after mid-April about the same time as nest initiation. This will cause some nest losses, but hens will re-nest. If pasture burning is rotated annually, suitable habitat will be available for subsequent nesting. In the long run, this type of burning will benefit prairie chicken populations.

Observations of prairie chicken booming and mating behavior can easily be obtained during the spring. About any type of blind that conceals one's movements can be established. One should keep in mind that blinds will attract cattle thus interfering with the prairie chickens. Ideally, blinds should be in pastures without cattle. Pastures containing steers will work well because steers are usually not in the pastures until mid-May.

### ***Booming Ground Census***

Counts of displaying males on a booming ground are not a reliable index to prairie chicken populations. Numbers of males using a booming ground vary considerably during the April survey period (peak booming activity). Wide variation also occurs in the number of males using a ground during any given morning. Variations are a result of non-territorial males visiting these grounds since the number of males occupying territories often will not vary from year to year. During years of high population densities, the number of non-territorial males will reflect this increase. Trying to establish territories, these non-territorial cocks utilize numerous grounds; thus, on a given morning, a non-territorial bird might visit more than one ground. This movement accounts for the significant variation in the number of males using a ground during any specific period. When populations of non-territorial males are high and they are continually harassed off permanent booming grounds, these males often establish a satellite temporary ground and set up their own territories. These grounds are established later than normal and used sporadically during the booming season. Large fluctuations in the number of males using these grounds are common. When populations decrease, these temporary ground disappear. Non-territorial male disturbance on permanent grounds decreases as the population continues to decline. A natural population low occurs when grounds are occupied by only territorial males on permanent grounds. If the number of males continue to decline and permanent grounds disappear, the population is dwindling because of adverse land-use changes and not due to natural population fluctuations.

Booming ground counts provide an index to prairie chicken populations, not necessarily a percent change from year to year but rather an indicator of an increasing, decreasing or static population over a period of years. Survey areas should be at least 5,000 acres in size with counts conducted in mid-March through April from one-half hour before to one-half after sunrise. Variations in the

number of booming grounds over the years furnish an indication of population trends. An increase in the number of grounds reflects an increase in population, whereas a decrease in the number of booming grounds denotes a population decline. Healthy populations are indicated when the number of males on established grounds show seasonally or yearly fluctuations but no long-term decrease.

### ***Nesting***

When managing large expanses of rangeland, such as the Flint Hills, allowing prime nesting habitat to occupy approximately 15 percent of the area provides optimum conditions for prairie chickens. A minimum of 80 acres of this nesting habitat should be within one-quarter mile of a booming ground. Nesting habitat should be scattered throughout pastures of good to excellent range condition. This contrast between sparse vegetation on booming grounds and heavy vegetation needed for nesting is the extreme in vegetative density utilized by the prairie chicken.

Nest initiation occurs during the height of courtship activities in mid-April. After egg laying and incubation, the young hatch during the last of May or early June.

Nests are usually located on north and east facing slopes of well-drained terrain generally having less than 20 percent slope. Visible changes in habitat, such as trails, fencerows, or vegetation differences, may have nests located nearby. Nests are constructed on the edge of heavy cover. This allows adults to move easily to and from the nest and permits young to quickly leave the vicinity of the nest after hatching.

When nesting begins in mid-April, the dry vegetation from the previous growing season must be available for nest construction. However, there is an upper limit of accumulated duff that will be tolerated by prairie chickens searching for nest sites. In well-managed pastures this limit is usually reached after four or five growing seasons. Again, this points out the importance of burning every three to four years. Nests are built in either natural ground depressions or depressions scratched out by the hen. Fine grass material placed in these depressions completes the nest. Surrounding vegetation must be tall and dense to provide hen concealment from ground and avian predators. Preferred height of nesting vegetation is about 15 inches, but nests have been found in grass as short as 4 inches and as tall as 38 inches.

Nests are found in a wide variety of vegetative types from wheat and alfalfa fields to both cool and warm season grasses. The main ingredient is that a hen must be able to easily move on and off the nest and lead her young from the area soon after hatching. The species of vegetation is not as important as the life form it produces.

To provide prime nesting conditions, two management techniques should be implemented: (1) moderate to light grazing will maintain the proper height and density of

vegetation plus create edge; and (2) prairie chickens prefer nesting cover created when grassland is burned only every three to four years. If occasional burning is not done on moderately grazed pastures, the previous seasons' growth will reach a density discouraging hen use.

A good technique would be to control burn only a third of the range every year. Because of cattle preference for recently burned areas, entire grazing units should be burned. Burning large pastures often leaves a number of unburned areas. These areas are usually of low quality for nest sites, although hens may utilize them for lack of better areas. If these "islands" of grass are small, predators concentrate their feeding activity in them. In large grazing units where a complete burn occurs, prairie chicken populations will adversely be affected due to the complete lack of nesting habitat. These situations could be altered by back-firing potential nesting habitat (at least 80-acre blocks) located in the vicinity of booming grounds.

Quality of nesting cover is of primary importance; however, the quantity and dispersion of this cover is also important. When the quality and quantity of habitat is limited by intensive agricultural use, overgrazing, or extensive annual burning, nesting hens will concentrate in smaller areas. Due to this overcrowding, they become susceptible to increased predation and nest desertion. The end result is lower production and reduced population levels.

Weather plays an important role in annual nesting success. Heavy rains and cool weather in the spring cause nest destruction and desertion. Of course, weather is the one element that cannot be controlled; but knowledge of its affects can help explain population increases or decreases.

### **Broods**

Prairie chicken brood habitat is the grassland niche between the short grass of the booming ground and the heavy cover of nest sites.

After hatching, the hen and young leave the vicinity of the nest as soon as the young are dry. Hens move their brood to vegetation sufficiently sparse for the young to easily move about but dense enough to provide shelter from the hot summer sun. Broods utilize a diverse habitat for their life functions. During the cooler part of the day, young prefer open areas such as trails, overgrazed areas, and cattle rubs; but they stay close to taller vegetation for escape cover. These grassland areas of over-utilization allow easy movements and keep the young out of early morning and evening dew. During mid-day, forbs provide an overhead canopy that shades out grass growth and direct sunlight creating ideal habitat for broods. In large pastures, shallow range sites, where soils are poor and the substrate favors short forb growth with minimal grass cover, are preferred brood habitat. Forb-grass habitats also provide numerous

niches for high insect populations—the primary food of young prairie chickens.

Young prefer habitat created by moderate grazing of pastures in good condition. This provides the necessary brood habitat because of plant diversity, livestock paths, and small areas of reduced sparse cover permitting easy movement of birds. This variability also encourages higher insect populations. Burning every three to four years is a necessary management tool for maintenance of brood habitat on this type of range.

In cropland/grassland areas, broods will use the grassland and cropland borders. Edges of row crops, alfalfa fields, or go-back lands can provide excellent prairie chicken brood habitat. Good insect populations and overhead vegetative canopy with little residual ground cover are the benefits of these fields. Cool-season pastures are used if they offer a life form of grasses and forbs that allow easy brood movement and provide protective cover.

Weather conditions are important both directly and indirectly to young prairie chickens. If heavy rains occur in May and June, many young "chickens" drown or die of pneumonia. Weather affects habitat conditions thus affecting the young. A wet and cool spring and summer will adversely affect the prairie chicken population. In contrast, a dry and warm spring and summer will have a positive effect on populations.

### **Fall and Winter Habitat**

Good nesting and brood cover (rangeland with light to moderate grazing) also serve as the habitat for fall and winter activities. Generally, prairie chickens utilize rangeland habitat consisting of clump-type grasses which provide areas of sparse vegetation surrounded by taller grasses. This habitat, if at least 6 inches tall, provides vegetation easy to walk through and dense and high enough for concealment.

Roosting areas must be extensive enough to accommodate entire flocks. When a flock moves to a roost site, individuals locate acceptable roost spots several feet from other birds. Flocks will locate a roosting site then use this area every night but will leave and relocate if disturbed.

Daytime loafing areas are not as confining as night roosts. Habitat needs will vary depending on weather conditions. On cold, windy days heavier cover is utilized while on warmer days thinner, shorter cover is used. Loafing sites often change from day to day because prairie chickens move around searching out food items like green grass, forb seeds, and available insects. In normal winters, prairie chickens can survive in open rangeland. However, during times of extended periods of snow cover and cold temperatures, agricultural feed fields are necessary as a supplementary food source.

Providing feed fields for prairie chickens is an important management tool. These fields serve as a readily available

**Table 1. Rangeland classification key.**

Condition Class	Characteristics	Decreasers	Increasesers	Invaders
Excellent	Decreases in reproducing stands Plants in healthy condition Increasesers not conspicuous	Big bluestem Little bluestem Indiangrass Prairie cordgrass	Switchgrass Sideoats grama Tall Dropseed Blue grama	Tumblegrass Windmill grass Foxtail barley Common pricklypear
Good	Decreasers conspicuous Decreasers capable of recovery Invaders reproducing markedly	Easter gamagrass Canada wildrye Perennial sunflowers Blacksamson	Hairy grama Buffalo grass Western wheatgrass Rosette panicums	Prairie three awn Kentucky bluegrass Broom sedge Gumweed
Fair	Decreasers not conspicuous Annuals conspicuous Increasesers established	Prairie clovers Compass plant Sensitive briar Wholeleaf rosinweed	Purple lovegrass Rock muhly Sedge spp. Pricklypear	Osage orange
Poor	Decreasers absent Invaders established Forage plants nearly absent Increasesers nearly absent	Roundhead lespedeza Pitcher Sage Tall gayfeather Tickclover Illinois bundleflower Leadplant New Jersey tea Prairie rose	Baldwin ironweed Slimflower scurfpea Goldenrod Wild indigo Western ragweed Parthenium Willowleaf sunflower Aromatic sumac Buckbrush Smooth sumac Gray dogwood Blackjack oak Post oak	

source of high-protein foods, and prairie chickens traditionally have used these fields. This traditional feeding starts in October and continues into March. Although field feeding activity is sporadic and may not occur daily, it is generally more consistent during the fall and winter with birds normally coming to feed fields in early morning and late afternoon. During the hunting season, hunters take advantage of this movement and pass shoot birds as they fly to feed. Jump shooting can be effective in September, but as fall progresses, flock size increases making it difficult to get within range for jump shooting. After September, pass shooting is the primary prairie chicken hunting method.

Ideally, feed fields should be in open areas with a minimum size of 15 acres. Large fields containing a variety of row crops with strips of wheat will get the most use. Favored grain of prairie chickens is soybeans with corn and sorghum also highly preferred. Wheat fields are also used for food during the fall and winter, providing a source of green vegetation. Feeding areas should be close to large pastures to provide good loafing and roosting areas.

### Summary

In grassland areas, height, density, and diversity of vegetation is extremely important in determining quality of prairie chicken habitat. Optimum prairie chicken habitat should consist of the following:

1. Grassland/cropland and interspersed of 75/25.
2. Large pastures moderately grazed providing areas of differential grazing intensity.
3. Controlled burning every three to four years is important to maintaining pastures in a desired habitat condition. This retards invasion of woody vegetation, removes accumulated duff, and maintains prairie plant vigor.
4. Booming grounds (10 percent of area) should be overgrazed providing a turf-like area. Vegetation should not be over 2 inches tall.
5. Nesting sites (15 percent of area) are associated with tall plants in pasture areas that are lightly grazed. Preferred vegetation height is 15 inches.
6. Summer brood and winter loafing and roosting sites on areas (75 percent of area) should be moderately grazed leaving medium to tall vegetation.
7. Feed fields (minimum 15 acres) of soybeans, sorghum, or corn will furnish acreage for winter feed and provide areas for hunter harvest. Green winter wheat is also utilized.

## Questions for Chapter 29

1. What types of cover do prairie chickens require?
2. What types of food do prairie chickens eat in Kansas?
3. Why is burning a necessary management tool?
4. Describe the role weather plays in prairie chicken populations.
5. Describe how booming grounds can be developed.

Name \_\_\_\_\_



## Chapter 30

# Mourning Dove Management

Jeffery D. Sole



Mourning doves are the most abundant game bird in the United States, with annual estimated fall populations of 500 million birds. They are prized by hunters because of their swift and erratic flight patterns. Nature lovers also enjoy the soft “cooing” sounds doves make. Mourning doves are protected as song birds in some northern states.

## What Makes a Mourning Dove a Mourning Dove

The mourning dove (*Zenaida macourea*) (also called a turtle dove, wild pigeon, or Carolina dove) belongs to the pigeon family (*Columbidae*). This fist-sized bird averages 12 inches in length with a 12-inch wingspan. The average mourning dove weighs 4 to 6 ounces. The bird’s coloration is a mottled mixture of gray and buff-brown with black spots and white feather tips. The male differs from the female by having: (1) a bluish cast on the back of the neck and top of the head, (2) a rosier colored breast, and (3) a tail edged with black and broken by white spots (best seen when the bird is in flight). It is aerodynamically designed for fast action with its slightly backswept wings and long, pointed tail.

## Distribution and Range

Mourning doves are forest-edge birds tied closely to agricultural practices for food. Thus, the distribution of doves is limited only in areas where annual grain production is limited by climate. Mourning doves are migratory birds. They breed in all the lower 48 states, Canada, and Mexico. Breeding densities in Kansas usually rank among the top three in the nation. Northern birds

migrate south and spend the winter in Gulf Coast states and Mexico.

All areas across Kansas have good breeding and migratory dove populations. Some doves spend the winter in Kansas, and many portions of the state have excellent dove hunting when the migrating birds take advantage of the agricultural activities throughout the state.

## Cover, Food, Water, and Space Needs

### Cover

The doves’ cover requirements are really quite simple because they are an “edge species.” All their life requirements can be met in a variety of habitats, including pastures, haylands, croplands, or idle areas, if these habitats have scattered woodlands or large trees and shrubs. Feeding areas with abundant seed supplies on bare or nearly bare ground are the prime requisite for having doves in an area. Doves also need perching sites (dead trees, fences, or power lines) for loafing and resting. Doves like to roost in thick, darkened cover, and favored roosting habitat is in evergreens or heavy brush or on the ground in shrubby fields. These cover areas should be at least one-quarter acre in size and located close to available food.

Doves prefer to nest 10 to 25 feet above ground in trees or shrubs; however, doves will also nest on the ground. Evergreens are especially favored nesting sites. Doves select nest sites in limb forks, horizontal limbs, and diverging twigs where:

- *there is level support* (needed for stability for the nest);
- *the nest is close to exposed perches* (needed for territorial advertisements); *and*
- *there are open areas* (needed for courtship).

Doves like nesting along stream borders or at junctions between forest types.

### Food and Water

Doves are opportunistic feeders, and more than 300 plant foods have been identified in their diet. Doves are essentially ground feeders, and their diet consists almost entirely of seeds (primarily from annual grain crops or their associated annual weeds). Some of the most important cultivated dove foods include corn, wheat, grain sorghums, sunflowers, and a variety of millets. Wild plants, such as doveweeds, panic grasses, pigweeds, ragweeds, spurges, and foxtails, produce an abundance of dove food. These

plants usually volunteer when the ground has been disturbed by plowing, disking, or dozing.

Doves tend to congregate where food sources are abundant. Their primary needs are bare soils to feed from and plenty of waste grain or weed seeds to feed on. In Kansas, food sources are plentiful. Corn, milo or sorghum, wheat, sunflowers, and millet are common agricultural crops that tend to attract doves.

Doves require little or no cover (bare ground) for feeding because they cannot scratch the ground like quail and grouse. They cannot scratch through grass or vegetation and must pick food up off the ground. This ties the birds closely to agricultural landscapes in most cases.

Doves also eat tiny amounts of snails and insect parts or other animal matter as a source of calcium. Doves must have grit for grinding the grain and weed seeds they eat. They obtain grit in daily visits to roadsides or other areas where small gravel or sand is abundant. Young doves do not eat solid foods but are fed a regurgitated substance called "pigeon milk" by the adults. This substance is produced from glands in the crops of male and female birds.

Mourning doves require water for bathing and drinking. Doves and pigeons are unique among birds because they drink by suction without raising their head. Other birds must take a beakful of water and tilt their head back to swallow it. Doves usually need water after feeding in the morning and evening.

Doves will travel a considerable distance to obtain water but can survive for up to five days without it. Doves prefer standing or stagnant water to streams. They seldom use water holes where tall grass or weeds come to the water's edge. Farm ponds with vegetation-free banks and scattered trees are the best watering holes for doves. Having a water source near food, nesting, and roosting habitat will virtually guarantee the presence of doves.

### **Space**

The minimum size of habitat required to support a mourning dove population is not known. However, a mixture of habitat types within a short distance of water and food will increase the number of doves. Doves can fly over a broad spectrum of habitats to satisfy their needs.

### **Reproduction**

Migratory doves begin returning to Kansas in mid- to late February. Most of the birds will have returned by the latter part of March to begin the reproduction process. Males establish territories and begin to look for a mate. The most notable aspect of the breeding season is the cooing call a male dove uses to attract females and warn other males of his territorial claim. Once a mate has been found, cooing and courtship displays stop.

Most nesting begins in April; but in very mild winters,

nesting may begin as early as February. It will continue on a monthly basis until September. Doves will attempt to lay four to six clutches of eggs each year. Thus, mourning doves have the longest breeding season of any North American bird. This long breeding season accounts for the high reproductive potential of these birds. High annual productivity is the key to mourning dove abundance.

In a nation-wide banding study, it was found that of the doves harvested in Kansas about 94 percent were produced in Kansas. This is contrary to popular opinion which holds that many of the doves we shoot are doves moving into and through the state during migration.

Females are programmed to lay two eggs, one a day during each nesting attempt. Mourning dove nests usually consist of sloppily put together twigs and grass sprigs. Occasionally, the birds will use old nests of other birds, porch ledges, wood piles, or the ground for nesting. About half their nests successfully produce young birds.

Both the male and female take active roles in nesting and brood rearing. Once the first egg has been laid, the birds begin incubation. Fourteen days later, the naked and blind chicks hatch. The chicks grow rapidly, and in 12 days they are capable of leaving the nest. For the first few days after hatching, the young are fed "pigeon milk."

Young birds, produced in the early and mid-breeding season, move around with no particular pattern during the summer months, while their parents continue to produce more young doves. Mourning doves are solitary nesters; however, when breeding season ends, the birds become very social and form loose flocks. As the summer season progresses, flock size grows as more and more young birds join the flock. These young birds are usually the first birds to fly south for the winter. Migration typically begins in September, and by the end of the month or early October, most of the birds will have left the state. Some birds remain in Kansas throughout the winter months, and these birds often have missing or shortened toes as a result of frostbite.

Average life-span of the birds in a population is 14 months. By the time the birds return to Kansas, 60 to 80 percent of the population will have died. Thus, mourning doves can be considered an annual crop.

### **Population Management**

Because the mourning dove is a migratory bird, protection and management efforts fall under the jurisdiction of the U.S. Fish and Wildlife Service. Much of the population management for doves centers around hunting. The U.S. Fish and Wildlife Service sets the guidelines for hunting season as well as general laws and regulations based on flyway populations. The KDWP then sets the state's hunting season within these guidelines to provide hunting opportunities for sportsmen while protecting breeding populations.

Even though doves are attracted to agricultural fields,

it is illegal to bait mourning doves or any other migratory bird for hunting. The interpretation of federal laws pertaining to what is legal is subject to change. Any person managing fields for doves would be wise to check with his local conservation officer to determine what practices are acceptable.

You cannot carry grain or any other bait to an area for the purpose of attracting doves to shoot. However, it is legal to grow crops that attract doves and to harvest all, none, or a part of that crop. Doves may be hunted over millet, sunflowers, grain, sorghum, corn, wheat, and other crops that are mowed, disked, or knocked down. You can hunt doves over the crop residues from that field. Any grain or grain residues resulting from normal agricultural practices or wildlife food plots may be hunted over. Simply put, you cannot hunt over grain or crop residues if they were hauled in from another field. You may hunt over areas planted to a winter cover crop as long as the seeding rate does not exceed normal agricultural standards.

Landowners who want to have dove shoots should schedule crop plantings to allow the harvest to conclude before hunting doves in the fall. (see chapter 20, "Dove Food Plots" section). It is more cost-efficient to slightly alter ongoing farming practices to attract doves than it is to intensively manage a small portion of a farm for doves. Landowners should also have a few small feeding fields around hunting areas to serve as refuges for the doves during heavy hunting periods.

Good dove hunting should be available for most of the hunting season if landowners:

- 1) *harvest crops so grain is available one to two weeks before hunting season,*
- 2) *leave sufficient grain in the field to keep the birds around throughout the season, and*
- 3) *limit hunting pressure.*
- 4) *burn wheat stubble prior to season opening.*
- 5) *plant sunflowers in april and keep them weed free.*









## Chapter 31

# Wild Turkey Management

*George Wright*

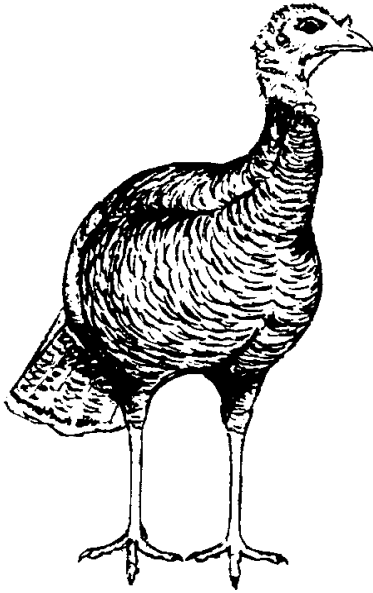

Wild turkeys are the largest, probably the most wary, and one of the most-prized game birds in North America. They are also one of North America's greatest wildlife management success stories. Presettlement turkey populations in this country were estimated to range between 7 and 10 million birds. Within 100 years, the wild turkey became a rare bird throughout much of its range. By 1930, experts estimated there were only 20,000 turkeys left in this country.

Through strict hunting regulations, habitat preservation programs, wild turkey trapping and transfer programs, and proper management techniques, the wild turkey is doing great and can be found in all the lower 48 states. The wild turkey has made a dramatic comeback across Kansas in the recent years. Public interest in this species has soared as wild turkeys are showing up all over the state.

This chapter will provide a better understanding of turkeys and their habitat needs.

## ***What Makes a Wild Turkey a Wild Turkey***

Often called the “king of game birds,” the Eastern wild turkey belongs to a group of ground-nesting, chicken-like birds that include grouse and quail (*Galliformes*). Wild turkeys look similar to their domestic cousins. They are long, lean, and slender and are adapted for walking, running, and flying (they can fly up to 55 mph). Their

domestic counterparts, having been adapted for commercial production, are basically short, heavy, and stocky. Wild turkeys also have buff-colored tips on their tail feathers, whereas domestic turkeys have white-tipped tail feathers like the Mexican wild turkey from which they originated a few hundred years ago. Wild turkeys have larger brains and a more developed endocrine system, which accounts for their adaptability to live and survive in the wild.

Adult males, called gobblers, are about twice as large as hens and generally weigh between 17 and 28 pounds. Adult hens weigh from 8 to 12 pounds. The body feathers of wild turkeys shine with iridescent shades of brown, green, blue, purple, and red in the sunlight. This iridescence is most noticeable in adult gobblers. Other ways to tell the difference between hens and gobblers include the gobbler's red, white, and blue head and neck, a beard, and spurs located on the lower part of the leg. A gobbler's breast feathers are black-tipped, while hens have light-colored tips on their breast feathers. Gobblers also have pronounced wattles (folds of skin below the neck) and caruncles (wartlike growths on the neck). Hens also have wattles and caruncles although they are not as pronounced. A small percentage of hens will also have a beard. Hens have light blue heads and a feathered neck.

## ***Distribution and Range***

Wild turkeys are found throughout North America. Six distinct geographic races or subspecies are recognized—these are based on slight coloration and behavioral differences. The eastern race is the most widely distributed and is found in the eastern United States from Maine to Missouri south to the Gulf of Mexico. Other subspecies of wild turkey are the Florida, Rio Grande, Merriam's, Mexican, and Gould's turkey. Through a trap and transfer program, the KDWP has reestablished a turkey population in all Kansas counties with suitable habitat. Kansas has both Eastern and Rio Grande subspecies of turkey. The Rio Grande is similar in size and general appearance to other species of wild turkey. Coloration of the tips of the tail feathers, which are buff or tan in the Rio Grande's, contrast with the dark brown tips of the Eastern, and the white tips of the Merriam's.

## *Cover, Food, Water, and Space Needs*

### **Cover**

Wild turkey habitat has changed since the arrival of European settlers. The vast tracts of uncut forests present during that era are gone. Despite the extensive forest clearings and the planting of agricultural crops, the wild turkey has flourished because it can adapt to a variety of plant communities. Wild turkeys are forest-dwelling wildlife and require approximately 30 to 50 percent of their range in a mature or nearly mature forested condition containing a variety of tree species, including oaks, hickories, ash, and some pine. However, recent information shows they can survive if only some of the area is forested. Turkeys have done well in Kansas with only piperian strips for woodlands. Bottomland hardwood forests are extremely good turkey habitat because food, water, and cover are close to one another. In addition to the forested areas, turkey habitat should include woodland openings, shrublands, and herbaceous areas.

Turkeys require three types of habitat: winter, summer-fall, and nesting. Turkeys use winter habitat from late fall through early spring. Prime winter habitat should consist of at least some dense woodlands. If neither this forested habitat nor a winter food supply is available, turkeys move into less suitable habitat where they are more susceptible to poachers and predators.

As spring approaches, turkeys move to their nesting and brood-rearing habitats. Nesting habitat is quite varied and should be readily available throughout the state. Turkeys usually nest within a quarter-mile of a permanent water source. Nests are sometimes located at the base of a tree, and the nest is screened or concealed by dense shrubby vegetation ranging from 2 to 4 feet high. Turkey nests are shallow depressions on the ground lined with leaves and grass and may be found at the edge of woods and in pastures, old fields, or other areas having thick vegetation. In southwestern Kansas, a majority of the nests are found in CRP fields.

Shortly after the young turkeys (poults) have hatched, the hen moves the brood to habitat where they can feed on insects. Late summer and early fall habitat often includes open woods, mowed fields, old fields, pastures, and savannahs. These areas provide seeds and green, succulent vegetation, such as clover, and an abundance of insects, which are important to the poults.

Wild turkeys roost in trees at night. Turkey management requires a mature timber that can be used as a roost site. Trees should have horizontal limbs at the 20 to 30 foot level strong enough to support one or more adult turkeys. This timber should also provide an overhead canopy for protection from weather and avian predators.

This information shows that wild turkeys need a diversity of habitats throughout the year. The opportunity

for a higher density turkey population is greater if all the needed habitats are close together.

### **Food and Water**

What do turkeys eat? Turkeys eat almost anything that is not too big to swallow. They are omnivores with a diverse diet. About 90 percent of the turkey's diet is plant matter, and the remaining 10 percent is animal matter. Turkeys are generalists or opportunists, and more than 350 plant species have been identified from turkey crops. Turkey foods fall into five main categories: mast, fruits, seeds, greens, and insects. Acorns and ash are the main foods in the turkey's winter diet. Acorns undoubtedly are the most important winter food source; one study found acorns made up 47 percent of the turkey's winter diet. The birds also eat waste grains, such as corn, soybeans, milo, and other sorghums, if they are available. In agricultural areas, turkeys often depend on waste grain remaining in crop fields for winter food. These foods are very important in agricultural areas with limited forest.

As spring and summer approach, the turkey's diet shifts to green forage close to nesting and brood-rearing habitat. Hens move into open areas where the vegetation green-up occurs earlier than in the forested areas. The variety of green material eaten is amazing and includes grasses, sedges, and a variety of green herbaceous forbs and legumes, especially clover. The hens will eat snails during the egg-laying period to supply calcium.

During the summer and early fall, the turkey's diet shifts again. For the first few weeks after hatching, the poult's diet is dominated by insects. About 75 percent of the young turkey's diet is made up of insects, such as grasshoppers, ground beetles, flies, caterpillars, ants, and crickets. As the poults grow, seeds, fruits, and greens become increasingly important. They eat the seeds of ragweeds, sunflowers, grasses, and numerous other forbs. Favorite turkey fruits include dogwood, wild grape, cherry, sumac, greenbrier, persimmon, and blackberries. To ensure a dependable source of natural foods for turkeys (and future timber), landowners should strive for equal distribution of age and size classes of trees on their lands. This means about one-third of the timber would be in small trees, one-third in pole-sized trees, and one-third in mature trees. Turkeys benefit when openings are created by harvesting some timber. Such clearings enhance shrubs and vines and allow a lush growth of grasses and weeds.

A permanent water source is a necessity for wild turkeys. Turkeys may get some of their water needs from dew on plants or in the green, leafy vegetation they eat. However, a year-round source of water (streams, rivers, lakes, or wetlands) is necessary. In areas where creeks dry up during the summer, ponds or lakes will be essential if turkeys are to stay in that area. As mentioned earlier,

turkeys usually nest within a quarter-mile of water, and roosts are often located next to a permanent water source. If permanent water is not available, ponds can be constructed in strategic positions. One pond per 160 acres would be ideal. Turkey watering ponds located in the woods do not have to be very big. Ponds 30 to 40 feet across and gently sloping to 7 or 8 feet deep will undoubtedly supply a dependable source of water all year.

### Space

Turkeys are active only during daylight hours. During the night they roost in trees. Turkeys require substantial space to meet their needs over the course of a year in search of food and cover. The annual home range for turkeys may be several square miles. The size of their winter range depends on the availability of food. The scarcer the food supply, the larger their range will be (increasing their chances for predation, poaching, or mixing with domestic turkeys). The average winter home range will be about one square mile. Summer range is generally a little smaller than winter range. Flocks often move several miles between summer and winter ranges.

### Reproduction

Wild turkeys like company. When turkeys become lost or separated from one another, they communicate with a variety of calls. This social trait has survival advantages, for in numbers there is strength. During the winter, turkeys normally separate themselves into three distinct groups: adult gobblers, young gobblers, and hens of all ages. As spring approaches, these flocks begin to break up, and the birds start their courtship and mating rituals. By mid- to late March, male turkeys (toms) set up territories and begin gobbling and strutting in hopes of attracting a "harem" of hens. Gobbling begins each morning on the roost and continues through daybreak.

Adult gobblers do most of the breeding and will try to attract as many hens as they can. Juvenile gobblers, those nearing 1 year old, usually do not partake in mating although some of them may be sexually mature. Once a female has been attracted, the tom stops gobbling and begins strutting and displaying in hopes of enticing her to mate with him. Most hens, regardless of age, will breed each year.

Once mating has been completed, the hen begins searching for a suitable nesting location. Hens often continue mating while laying eggs. Most hens begin laying activities by mid-April. The hens lay a clutch of 11 to 12 eggs in about 14 days because they skip a day or two early in laying. Once the clutch is complete, the hen will incubate the eggs for 28 days. Peak hatch occurs in late May and early June. Hens that are unsuccessful in their first nesting attempt will often reneat. After hatching, the hen takes her brood out immediately to feed on insects.

The young poults grow rapidly and live on the ground for about two weeks. By this time, they can fly and roost on

lower branches of trees. As summer passes, family groups and brood flocks band together in larger groups. When winter approaches, the young gobblers break away and form their own distinct flocks. A few young gobblers will occasionally remain with the hens until spring breakup.

### Population Dynamics

Numerous factors affect the ups and downs of turkey populations. The importance of any one factor in a given year varies. Weather conditions, during or shortly after hatching, are the most important natural factor (other than a lack of habitat) affecting reproduction. Turkey poults, much like quail and grouse chicks, are very vulnerable to cold, rainy weather for the first few weeks of life. If conditions are warm and dry during early brooding, poult survival will be good.

Only about half of all hens will be successful in raising a brood due to a variety of factors, including nest predation, predation on nesting hens, and disturbance factors such as mowing. Most poult mortality occurs during the first four weeks after hatching. A variety of predators will eat eggs, poults, and nesting hens. Coyotes and raccoons are the main predators of turkey nests and poults. Skunks, foxes, bobcats, and owls are also known to take young turkeys. Most gobblers are lost to hunting, whereas predation on nesting and brooding hens accounts for most female losses. Illegal hunting also has a serious impact on turkey populations.

Research is currently underway in extreme southwest Kansas to better understand the declining turkey population in that region of the state.

While disease is not normally a problem for wild turkeys, any contact between domestic poultry and wild birds can be disastrous because wild turkeys are susceptible to the same diseases as their domestic cousins and other poultry. Blackhead, a protozoan infection carried by the cecal worm in chickens and pheasants, is the most dreaded of turkey diseases. Infection of local populations may come from the release of pen-reared birds, from free-ranging poultry, or from lands where infected poultry manure fertilizer has been used.

Do not artificially feed wild turkeys. The concentration of turkeys in a small area is an open invitation to the spread of disease and poaching problems should unscrupulous folks find the feeding site.

Do not release any kind of pen-reared turkeys into the wild. The possibilities of genetic pollution or disease introduction are very real threats to wild populations. Because of all the negative aspects of pen-reared turkeys, possessing live wild turkeys is illegal in Kansas and most other states. A game breeder's permit is required for those engaged in the business of raising and selling wild birds, game birds, and other wildlife, including wild turkeys. The

KDWP has spent thousands of dollars restoring this magnificent bird across the state, and the presence of pen-reared turkeys could jeopardize much of the restoration progress made during the past decade.

It would also be wise to prevent any contact between wild turkeys and domestic poultry, especially turkeys and chickens. The best solution would be to keep domestic poultry in a pen where they would be better protected and could not mix with wild turkeys. The old adage that “the best management for wild turkeys is a locked gate” still holds true today. Turkeys tolerate normal farming activities; however, constant harassment may cause turkeys to leave an area.

### *Where We Are Today*

The wild turkey has influenced our lives in several different ways. Its influence began with the Pilgrims when Thanksgiving came to symbolize the abundant riches of a new land. Benjamin Franklin was so impressed with the wild turkey that he wanted it to be our national symbol instead of the bald eagle because it is such a stately and intelligent bird. When this country was settled, it provided a plentiful source of food and income (at times turkeys sold for 6 to 25 cents) for the pioneers.

Things began looking up for the wild turkey during the 1930s. Research studies were initiated, funded with Pittman-Robertson monies, to explore the life history of turkeys. Results from these studies help set guidelines for re-establishing wild turkey populations into suitable habitat.

As woodlands began to reappear in the landscape, suitable turkey habitat was created. One of the biggest problems facing wildlife managers was how to restock turkeys into suitable habitat. Initial attempts to stock pen-reared birds was greeted with failure. This practice continued until research studies demonstrated the differences in wildness and survivability of wild turkeys

over their domestic counterparts. Thus, the new strategy was to capture live wild turkeys and transport them into new habitat. This idea worked well in western states but met with initial failure in the east until an efficient, cost-effective method of capturing turkeys was developed.

In the 1950s, the cannon-net was developed, and wild turkey trap and transfer programs took off in the eastern United States. Today, the wild turkey has been reestablished throughout this country, and populations continue to grow.

Some historical records state that turkeys were once abundant in Kansas. By the early 1900s, their gobble was a thing of the past. By the 1950s, some Rio Grande turkeys from Oklahoma had crossed into Kansas and established themselves along the border. The first trap and transplant of wild turkeys occurred in 1959 when 26 birds were obtained from Oklahoma and Texas. In the winter of 1966, the Kansas Fish and Game Commission received 125 wild trapped Rio Grande turkeys from the King Ranch in Texas. These turkeys were obtained by trading 250 Lesser Prairie Chickens for these birds. This was the first major stocking effort to bring back this species. Some counties where releases were made include, Barber, Clark, Reno, Ellis, Morton, Graham, Norton, and Cheyenne. The following year 85 birds were received from Oklahoma in trade for walleye fry. These birds were released in the southwest and mid-part of the state. After watching and learning from failures of other states to establish turkey flocks using pen-reared birds, a decision was made to trap and relocate birds within the state. In 1968, in-state trap and transplant operations were begun, and no further out-of-state Rio Grande trades were made.

Information showed that the Rio Grande turkeys were not doing well in areas of the state with more than 30 inches of rain. Eastern turkeys were received from Missouri during the mid 1970s in trades for native forb seed. These Eastern turkeys were released in those two tiers of counties immediately bordering Missouri.

## Questions for Chapter 31

1. What types of cover do wild turkeys require?
2. Is a permanent source of water important for wild turkeys? Why?
3. What types of foods do wild turkeys eat in Kansas?
4. What are the wild turkey's space requirements?
5. Why shouldn't domestic and wild turkeys mix?

Name \_\_\_\_\_





## Chapter 32

# Attracting Song Birds to Your Yard

Georgia Bryan and James Pease

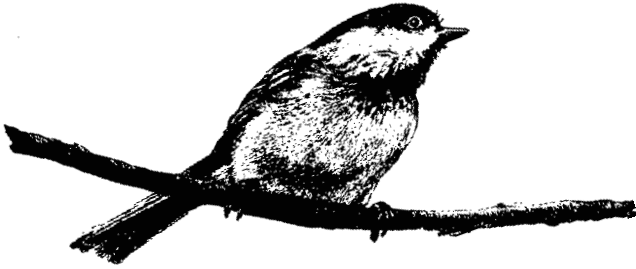

A recent government survey found that bird watching is second only to gardening as the most popular leisure-time activity in the United States. Attracting birds to the backyard is easy by providing what the birds need.

Although the birds derive the primary benefit from efforts to attract them, bird watchers receive a number of benefits as well:

- A yard landscaped to attract birds can increase the value of the property.
- Landscape plantings can be chosen for their attractiveness to people, as well as to the birds.
- Plantings can help conserve energy. For example, conifers around a home reduce heating costs in the winter, and shade trees reduce cooling costs in the summer.
- Birds feed on damaging and nuisance insects.
- Birds provide a source of entertainment.

The only drawback to attracting birds is that unwanted wildlife may also be attracted. While it is possible to deter some of them, unwanted species often must be tolerated.

Anyone setting out to lure the birds to the yard becomes, in essence, a wildlife manager. The same basic principles of wildlife management can provide a background for understanding how to attract them most effectively. To survive, all wild animals need *habitat*, which is comprised of four essential factors: (1) space, (2) food, (3) shelter, and (4) water.

## Space

Space is the area needed by a wild animal. Just as some people are happy in a city apartment and others need a ranch with no neighbors nearby, some bird species need more space than others. Some birds may need more space than a yard provides, and thus can never be attracted. Some may be attracted with as little space as an apartment balcony.

Two kinds of space used by wild animals are:

- *home range*—the entire area that an animal uses to eat, sleep, and go about its daily activities;
- *territory*—a portion of the home range an animal defends against intruders; it is usually where the animal raises young.

Usually, the male bird establishes and defends the territory. In the spring, the brightly colored male sings to attract a mate and to announce to other male birds of the same species the location of his territorial space. After the pair builds a nest, the male continues to defend the territory while the female hatches eggs. Male birds can be extremely aggressive and will attack anything that seems to be a threat. In his zeal to defend his territory, the male may attack his own reflection in a window or in the side mirrors and shiny hubcaps of a car. This behavior is most often seen in robins and cardinals. It can be stopped by temporarily covering the outside of the window with a towel or a piece of cardboard to eliminate the reflection.

Space is limited by the area of a yard or farmstead, so this factor cannot be controlled. But food, water, and shelter are elements of habitat that can be manipulated to manage birds in yards. Provide these elements to attract birds; remove them to keep the birds away. All are essential needs and must be provided to get the greatest number and diversity of birds.

Variety is an important part of backyard wildlife management. To ensure the greatest variety of bird species, furnish the greatest variety of food, shelter, and cover by providing various types of feeders, houses, and plantings.

To attain the goal of attracting birds, consider each of the following three elements of habitat: food, shelter, and water.

## Food

Food sources for birds include seeds, fruits, berries, and insects. To the birds, there are two main kinds of food:

- *preferred foods*—those the birds like the best. They eat such foods first and very quickly—whether provided by people or by nature.

- *persistent foods*—the bird version of liver and spinach. Most birds do not like persistent foods as much as the preferred. Persistent foods are those berries, fruits, and nuts that are not eaten right away. Later in the winter they provide an important source of food when all preferred foods are gone.

Attract birds using plantings and feeders. It is best to use a combination of the two. Start with feeders until plantings are mature. After plantings are producing food, continue with the feeders so as to lure birds to a spot where they can be seen and enjoyed. Variety is the key. Provide a variety of food; plant as many species of plants as possible.

## Feeders

Use an assortment of feeder types mounted at several different levels, and provide a miscellany of food types. The nutritional needs of birds varies somewhat with the season, so offered food should change with time of year.

The kind of bird attracted will also vary—some are residents year-round; other birds are migrants passing through, moving from their summer to their winter range and back again. An example of a resident bird is the black-capped chickadee. A common migrant species is the American robin.

Feeders should be placed in the open so cats and other predators cannot sneak up on the birds. At the same time, the feeders should be near some cover so the birds don't waste their energy flying back and forth from the feeder to the bushes. Try to have some cover about 6 feet away. Although feeders should be provided at several heights, they never should be less than 5 feet off the ground. Locate feeders where they will be as sheltered from prevailing winds as much as possible.

Ideally, feeders should be located where they easily can be seen from a window so that the birds can be enjoyed. However, recent research has shown that bird/window collisions cause many deaths of birds each year. Even birds that just look stunned and are able to fly away after a collision, often die from blood clots and other brain damage. The problem is that birds do not recognize glass as a barrier. They often can see trees and sky reflected in a window, or they can see through sets of windows to trees beyond and think they can fly to this "habitat." The use of hawk silhouettes and other scare devices does not significantly reduce bird/window collisions.

But several things **can** be done:

- place feeders far away from windows in the back of the yard where they can still be seen, especially with binoculars;
- place feeders very close to the window, no more than 1 foot away—or use specially designed window and ledge feeders—to keep the birds close-up, helping keep collisions with the window at low-speed;

- put plastic or nylon netting over the window, using a small enough mesh (between ½ and 1 inch) so that birds cannot slip through the net. Coverings must be on the outside of the glass to rid the window of reflections. Clean up feeders regularly, especially platform feeders which quickly become contaminated by droppings. Store seed in a clean, dry place. Although recent research has shown that feeders are not major sources of disease, **clean feeders and clean, non-moldy seed are important factors in reducing outbreaks of disease.**

## Fall and Winter

Start fall and winter bird feeding no later than October. Birds quickly establish "routes" of feeders that they visit during the day. If feeding is started too late, not as many birds will be attracted. Continue feeding until April or May—until more natural food sources are available.

Many people worry about discontinuing feeding while they are on vacation, but this is rarely a problem.

For the insect-eating birds, like nuthatches and woodpeckers, provide a treat by putting suet out. Prepared suet treats can be purchased at supermarkets or bird seed stores; but the birds like plain beef fat from the meat counter just as well. The suet can be put in any type of container that has holes for the birds to peck through—a nylon mesh onion or fruit bag, a plastic berry basket nailed to a board, or a commercially available suet feeder. To make a wire suet feeder, be sure to coat the wire with a rubberized coating that comes in a can from the hardware store. Anything moist can freeze to bare metal, including birds' eyes or tongues. Do not provide suet in warm weather, because it quickly becomes rancid.

The majority of birds during fall and winter will be attracted to seeds. Purchase bird seed carefully. Many pre-mixed bird seeds contain wheat and primarily fillers. Birds will throw these from the feeder looking for food that they prefer—like sunflower seeds. Find a store that sells seed separately by the pound and buy the types and quantity of seed wanted. Otherwise, buy the seed mix with the highest proportion of black (oil-type) sunflower.

One of the best mixes for attracting a variety of birds is 50 percent black (oil-type) sunflower, 35 percent white proso millet, and 15 percent cracked corn. The oil-type sunflower is all black and is preferred over the black-striped sunflower because it attracts a wide variety of birds. The white proso millet is a favorite of mourning doves, dark-eyed juncos, and most of the sparrows. The cracked corn is essentially a filler, but it is more preferred than something like wheat. This mix is best provided in a house or platform feeder.

Another seed that is a favorite of several species of birds is peanut kernels (not hearts). Provide these separately in a small tubular or globe feeder.

The American goldfinch is a year-round resident. Males lose their bright yellow breeding plumage in the winter and become a duller olive color like the females. Goldfinches, house finches, purple finches, and pine siskins can be attracted to feeding stations by providing niger thistle seed in tubular thistle feeders. There is no need to worry about having a weed problem with niger thistle. This type of thistle cannot survive the winter in the Midwest.

Sometimes aggressive birds like house sparrows and blue jays cause problems at the feeder because they drive the other birds away. One way of reducing the problem is to provide a mixture of cracked corn and white proso millet on a platform feeder in the back of the yard away from the feeding station. This will lure some problem birds away. Where house sparrows are a nuisance, try feeding straight black (oil-type) sunflower seed. The millet in seed mixes is attractive to native sparrows, but also to house sparrows. Make it slightly more difficult for house sparrows and any larger birds to feed by using tubular feeders without perches. These feeders are still easily accessible to the clinging birds like nuthatches, chickadees, and titmice.

Squirrels are often troublesome because they eat large quantities of seed and may destroy the feeders. Try providing ears of corn at another location to lure squirrels away from a feeding station. Other methods of excluding them from feeders include placing metal cones on the pole below the feeder or on the chain above the feeder. Squirrels will have trouble climbing over these.

Additionally, several “squirrel-proof” feeders are on the market. One has a built-in counter-balance that lets birds land on the perch and feed; when the heavier squirrel sits on the perch, it tilts—causing a door to close over the seed. Some manufacturers guarantee their feeders and will replace anything damaged by squirrels at no cost. Many bird watchers enjoy the challenge of trying to outwit squirrels at their feeders.

### *Spring and Summer*

Although many people feed birds only in the winter, some continue to enjoy this hobby through spring and summer. At these times most birds are eating fruits and insects. If house sparrows are a problem, discontinue feeding seed. However, American goldfinches will still be attracted with a thistle feeder. By watching closely, bird watchers can see the males turn from drab olive green to their striking black and yellow breeding plumage.

Some people provide insects for the birds during the summer. These insects not only supplement the birds’ diet, but are also used by the adults for feeding young. One way of providing insects is to raise them. The yellow mealworm and the dark mealworm are inexpensive and fairly easy to raise. The mealworm is the larvae of the darkling beetle. They do not carry human diseases but can be pests around

stored grains. Purchase mealworms at a pet store or a bait shop during the fishing season. Place no more than 250 worms in a 5-gallon plastic bucket with a loose-fitting lid and 3 inches of wheat bran in the bottom. Add a slice of potato ( $\frac{1}{4}$ -inch thick) once a week for moisture. Provide a place for adults to lay their eggs by laying a piece of cloth or paper towel on the wheat bran. Enhance egg-laying by sprinkling the cloth with water every two to three weeks. When the wheat bran is depleted and there is a build-up of insect droppings, start the process over. Use a strainer to sift out adults and larvae and place them in a new container. It could be a while before the adults are capable of reproducing, depending on their size when purchased. Newly hatched mealworms require six months in warm temperatures to grow to full larval size—about an inch long. The full-grown larvae then turns into a pupa and takes another nine to 20 days to emerge as adults.

To feed the meal worms to the birds, use forceps to pick some out or use a kitchen strainer. Use the mealworm larvae that have just molted. They are white in color instead of the normal yellow or the white pupae. These mealworms are easier for young birds to digest. Place the mealworms in a tray with the sides in the shade so they will not spoil quickly. Enclose the tray with chicken wire to keep out larger birds and squirrels. There is some concern over feeding live mealworms to nestling birds; however, dead larvae may not be as attractive to the birds. Try providing them both ways and see which the birds prefer.

Another way to acquire insects for the birds is by using a bug “zapper.” Hang a bag underneath the bug zapper to catch the dead insects and place these in a tray for the birds. Or suspend a plastic tray underneath the zapper with a few tiny holes in the bottom to allow it to drain. This tray will catch dead insects as they fall from the bug zapper at night and will be a feeder for the birds during the day when the bug zapper is turned off. Another method is to catch some insects with a plastic bag underneath a plain fluorescent bulb, or a black light with a sheet draped over it placed outside at night.

Because insects are an essential food source, especially to young and growing birds, it becomes especially important to be responsible about the use of house and garden insecticides around the yard. Some common household and garden insecticides are harmful to birds. If the number of insects in the yard is drastically reduced by spraying, birds will be forced to go elsewhere to look for food. Rather than using insecticides as a “preventative” measure, make sure there is an insect problem first. **Caution: If insecticides must be used, follow label directions exactly. Dosages higher than recommended could kill nontarget wildlife.** If use of an insecticide is essential, look for one containing pyrethrins or pyrethroids, which are less harmful to birds and mammals than others. Be careful not to spray it around or let it run off into adjacent water, because it is highly toxic to fish.

Fruit also may be used to attract birds in the spring and summer. To attract northern orioles, put out slices of orange; or use one of the commercial oriole feeders in the early spring during oriole migration. The northern oriole spends its winters in areas where citrus fruits are an abundant food source, so it becomes accustomed to eating fruit during the winter. But when it comes to our area for the summer, citrus fruits are not available, so it feeds instead on insects. The trick to attracting orioles is to provide the fruit during their migration while their diet is still in transition before they've changed to insects.

Apples, oranges, and raisins throughout the spring and summer also will attract birds like bluebirds, mockingbirds, woodpeckers, jays, grosbeaks, and waxwings. To provide oranges and apples, impale a half fruit on a long, headless nail driven into a tree or board. Apples also can be diced and placed out on a tray.

Hummingbird feeders can be used to attract these tiny birds. Use one part sugar to four parts water or commercially prepared hummingbird foods. Replace with a fresh mixture every three to four days. It is not necessary to use red food coloring because the feeders generally have red plastic on them to attract the birds. **Do not use honey water.** The honey rapidly cultures a mold that can kill the hummingbirds.

### *Plantings as Food Sources*

When selecting vegetation to attract birds, plant a variety of plant species. Try to choose plants that are native in the area. They will not only grow better than nonnatives, but the birds will recognize them readily as a source of food. Pick a combination of preferred and persistent food sources so that food will be available longer. Plan the landscape plantings on paper first. Start with a yard map drawn to scale. Mark all existing plants, buildings, fences, and other structures currently in the yard. Then draw in the wildlife plantings, gardens, and the water sources. Draw all plants at their maximum size so the plantings won't be crowded. Plan the plants so that they vary in height in a "stair-step" pattern—large trees on the perimeter, smaller trees and tall bushes toward the center, then lower-lying bushes and flowers, and finally, grasses and other ground covers. In choosing plant locations, be sure to consider available light, water, soil type, soil pH, and other site requirements. Consult with nursery or garden center personnel, gardening books, or a local Master Gardener.

Some examples of preferred food source plants are the common elderberry and common chokecherry—all of which produce fruit in the summer—and the American plum and American mountain-ash which produce in the fall. Although tartarian honeysuckle bushes are preferred by birds, they are not recommended because of their invasive habit—a tendency to escape into forests, parks, and other natural

areas. Some examples of persistent food source plants are common hackberry, red cedar, and gray dogwood. Many people plant flower gardens and other plants specifically to attract hummingbirds.

Many of the plantings that attract hummingbirds attract butterflies as well. Hummingbirds are attracted to plants that have tubular flowers and/or are red in color.

Some examples of hummingbird plants are: scarlet trumpet vine, scarlet trumpet honey-suckle, daylily, and blazing stars.

Recently, ornamental grasses have been used in plantings instead of flowers. These grasses can be placed among other plants or planted in patches alone. These "grass gardens" can be very attractive to wildlife if native prairie grasses are selected with some prairie flowers and other forms mixed in. Wildlife and butterflies will be attracted to small patches; however, the bigger they are, the better.

### *Shelter*

All birds need shelter for cover, roosting, and nesting. The kind of shelter a bird will use can vary with the reason the bird is looking for shelter, the species of bird, and the season. For attracting nesting birds, provide bird houses, shelves, trees, and bushes. For protection against winter storms and winds, add evergreen trees and shrubs.

### *Spring and Summer*

To attract birds to the backyard in the summer, provide both natural and artificial places for the birds to nest. When landscaping to provide cover, chose a variety of plant species which attain differing mature levels; some birds prefer to nest high in treetops, while other birds prefer to nest in low-lying bushes or on the ground. Choose native plants when possible. Some plants that provide good sources of cover are raspberry, crab apple, elderberry, nannyberry, wild plum, and red cedar. For more information on these plants, see the references listed for landscape plantings under "Food." These plantings may take some time to mature, so provide some cover and nesting areas quickly by putting brush piles in the yard.

Putting up bird houses is another way to provide shelter before the plantings are mature; later, these bird houses supplement the shelter offered by the plantings. Many types of bird houses, shelves, and boxes can be made or purchased that will enhance the backyard for the birds. Nest boxes can provide homes for birds that nest in holes in trees—from woodpeckers to wood ducks. Make nest boxes for birds as large as owls and as small as chickadees and wrens. Nest shelves are for birds that nest relatively out in the open needing only a small amount of shelter—like robins, phoebes, and mourning doves. Purchase houses or make them out of wood, plastic buckets, or gourds.

Purple martin houses are a little different. They have numerous “apartments” under one roof, because martins like to nest in colonies. Purple martins eat a large number of nuisance insects—like mosquitoes—so they are a beneficial species in backyards. Purple martin houses need not be expensive. Some people have had great success attracting purple martins to several gourd houses hung together on the same pole.

For more information on bird houses, shelves, and boxes see appendix A. For more detailed information obtain: *Shelves, Houses and Feeders for Birds and Squirrels*, G209 1, and *Woodworking for Wildlife*, Minnesota Department of Natural Resources, 500 Lafayette Rd., Box 7, St. Paul, MN 55155-4007.

### ***Fall and Winter***

To attract birds to the yard in winter, provide them with cover. Some of the best winter cover is found in evergreen trees and shrubs. These plants also provide food and summer nesting sites. Some good evergreens for wildlife include red and white cedar, boxwood, white pine, scotch pine, and any of the spruces. For more information on winter cover plants see the landscaping publications listed previously.

Before plantings mature, temporary shelter will begin attracting birds. This temporary shelter can be in the form of brush piles or even a discarded Christmas tree propped up near the feeding station.

### ***Water***

A source of water is essential for birds year-round. Even if a stream is near, more birds can be attracted if water is provided.

### ***Spring and Summer***

Providing a water source will attract a greater number and diversity of birds. Water can be provided in a number of ways: a garbage can lid, a clay pot saucer, a half of a wooden barrel, a commercially available birdbath, or an inground, backyard pond. Backyard ponds can be constructed by lining the ground with heavy plastic or by setting a child’s wading pool into the ground. For instructions on creating a backyard pond see: *A Simple Backyard Pond*, by Louise Dove, The National Institute for Urban Wildlife, 10921 Trotting Ridge Way, Columbia, MD 21044.

Birds are attracted to water movement. Hang a bucket full of water with a small hole in the bottom over the bird bath. The slow dripping into the birdbath makes it more attractive to the birds. Do the same thing with a hose or a commercially available mister or dripper designed for this purpose. With backyard ponds, a waterfall can be created with rocks and a large aquarium pump to circulate the water from the pond over the rocks.

### ***Fall and Winter***

Water also is important to the birds in winter. A bird bath with a heater to keep the water from freezing will attract more birds to the yard. Commercial heaters are available at many garden stores, farms stores, and other stores that sell bird feeding supplies.

### ***Other References***

*Gardening With Wildlife Kit*, National Wildlife Federation, 1412 16th St. N. W., Washington, D.C. 20036; *The Audubon Society Guide to Attracting Birds*, by Stephen Kress, Charles Scribner and Sons, New York, NY; *Wildlife Management on Your Land*, by Charles Cadieux, Stackpole Books, Harrisburg, PA.



## Questions for Chapter 32

1. List five benefits to attracting birds to your yard. Are there any drawbacks?
2. How can you reduce bird/window collisions?
3. What is a good treat for insect-eating birds like nuthatches and woodpeckers?
4. How do you avoid unwanted problems with house sparrows or squirrels?
5. Should you feed birds year-round?
6. Why does honey water sometimes kill hummingbirds?
7. How do you use plantings as food sources?

Name \_\_\_\_\_





## Appendix A. Artificial Nesting Structures

Artificial nest boxes are a useful wildlife management technique to enhance the nesting habitat for wildlife that require large, hollow trees. They are used by a variety of bird, mammal, reptile, and amphibian species. Building and placing these nest boxes is a popular pastime and hobby for many Kansans interested in wildlife.

There are designs for 10 different nesting boxes in this appendix. It is important that nest boxes be built according to exacting specifications and be placed in the appropriate habitat. If not, they can quickly become house sparrow “slums.”

### *General Instructions for Building Nest Boxes*

1. Make the boxes specific for each species of wildlife you are trying to attract. This is important because various wildlife require different size boxes and entrance holes. Be sure to place the box at the correct height and in the appropriate habitat for each species of wildlife you are trying to attract.

2. Most boxes will need to be checked and cleaned at least once a year. To make this servicing job easier, be sure that one side of the box is hinged. This can be accomplished by attaching rust-proof hinges or placing a nail in the same location on each side of the door at the bottom and no nail at the top. At the end of the nesting season leave the door to the nest box open during the winter. This will discourage mice from using the box. Mice can become a problem the next spring by defending the box against the returning songbirds. They can even kill and eat the returning birds.

3. Be sure to provide drain holes in the bottom of every house. Provide adequate ventilation in the house by drilling several holes near the top of the house or leaving a tiny space between the roof and sides of the house. **Do not place a perch** on any box because **ONLY HOUSE SPARROWS AND STARLINGS USE A PERCH.**

4. Use well-seasoned hardwood lumber and galvanized nails if possible. Woods that are particularly good include cypress, redwood, western cedar, and eastern hemlock. Other species such as pine or fir will work but will deteriorate faster. **Do not paint or treat boxes with a wood preservative.** They will weather naturally. While painted or treated boxes may last longer, these materials may make the box too warm, or they may give off toxic vapors. If you use hardwood lumber, be sure to drill pilot holes for the nails so the wood will not split.

5. All nest boxes (except wren houses) should be firmly attached to a post, tree, or building depending on the species. The best place for many boxes is on a post. All nest boxes should be protected by a predator guard. Do not nail a nest box to a living tree. Either wire the box so it is firmly

attached, or use a lag screw and washer so the screw can be loosened as the tree ages.

6. With the exception of purple martin and wood duck boxes, houses should be spaced according to the territorial needs of each species. For example, bluebird houses should be placed about 75 to 100 yards apart. Wood duck boxes should be clustered, while martins require an “apartment house” style nest box.

7. If house sparrows or European starlings begin nesting in the box, remove their nest and eggs. These species are not protected by state or federal law. You may have to remove nests and eggs six or seven times before the birds abandon the site. You can minimize sparrow use by trapping them with an elevator-type sparrow trap. (This trap is available from several commercial vendors. Contact the Extension Wildlife Specialist at Kansas State University for information on sparrow traps.)

**Table 1. Kansas wildlife species known to use nest boxes designed for cavity-nesting birds**

<b>BIRDS</b>	<b>MAMMALS</b>
American Robin	Big Brown Bats
Eastern Bluebird	Little Brown Bats
Carolina Chickadee	Deer Mouse
Tufted Titmouse	White-footed Mouse
European Starling	Eastern Woodrat
Eastern Phoebe	Golden Mouse
Great Crested Flycatcher	Eastern Gray Squirrel
House Finch	Fox Squirrel
House Sparrow	Southern Flying Squirrel
White-breasted Nuthatch	Virginia Opossum
Barn Swallow	
Purple Martin	<b>AMPHIBIANS &amp; REPTILES</b>
Tree Swallow	Gray Tree Frog
Downy Woodpecker	Green Tree Frog
Northern Flicker	Broadheaded Skink
Pileated Woodpecker	Five-lined Skink
Red-headed Woodpecker	Rat Snake
Red-bellied Woodpecker	
Carolina Wren	
House Wren	
American Kestrel	
Barred Owl	
Common Barn Owl	
Eastern Screech Owl	
Wood Duck	

### Tree Squirrel

1. Construct the box following the plans outlined in Figure 1. Use rough-sawed 1-inch cypress, redwood, western cedar, or hemlock lumber.

2. Place the completed box in older oak or hickory trees that are at least 10 inches or more in diameter and at least 20 feet tall (taller trees are preferred).

3. Place the boxes in woodlands where there is abundant food and natural den trees average no more than one per acre.

4. Place the boxes 20 to 30 feet up in the tree no later than December 1.

5. Distribute the boxes in woodlands at a rate of 1 to 4 per acre depending on the number of natural cavities present.

6. Attach the den box on the tree with #9 wire or nails so the opening is away from the prevailing winds and adjacent to the tree.

7. Place 2 to 3 inches of wood chips, shavings, or tree leaves in the bottom for nesting material.

8. Clean the box every two years.

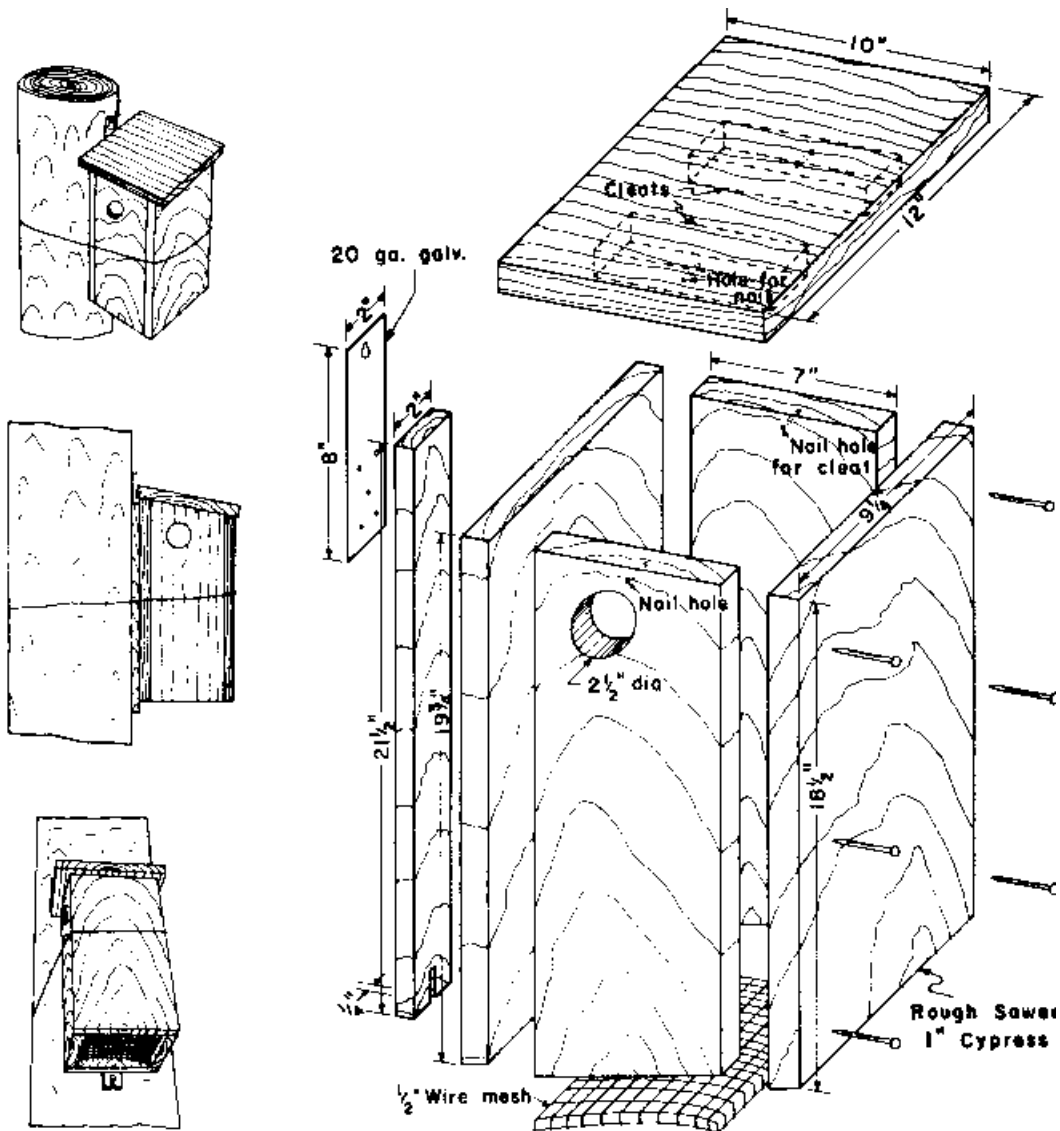

Figure 1

### American Kestrel, Eastern Screech Owl, Flying Squirrel

1. Construct the box following the plans outlined in Figure 2. The best wood to use is western cedar, cypress, redwood, or hemlock. You can also use any commercial lumber or plywood if these woods are not available. Do not use any wood preservatives or paint on the inside surfaces. If you use a less expensive wood, paint or wood preservatives on the exterior surfaces may extend the life of the box.

2a. Place the completed box 10 to 15 feet above ground in relatively open country for kestrels. Several ideal locations include in an orchard or on an interstate or parkway road sign. The grassed median of a four-lane highway provides ideal habitat for kestrels. These boxes are also predator-proof because raccoons, cats, or snakes cannot climb the steel posts that support the sign. If you plan on placing a nest box on public rights of way, get permission from the Kansas Department of Transportation or other

highway management agency. The entrance hole should be placed to the south or west.

2b. Boxes used for screech owls should be placed in open woodland terrain (the preferred location is on the edge of a woods next to a field or wetland). Flying squirrel nest boxes should be placed at least 10 feet high in trees located in hardwood forests. Attach a predator guard, a sheet of tin or aluminum wrapped around the tree, several feet below the nest box (Figure 3).

3. Install new boxes about half a mile from each other. Clean old boxes (install new boxes) in January and February before kestrels, screech owls, or flying squirrels begin nesting.

4. Place 1 to 2 inches of wood chips or shavings in the bottom of the box.

5. Check the boxes every 1 to 2 weeks to remove house sparrow or European starling nests and eggs. These species are not protected by law and can easily take over a nest box.

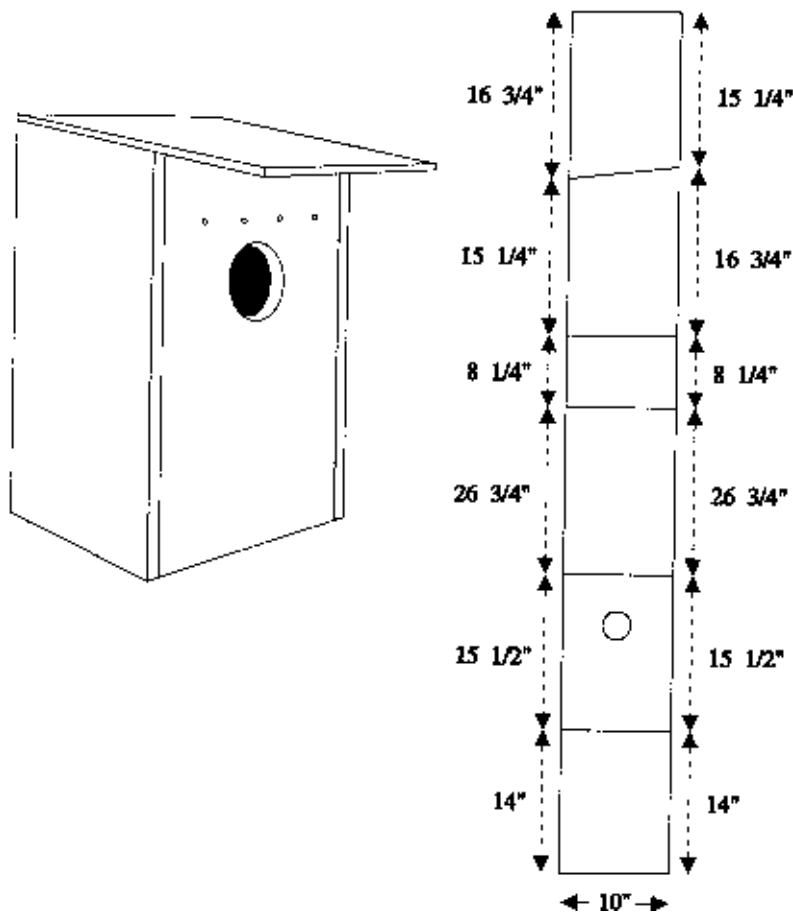

Figure 2

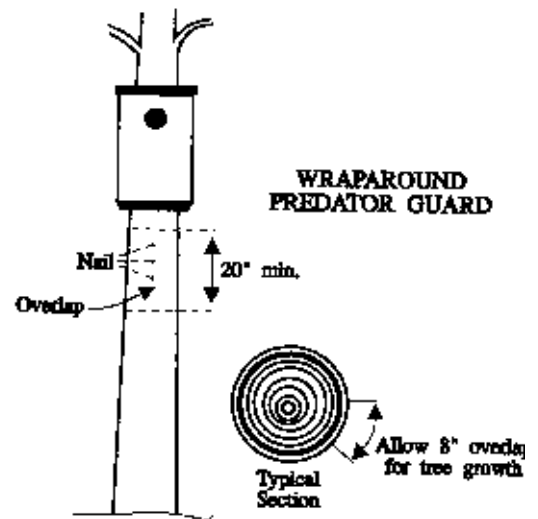

Figure 3

Since the entrance hole diameter is about 3 inches, persistent starling and house sparrow control is necessary.

### ***Wood Duck, Raccoon, and Tree Squirrel***

1. There are numerous designs for this type of nesting box including a top cleat (sliding), top hinge, side pivot, and side hinge design (Figure 4).

2. Use the template in Figure 5 as a guide (trace it onto the wood using carbon paper) to cut the necessary size entrance hole for either wood ducks or raccoons. Cut the hole in the front piece so that the center of the hole is 5 inches from the top of the board. If you are making a nesting box for squirrels, cut the hole on a side panel rather than the front panel.

3. Construct the nest box following the plans outlined in Figure 6. Use seasoned redwood, cypress, or western cedar lumber. Do not paint or treat the boxes with a wood preservative because some colors may repel the ducks and dark colors may make the box too hot. The boxes will weather naturally. Use hot-dipped or ringed galvanized 8-penny or 10-penny nails. To avoid splitting the wood, drill pilot holes before nailing together. Remember to drill four drain holes in the floor. Place a 3 to 4-inch strip of  $\frac{1}{4}$ -inch hardware cloth inside the box under the entrance hole to act as a ladder when the young ducklings leave the box.

4. Add three to four inches of wood chips or shavings to the bottom of the box. This is important because female wood ducks do not bring nesting material to the cavity.

5a. Place the completed boxes in small groups of 2 to 4 per acre **OVER WATER**. Attach the boxes to posts or dead standing timber about 6 to 8 feet above the water's surface. Because wood ducks are not strongly territorial, several boxes can be placed close to one another. Often, wood duck boxes have been widely scattered throughout woodland areas close to water. It is difficult and inefficient to maintain and service these boxes. **IT IS MUCH MORE EFFECTIVE TO CLUSTER YOUR NEST BOXES IN A SMALL AREA.**

5b. If a wood duck nest box must be placed in a tree close to water, attach it more than 20 feet high in the tree with the entrance hole facing the water. Boxes should be placed in trees 10 to 30 yards from the water's edge. Remove any overhanging tree limbs close to the box to make the entrance more visible to wood ducks while preventing easy access for predators.

5c. For raccoons and squirrels, place the completed box in a live or dead tree that measures at least 12 inches in diameter. The boxes should be placed at least 10 to 20 feet high with the entrance hole facing to the south or east. Raccoon boxes should be placed close to a permanent source of water. See the section on squirrel nest boxes for information on the placement of these boxes.

6. Check and clean the boxes (install new boxes) every

year before March 1. Replace the inside material if necessary. On wood duck boxes, be sure the lid fits tightly and is wired shut to prevent raccoons from entering the box.

7. Install predator guards to deter raccoons and other animals from eating and destroying the eggs and nest. Predator guards are essential and should be placed beneath all wood duck nest boxes. One way to discourage predators is to place a sheet of tin (Figure 3) around trees several feet below the box. For boxes placed over water, a cone-shaped metal guard (Figure 7) protects nest boxes from predators. The predator guards should be built of 26- to 32-gauge aluminum or galvanized sheet metal. The cone-shaped guard should be held together with #6 sheet metal screws,  $\frac{1}{4}$  inch round-headed stove bolts, or pop rivets and attached to the post with  $1\frac{1}{2}$  inch roofing nails. The cone-shaped predator guard should be placed 36 inches above the water's surface.

8. The double compartment wood duck nest box is similar in design and construction to the single compartment box. You can build a double compartment wood duck nest box following the plans outlined in Figure 8. The box can be built from one piece of 1-inch lumber 12 inches wide and 18 feet long. Follow the instructions for placement, maintenance, and predator guards described in the previous paragraphs.

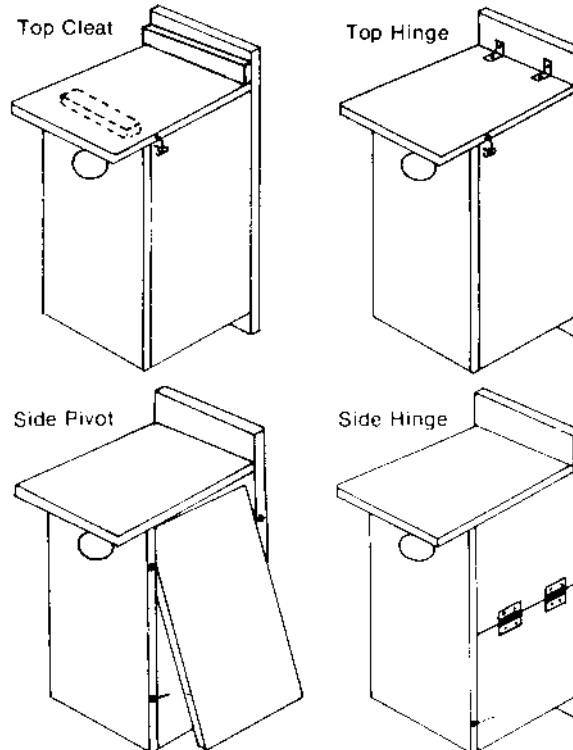

Figure 4. It is essential to provide easy access to nest boxes for maintenance. Four design variations commonly used are the top cleat, top hinge, side pivot and side hinge.

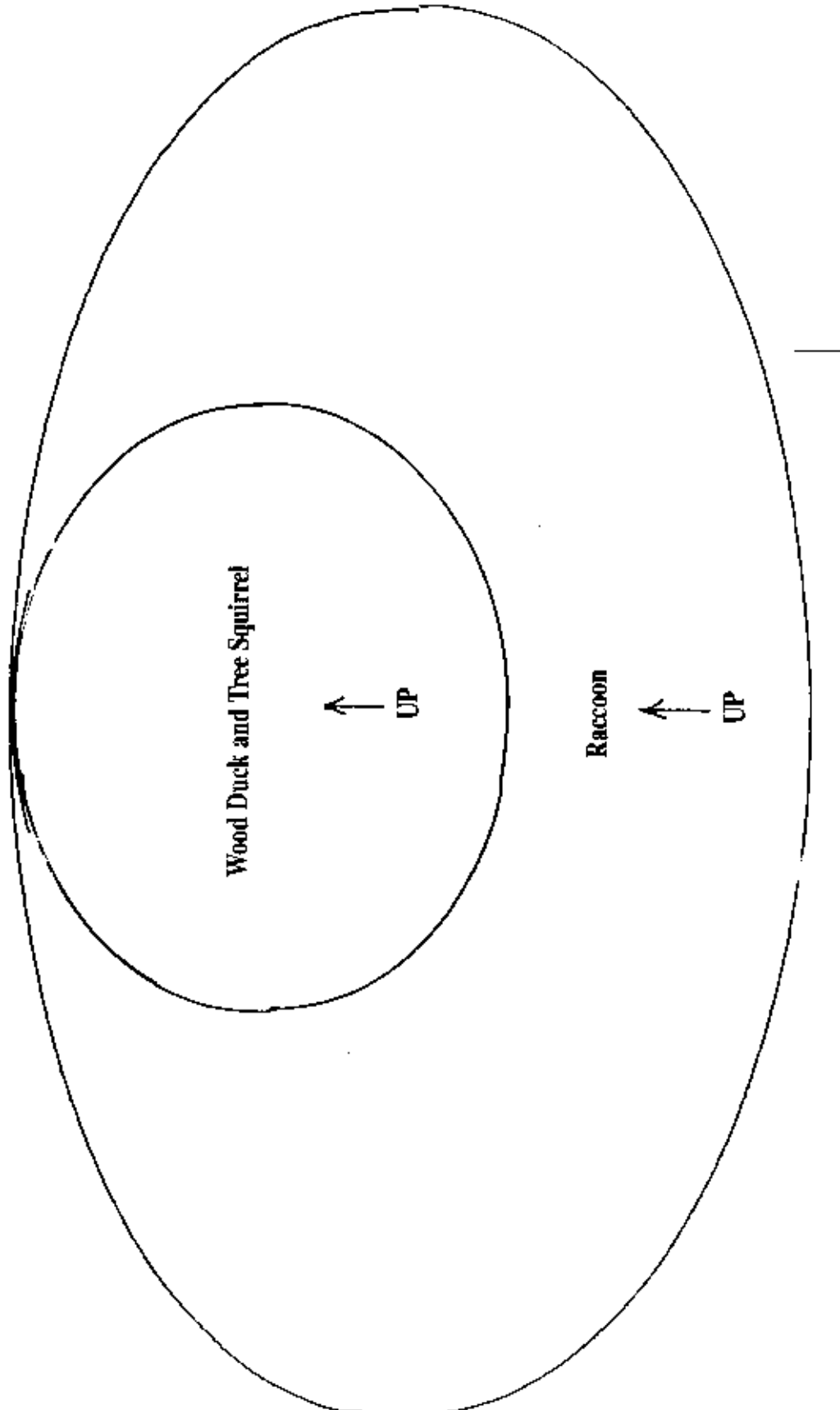

Figure 5

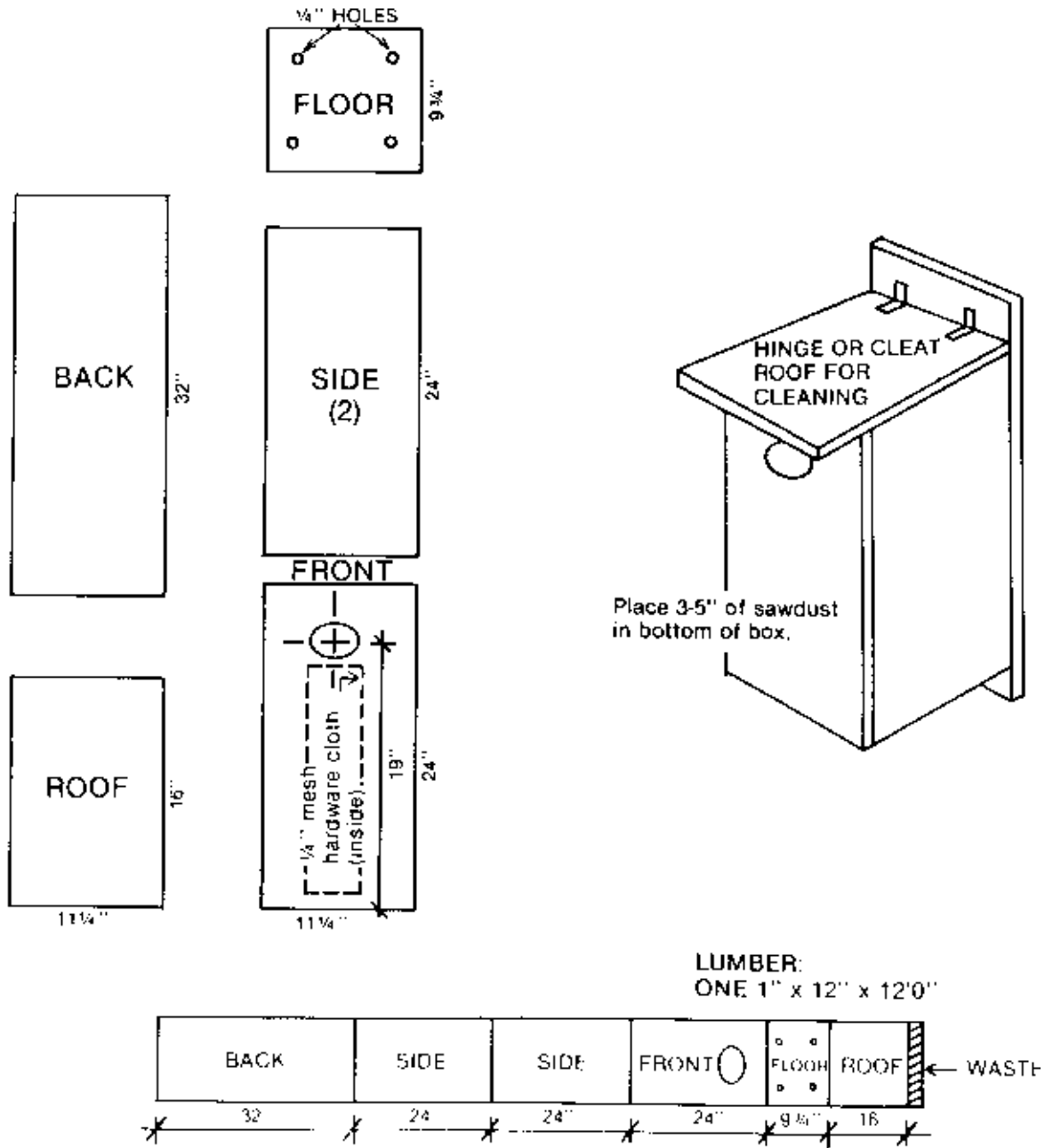

Figure 6. Sufficient lumber for one single-compartment nest box is contained in a 1-inch x 12-inch x 12-foot board.

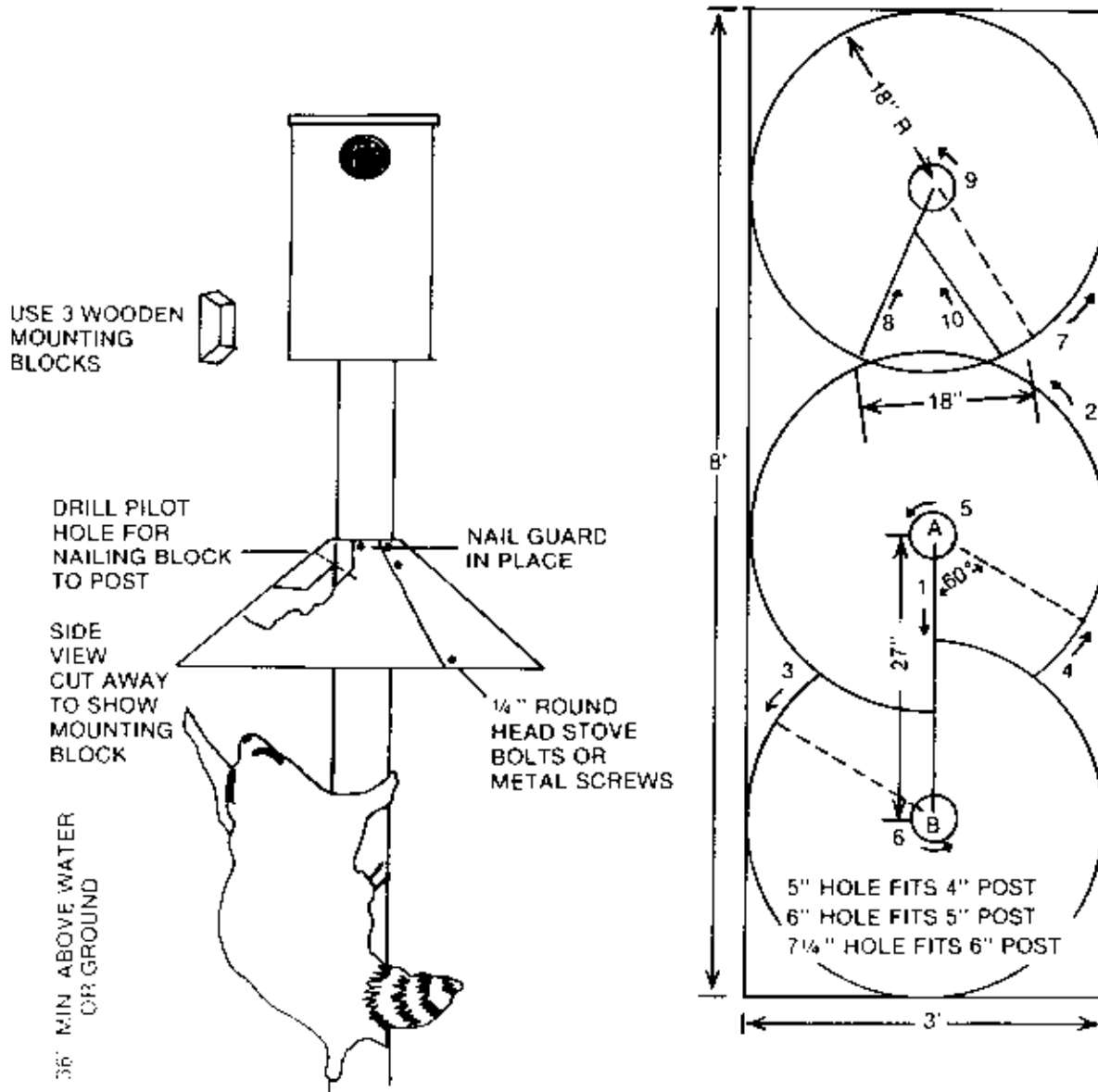

Figure 7. The cone-shaped sheet-metal predator guard offers protection from ground predators.



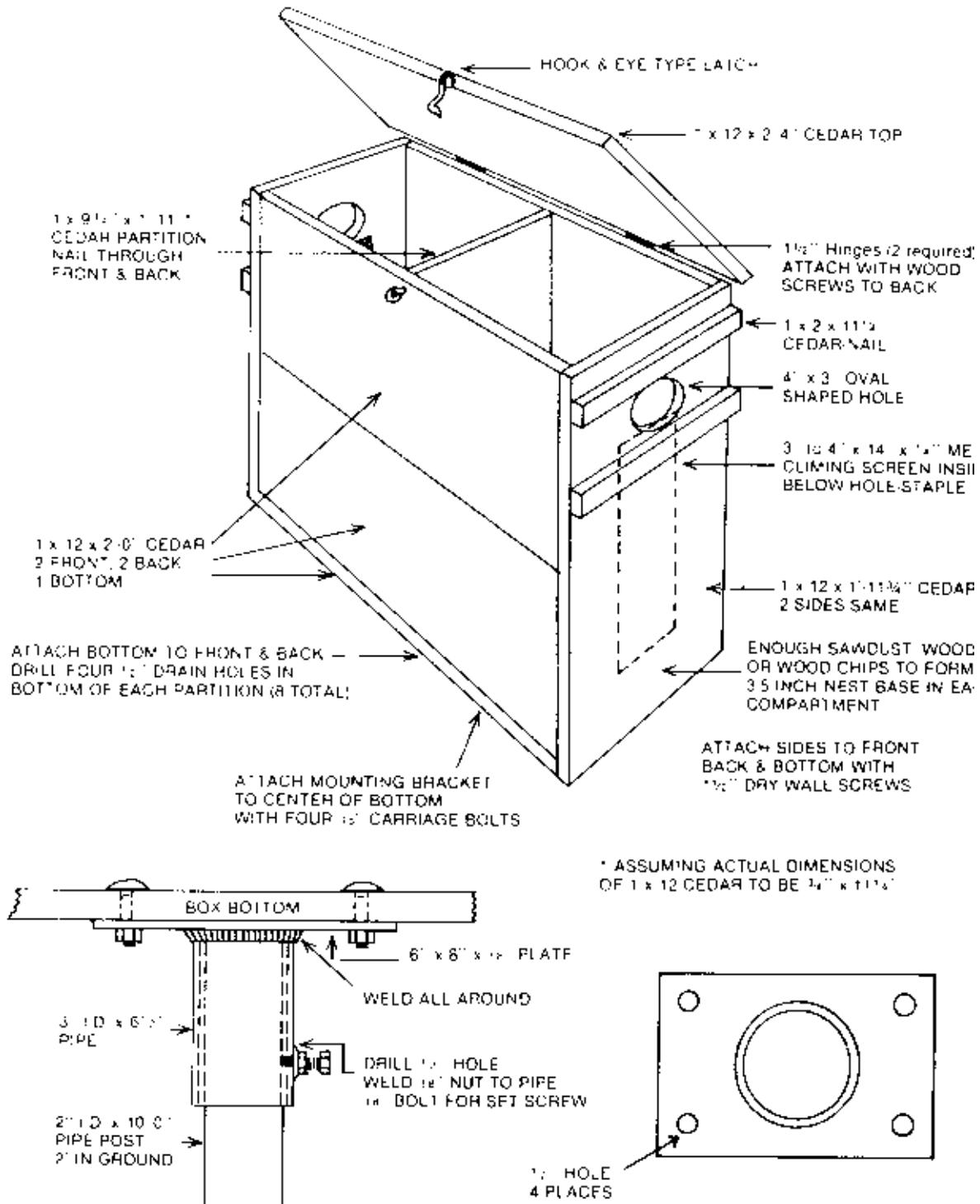

Figure 8. The double-compartment wood duck nest box is similar to the single-compartment wood duck box. If properly placed and maintained, it can double the wood duck production potential of an area at less cost.

### Mourning Dove

1. Construct the nesting cone from  $\frac{1}{4}$  inch or  $\frac{1}{2}$  inch hardware cloth following plans outlined in Figure 9. You can also build a nesting cone of composition asphalt shingles (black side up).
2. Place the cone 6 to 10 feet above ground on a tree with considerable open space available around the cone. Good choices for placing a nesting cone include urban or suburban areas or in trees along the edge of woodlands or other forested areas.
3. Make sure the cone is placed in a somewhat shaded area that is not blocked by numerous twigs or limbs so the dove can move about freely. Attach it to a tree with roofing nails, staples, or wire and bend the edges down slightly after it is in place.

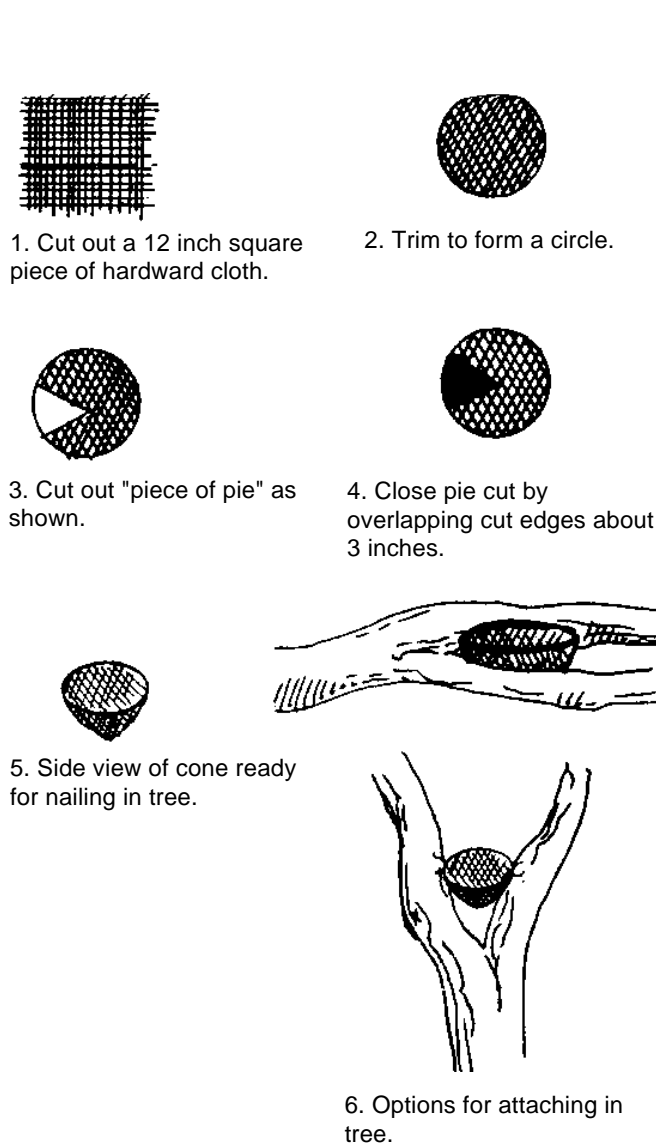

Figure 9. Nesting cone for mourning dove.

### House Wren

1. Construct the nesting box following plans outlined in Figure 10.
2. Wren houses should be placed 5 to 10 feet above ground. They can be located under the eave of a building or in a tree. This is the only bird house that can be hung from wire on a tree.
3. Do not put a perch on the house because it will encourage house sparrows to use the box.
4. If you wish to attract chickadees and nuthatches, enlarge the entrance to  $1 \frac{1}{4}$  inches.
5. After the family of wrens leaves the house, clean it out immediately so another batch of young can be raised.

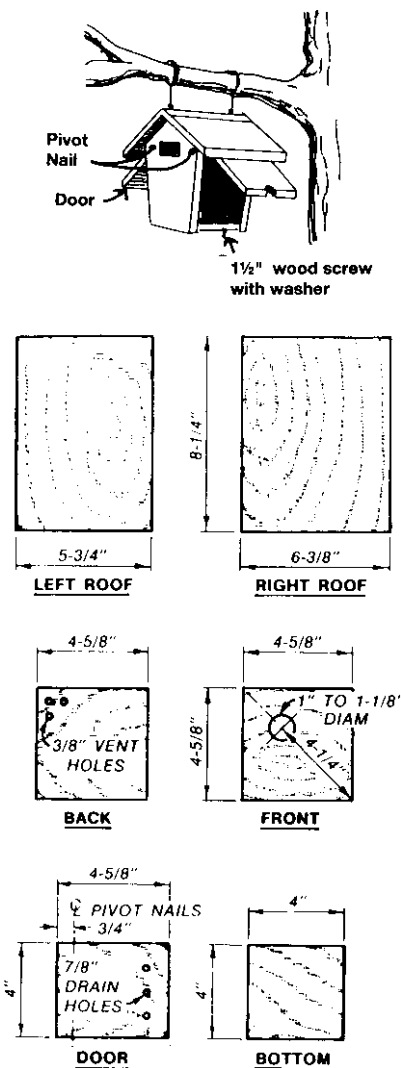

Figure 10. Wren houses can be constructed with either a round or rectangular entrance. Wrens often prefer a 1" x 3" or 4" entrance because it allows them easier access with long nest twigs.

**White-breasted Nuthatch, Carolina Chickadee,  
Tufted Titmouse, Prothonotary Warbler**

1. Construct the nest following plans outlined in Figure 11. The entrance hole size should be:
  - 1 inch for chickadees,
  - 1 inch for white-breasted nuthatch,
  - 1 1/4 inch for tufted titmouse.
- 2a. Nest boxes for chickadees, white-breasted

nuthatches, and tufted titmice should be placed along a tree trunk 5 to 15 feet above ground on trees located in smaller woodlots, along the edge of forest habitats, and close to woodland openings.

2b. Nest boxes for prothonotary warblers should be placed 4 to 8 feet above ground on a tree trunk located in bottomland hardwood forests or along rivers or streams.

3. Place about an inch of coarse sawdust in the bottom of the nest box designed for Carolina chickadees.

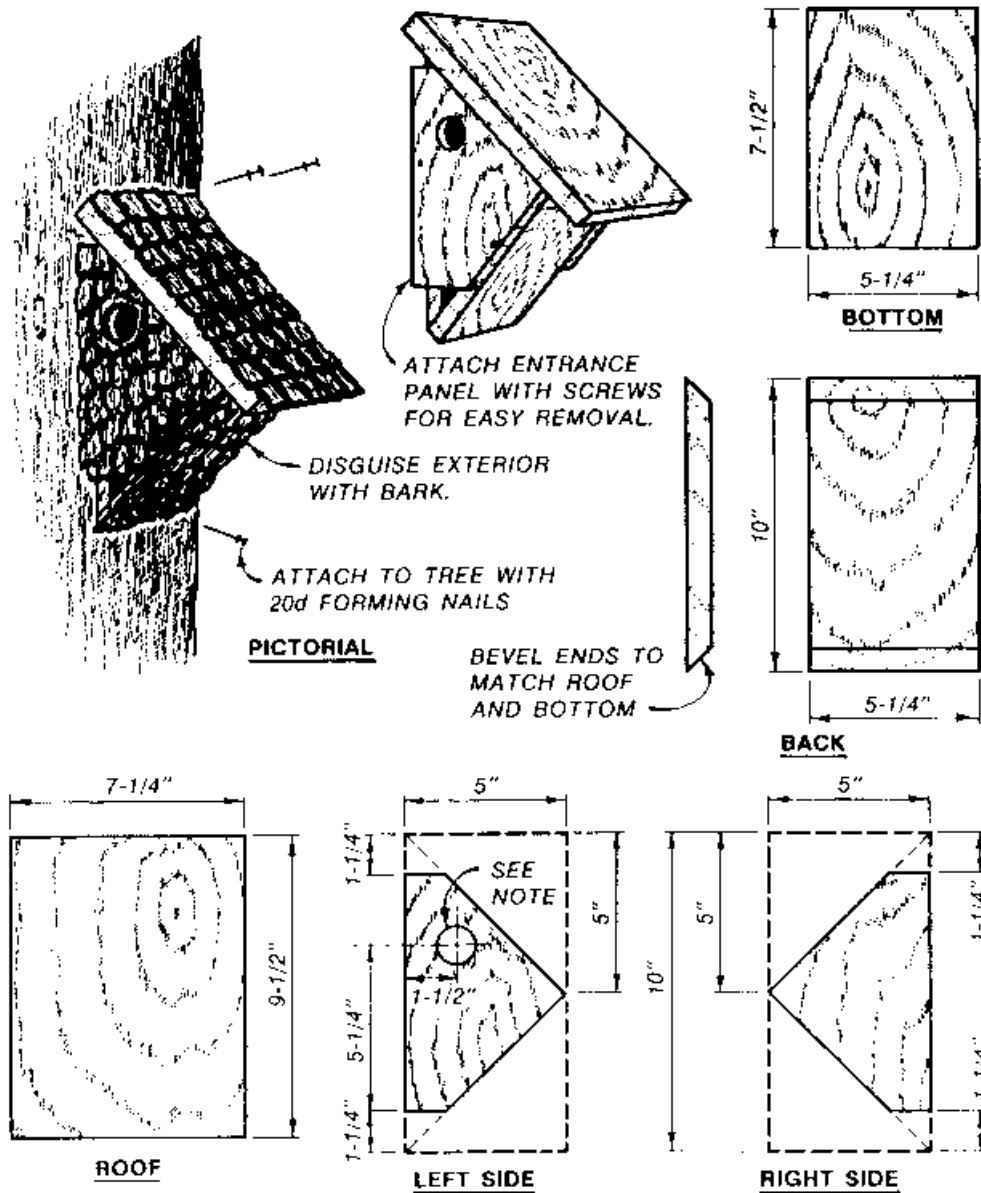

Figure 11

### *Nest Shelf for Robins, Barn Swallows, House Finches, and Eastern Phoebes*

1. Construct the nesting shelf following plans provided in Figure 12.
2. Place the nesting shelf 6 to 10 feet above ground on a tree trunk or the side of a building to attract robins. After the robins have raised a brood of young, remove the old nest because robins build a new nest (made of grass and mud) each year.
3. Place the nesting shelf under the eaves of the house to attract barn swallows, house finches, or eastern phoebes. The house should be near a permanent body of water (lake) to attract phoebes.

4. A small wooden strip placed across the front of the nesting shelf may help attract house finches and keep the nest from being destroyed by high winds.

5. If barn swallows already have a nest where it is undesirable, wait until after the first set of young have fledged and destroy the mud nest. Staple a piece of plastic over the area where the nest was located. This will prevent the swallows from getting the mud to stick. Place a nesting shelf in a desirable location 10 to 20' from the site of the original nest. This will allow you to enjoy the benefits of the swallows (their insect-eating capabilities) without their being a nuisance.

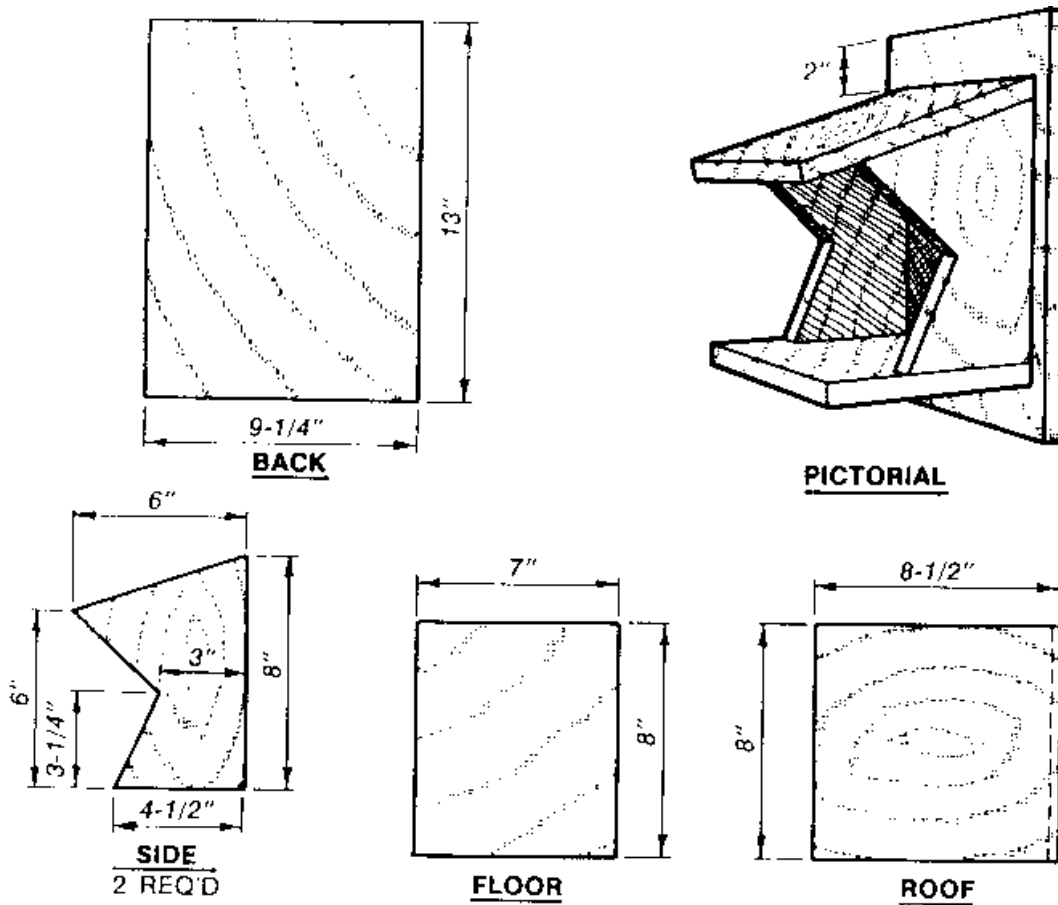

Figure 12



## Chapter 33

# Big Game Management

*Dale Strickland and Lee Wollrab*



The Great Plains of central North America are most often thought of as an important area for grain production and livestock grazing. Nevertheless, this area historically was the home of an abundance of large ungulates. Perhaps the symbol of the early plains was the American bison. Accounts of early travelers on the Great Plains include tales of millions of buffalo and hundreds of thousands of pronghorn antelope, mule and white-tailed deer, thousands of elk, and Audubon's bighorn sheep. As the plains were settled, market hunters began taking their toll and habitat was fenced and broken into relative small dryland farms, the bison disappeared, and the other game animals were greatly reduced.

Today, the dominant big game species occupying Kansas are the deer: white-tailed deer in the east and mule deer in the west. Pronghorn antelope remain in small herds in western Kansas and in other isolated locations.

Because of the land ownership pattern in Kansas, habitat for these species of big game is managed by a variety of individuals and the state. However, the vast majority of the surface is owned and managed by private individuals. Because private landowners are used to managing "their" piece of the plains, they sometimes do not relate to the management needs of a population of large mammals depending not only on their ranch or farm but also on the land managed by many of their neighbors.

The concept of herd or population units is very important for private landowners to understand. In some instances, habitat requirements of a population are randomly distributed over a fairly large area; and, thus, the animals are well distributed, and no one unit of land is more important than any other. More commonly, habitat components are irregularly or spatially distributed so that big game exhibits seasonal shifts in habitat utilization. In these instances, the habitat component in shortest supply can be considered key or critical to the survival of large numbers of animals. It is this key or critical habitat that requires the most attention when protecting or enhancing big game habitat.

## Antelope

The American pronghorn antelope has existed in North America for approximately 20 million years, occurring all across the Great Plains region from Canada to Mexico. Pronghorn numbers and distribution declined in the late 19th century with the advancement of the white man and his domestication of prairie land for various uses. With the approaching threat of extinction, changes in land use patterns and applied wildlife management practices have led to a partial recovery of pronghorn populations in the Great Plains region.

With the westward movement of settlers, antelope disappeared from much of their former range, and by 1910 they were restricted to the short-grass prairie. There were 1700 pronghorns in Kansas in 1980 and 1400 in 1993.

### *Habitat Requirements*

Pronghorn habitat is characterized by wide open rolling, expansive terrain with good visibility. Size of home ranges is dependent on the quality and quantity and interspersion of habitat characteristics. Although pronghorn transplants have taken place in Hawaii and Florida, it is the flat, open country of the Great Plains region where antelope continue to live and successfully reproduce.

### **Food**

Pronghorns are ruminants and require a mixture of grass, forb, and browse species for sustenance. The relative importance of these constituents depends on the season. A pronghorn's winter diet in western United States may be 80 percent browse, composed of mostly sagebrush (*Artemisia*

*sp.*), and the pronghorn's summer diet may be up to 86 percent forbs. Southern ranging pronghorns appear to use more forbs throughout the year than northern ones. In general, pronghorns prefer open rangelands supporting a variety of vegetative types over monotypic vegetative communities.

### Cover

Antelope have visual and locomotive adaptations to the open rangelands they occupy and generally prefer an average of 40 to 60 percent vegetative cover with an average height of no more than 18 inches. These adaptations and cover preferences provide the means for early detection and rapid escape from predators, while providing forb and grass species in adequate amounts for dietary requirements.

### Water

Considering the varying semi-arid rangeland that antelope inhabit, water intake can vary with the quality and quantity of succulent vegetation available as forage, total monthly precipitation, and average maximum temperature. Ranges supporting high pronghorn densities have available water every one to five miles, but animals may stray farther than five miles from water sources. When forage is succulent, 1 quart of water per day per animal is sufficient. Antelope water consumption may approach 2 gallons per head per day in very arid areas. In northern ranges, the availability of water during summer months is probably most critical as antelope obtain water from snow during the winter.

### Home Range

Home range is probably best determined by the habitat preferences and/or dietary constraints of the pronghorn, and may vary with environmental conditions. As water or forage sources are depleted, pronghorn are likely to be concentrated in areas that will support the population. In some cases, antelope have moved in excess of 150 miles in response to deep snows.

### Population Objectives as Habitat Management Factors

Pronghorns must be managed on the basis of area-specific populations. With such a mobile species, it will probably be impossible to manage pronghorns on individual ranch/farm units. Thus, management objectives must be agreed upon by all landowners within the range of a population.

### Management Practices

In the northern part of their range, antelope may change habitats seasonally depending on the location of key winter ranges. Even in the southern Great Plains, antelope exhibit limited seasonal movements. They move within large areas

of year-long habitat to take advantage of seasonally limited resources.

Antelope are very sensitive to range and highway fences. Some attempts have been made to mitigate the impact of fences by placing antelope passes, specialized cattle guards, and drop panels in fences. Antelope passes evaluated in several western states demonstrated only limited utility. Drop panels are effective if placed in fences at right angles to major antelope migration routes. The major disadvantage to drop panels is that they require people to drop them. All too often, panels are not dropped prior to winter storms when panels in remote areas are difficult, if not impossible, to reach.

In 1968, the Antelope States Workshop adopted fencing guidelines for antelope range. These guidelines should be followed in constructing fences on antelope range. In general, fences should be constructed with enough space between the ground and bottom wire to allow pronghorn to crawl under the fence (approximately 16 inches).

Key ranges usually determine the number of antelope a herd area will support. Key ranges usually include one or more of the following: (1) spring range, (2) winter range, (3) migration routes, (4) water source, and (5) fawning habitat. If these key ranges are available and fences do not hinder movements between these areas, antelope should prosper.

Antelope should be provided a diversity of vegetation, including grasses and forbs on spring and early summer ranges and shrubs on late summer, fall, and winter ranges. Total shrub cover normally should not exceed 30 percent canopy cover. In the southern Great Plains, where forbs persist for much of the summer, shrub cover on antelope range can be reduced to as low as 10 percent and still provide good habitat. This type of range condition is provided by a sub-climax successional stage on the Great Plains. Historically, this sub-climax was maintained by wildfire and seasonal grazing of herbivores, especially bison. While these natural influences on range condition have all but disappeared, these same conditions can be created by using livestock grazing, controlled fire, and herbicides.

The following discussion on management practices is taken primarily from Robert E. Autenrieth (*Guidelines for the management of pronghorn antelope*, 8th Pronghorn Antelope Workshop, 1978).

*Brush Control:* Efforts at brush control on antelope range must consider antelope requirements. The control of brush on antelope range can be beneficial when the brush canopy cover exceeds 30 percent, especially when the majority of the plants are tall (30 inches). Any efforts at control should be directed at increasing patchiness of vegetation types. Individual control sites should be irregular in shape and no larger than 1,000 acres. Brush cover on spring and summer range should be maintained at 5 to 20 percent canopy coverage. Shrub cover on fawning areas

should be maintained at a canopy cover of 20 to 30 percent.

Mechanical means of brush control, such as plowing, chaining, or chopping can be used. Plowing can result in the loss of native plants, and disturbed soils may be dominated by invaders. Chaining and chopping are less damaging to native forbs and grasses, and shrubs, such as sagebrush, are not completely removed. All mechanical methods are very energy intensive and thus expensive.

Chemical control of sagebrush is a common practice on native ranges in the Great Plains. The chemical (normally 2,4-D) reduces sagebrush and forbs but has no effect on grasses. And, reduction in forbs is usually temporary. If chemicals can be used very early in the spring, partial control of sagebrush can be accomplished with minimal effect on deciduous shrubs, such as antelope bitterbrush, and forbs. Chemical control should be used with care to avoid damage to riparian and other nontarget habitats.

Controlled or prescribed burns can be used to control shrubs with minimum damage to grasses and forbs. Burning results in the removal of large shrubs, old dense stands of shrubs and an increase in soil fertility, forb and grass production, and palatability. As with other control methods, burns should be designed to create a mosaic of vegetation types and should avoid damage to nontarget habitats.

The dominant use of Great Plains rangeland is cattle grazing. As mentioned previously, cattle grazing can be compatible with antelope management and can even be beneficial if done with antelope habitat requirements in mind. Compatibility between cattle grazing and antelope depends on stocking rates, season of use, and forage condition. In general, dual use of ranges by antelope and cattle is most compatible on range in good condition. Many range conservationists have recommended that, as a rule, forage utilization should be limited to 50 percent of current growth.

*Spring use:* Spring ranges should be used only lightly, usually 25 percent of current growth. Additional use of spring pastures can occur in summer and fall periods.

*Summer use:* Summer use often is concentrated in more moist sites. Livestock use of summer pastures should be spread over the entire pasture as much as possible, through the distribution of water and salt. If grazing pressure on moist sites becomes excessive, protective fencing should be used.

*Winter use:* In most of the Great Plains, winter range is the most critical habitat. Grazing of winter range by domestic stock at any season of the year can be detrimental if it is excessive. Antelope food preference overlaps considerably with sheep on winter ranges, although cattle on heavily used ranges will use shrubs extensively. Key winter ranges should be grazed only during spring and summer periods by either cattle or sheep and then only moderately.

Montana reports good success in protecting antelope range with the use of rest-rotation grazing systems. How-

ever, the extensive fencing associated with this system can create barriers for antelope movement. If the restoration system is used, the layout of pasture systems can be critical. Key habitats should never be managed as a single pasture.

The grazing system seems to be of limited importance. Any system should be compatible with antelope as long as important antelope habitat components are maintained, and antelope movements are not unduly constrained.

Water, more than any other factor, has influenced antelope distribution in the more arid areas of the Great Plains. In eastern Wyoming and Montana, the development of water for livestock has created ideal summer and fall antelope range where water was previously a limiting factor. At present, water quantity does not seem to be a problem. However, in cases where additional water is needed, a permanent water source, such as a well or spring, is preferred over the more temporary catchment basins or guzzlers. Guzzlers may be effective but require considerable maintenance which is expensive and time consuming.

Little is known about water quality needs of antelope. Antelope occupying desert habitats have used water with total dissolved solids (TDS) of slightly over 4,600 ppm. In general, water quality standards acceptable for livestock are adequate for antelope.

### *Land Use Changes*

Much of the historical range of antelope in the Great Plains have been lost due to the conversion of native rangeland to cropland. Recently, additional habitat has been lost to mining. The conversion of native rangeland to crops is detrimental to antelope and should be discouraged when the profit is marginal.

The most critical impact occurs when land use changes in the loss of key habitats. These habitats should be protected as vigorously as possible. When protection is not possible, reclamation will determine the extent and duration of the impact.

*Reclamation:* When reclaiming disturbed land for antelope, determinations must be made as to whether the site is seasonal or year-long range. For example, available water is much more critical on a year-long range than on areas used as winter range only. Once the determination is made regarding the status of the region in question, it becomes essential that all of the basic requirements are included.

*Water:* Because of the arid areas where they live, water can be more critical to antelope than other species of big game. In many regions, the amount, quality, and distribution of available water during mid- and late summer is critical to fawn survival and may directly influence overall herd productivity. Responsible involvement in planning mining activities and reclamation can protect and maintain existing water sources and also provide additional ones.



Animal distribution, fawn survival, and forage utilization can definitely be improved through the development of small strategically located sources of water. More antelope could be better served if a number of small watering ponds were provided rather than one or two large lakes. However, care should be taken to ensure that the ponds have some permanent source of fresh water. Developed water areas should be periodically monitored for water quality.

*Fencing:* Fencing antelope range can be disastrous. The most ideal situation is no fencing. This option is not always practical; for in some instances, fences will be needed. Toxic water ponds (evaporation ponds) and storage areas, for example, may need antelope-tight fences to reduce or prevent mortality. The least restrictive type of fence would be a three- or four- wire fence with the bottom wire being smooth and a minimum of 16 inches from the ground. Advance planning to document important movement routes is essential.

*Cover:* Vegetative cover type, topography, climatic conditions, and predation should all be considered when interpreting the cover needs of antelope. To avoid predators, antelope rely on their ability to achieve high sustained speeds. To facilitate escape, unobstructed open terrain is desirable. During periods of adverse climatic conditions, which may include cold or hot temperatures, high winds, and snow, lee sides of rolling hills or the taller forms of some shrub species, such as big sagebrush located along intermittent water sources, can be of great value as cover for antelope. During the critical fawning period, the mosaic patterns of different size and growth forms of shrubs are important. Areas containing abundant amounts of plains prickly pear cactus are important hiding places for fawns while the doe is foraging.

Generally, cover requirements for antelope are probably less specific and less critical than for deer. When preparing a reclamation plan for antelope, consideration should be given to restructuring of mined areas into gentle slopes, saving natural stands of taller browse, and shrub mosaic patterns where they may exist as well as fawn placement sites.

*Forage:* Areas where antelope preferentially feed, regardless of the season, should be protected from development. Where development is unavoidable, these general steps should be taken when reclaiming these lands:

1. Evaluate the site's suitability for revegetation and for restoration of topographical features.
2. Identify species and varieties of both native and introduced plants that establish readily and yield forage of satisfactory quality and quantity for antelope.
3. Select a mixture of species including browse plants, forbs, and grasses. Conduct plantings using adequate seeding rates and/or adequate numbers of seedlings.
4. Obtain high-quality seed or propagation stock and plant in well-prepared sites using satisfactory planting

techniques. Many times, seed collected from the area is more adapted to the environment of that particular site than is seed of the same species brought in from other sources.

## Mule Deer

Mule deer are extensively distributed over much of the western half of the United States. While the mule deer is most often associated with the more mountainous states (New Mexico, Colorado, Wyoming, and Montana), every plains state has populations, including Kansas.

### *Habitat Requirements*

Mule deer are highly mobile animals, but for most areas in Kansas, they establish definite year-long home ranges. These home ranges may vary from a few hundred acres to over 1 square mile. The size of the home range and thus the density of deer depends on the abundance of various habitat components. Adequate and well-distributed food, cover and water are the essential components of mule deer range.

*Food:* Mule deer are ruminants, thus having the ability to digest a variety of plant materials. However, because of their small size, mule deer require a higher quality diet than larger ruminants, such as elk and cattle. Mule deer are normally considered browsers, although plant selection depends on availability, the stage of plant development, palatability, and season. Mule deer feed on the current annual growth of palatable woody species year-round. In the early spring, succulent grasses and early developing forbs are heavily utilized. During the late spring and summer, abundant forbs are an extremely important component of the diet. As forbs and grasses mature and dry up in the late summer and early fall, leaves and twigs of deciduous shrubs dominate the diet, continuing through the fall and early winter. In deer range where deciduous shrubs are uncommon or where use is heavy, the winter diet gradually shifts to shrubs with persistent leaves.

Farm crops may provide a seasonal source of forage for mule deer. In extensively farmed areas, such as parts of Kansas, crops may comprise a significant proportion of the mule deer's year-long diet. In other areas, crop utilization depends on availability and succulence (e.g., winter wheat during winter and spring and alfalfa during the spring and early summer).

The importance of proper diet for the maintenance of a mule deer population is best illustrated by this discussion from Short (1981):

"Summer forage should allow adequate milk production by does and permit all deer to achieve adequate growth and fat storage. Autumn forage should be abundant and of good quality to delay the depletion of fat stores. Winter range should provide forage that minimizes energy deficits and fat depletion. Spring range should offer feed that permits early recovery from stresses of winter. Thus, all ranges are

important to deer and must be managed carefully to provide quality nutrition in order to maintain healthy and productive deer populations.”

*Cover:* Mule deer require cover for escape from predators, shelter from the elements, and to ensure a sense of security.

Deer, unlike antelope, have not evolved the ability to escape predators through extended high speed maneuvers but rather through quick dashes to rough terrain and dense vegetation. Thus, feeding deer rarely venture far from a draw full of tall brush, a pile of rocks, or thicket of large shrubs or trees. A mule deer fawn is highly susceptible to predation the first week of its life, and does usually choose an area of dense shrub cover, often at the edge of a timber stand or thickets, as a fawning ground.

The natural environment can be very harsh in the Great Plains. Deer must seek protection from cold temperatures, high winds, and snows in the winter and heat and insects in the summer. Thick vegetation, such as juniper, gives protection from the wind, which decreases body heat loss. Large shrubs provide cover from wind and snow during a winter storm. Following the storm, snow in dense shrub stands remains fluffy and is less of an obstacle to deer movement and feeding.

Topographical features, such as scattered boulders, gullies and draws, lee sides of ridges, and rimrocks, also provide deer cover. Rimrocks are favored resting spots where deer may be seen lying in the shade during hot summer afternoons inspecting the surrounding terrain.

While topographic features provide important cover for mule deer, cover associated with adequate forage is essential. Thus, brushy draws, rimrocks with brush, small stands of trees, and boulder-covered ridges interspersed with brush and small trees are ideal mule deer cover. Flood plains with thick stands of cottonwoods and willows also provide suitable cover. Topographic diversity is important cover; moreover, this diversity also provides north- and south-facing slopes. North-facing slopes provide cool microhabitats for resting during warm periods, while south-facing slopes provide snow-free winter feeding sites with escape cover just over the ridge.

*Water:* Perhaps the most important element of water or the lack of it to mule deer in the Great Plains is its importance to woody vegetation. Periodic droughts in parts of the Great Plains can result in loss of significant amounts of woody vegetation. As cover is reduced, deer distribution may be altered as animals concentrate their feeding on sites close to remaining cover. This can result in overuse of the feeding sites and reduced capacity for the area to support deer.

In severe drought conditions, lack of free water can be a serious problem for deer. Free water is most important to deer during the late summer and fall periods when vegetation has matured. The home range of mule deer will

normally include a source of free water, such as a natural spring, seep, stock pond, stock tank, or perennial stream.

### *Management Practices*

The first step in managing mule deer and their habitat is the establishment of an objective for the deer population. Because mule deer habitat in the Great Plains is primarily privately owned, this objective-setting process must involve the landowner(s). If the objective for a particular population is maintenance of present numbers, then management must be directed at preventing population increases and the loss of habitat. Inventories must identify current levels of habitat components, and management must ensure the maintenance of minimum levels of these components.

If the objective for a population is to increase numbers, then inventories must identify the limiting resource. Management strategies for maintenance of habitat components most often will involve preventive measures. Management strategies for improving some habitat component will likely involve more inventive and cost-intensive practices.

The habitat feature most limiting mule deer distribution and numbers in the Great Plains appears to be cover, specifically draws with dense stands of hardwood trees and shrubs, narrow flood plains with cottonwood, and associated rough terrain. However, shortage of vegetative cover may not be limiting on most of the southern Great Plains. On the other hand, too much cover may be a limiting factor in the far southern and southwestern parts of the range. The most common factors affecting these habitats are drought, uncontrolled fire, and overgrazing by domestic livestock. Less common historically, but equally as detrimental in recent years, has been the conversion of rangeland to cultivated land and the loss of habitat to coal mining and oil and gas production.

*Drought:* Little can be done about drought, but management can be important in determining its severity on mule deer habitat. Vegetation will be less affected by drought if it enters the dry period in good condition. Subsequent discussions on grazing should provide insight to management practices which will improve the drought tolerance of mule deer habitat.

*Grazing:* The Great Plains are primarily private lands with scattered tracts of Federal lands. One of the primary uses of these lands continues to be livestock grazing. Continuous livestock grazing has resulted in deteriorated mule deer habitat, particularly hardwood and shrubby draws and cottonwood dominated floodplains. This deterioration has resulted from increased erosion, soil compaction, and overuse of the herbaceous understory, reducing forage and cover for deer and eliminating young trees and shrubs necessary for stand perpetuation.

Many ranchers in the Great Plains realize the value of brushy cover to their livestock as protection from summer

heat and the violent winter storms. Thus, an education program explaining the value of cover to livestock as well as wildlife should be valuable. Management practices directed at the control of livestock distribution, season of use, and stocking rates appear to be the most viable solution to the problem of overgrazing.

Montana has had excellent success in controlling livestock overuse through the implementation of Hormay's restoration grazing system. In this system, pastures could be designed to rest important deer cover sites from one to three years. However, rested pastures are used intensively when they are used, and rest periods sufficient for grass to recover from heavy grazing may not be long enough to allow shrubs to recover. Heavy use can also result in soil compaction. In situations where woody vegetation is deteriorated, total protection may be necessary for recovery. Livestock distribution can also be controlled through the careful placement of salt and new water developments.

Most grazing systems depend on extensive fencing. It may be necessary to fence relatively small areas of deer cover to protect it. In addition to costs, fencing can present problems to other wildlife, particularly pronghorn. In pronghorn habitat, fences should be constructed according to the specifications presented in the discussion on the management of pronghorn habitat.

Planting of shrubs and trees may be necessary in seriously deteriorated areas. In these situations, seedbed preparation, reseeding, and planting with nursery stock may be necessary, along with cultivation and fertilization until the trees and shrubs are established.

*Fire:* Uncontrolled fire can result in the loss of valuable mature stands of hardwood trees and brush. Controlled fire can reduce competing grasses and stimulate growth of fire-tolerant species, such as buffalo berry, ponderosa pine, snowberry, willow, and rose. Cool fires used during late fall and early winter will likely produce the best results. The fast-growing herbaceous vegetation which develops soon after a fire, will attract livestock to burned areas, so total protection from grazing may be necessary until young shrubs and trees are large enough to tolerate use.

### ***Range Conversion and Energy Development***

The prospect of preventing development or conversion of native rangeland so that deer habitat may be protected is not bright. Usually the stimulus behind range conversion and energy development is financial gain. At the very least, landowners and energy developers should be made aware of the location of key mule deer habitats. They should also be made aware of the trade-offs, both economic and environmental, associated with the loss of these habitats. If options are available, the landowner may choose to protect those habitats most important as cover and forage for mule deer.

If deer habitat overlays coal or oil and gas, it is likely to be lost. The period of loss will depend on reclamation

efforts. Surface owners should be encouraged to include mule deer in post-mining land use objectives. Reclamation should include suitable species of plants as well as topographical diversity.

## **White-Tailed Deer**

White-tailed deer inhabit every county in Kansas. When man first began to settle the land, cutting of trees led to an increased abundance of deer forage (browse species), and deer populations flourished. Later, market hunting, lack of game laws, and further agricultural development decreased the whitetail population below 500,000 in the late 1800s. The deer that remained, survived in isolated and protected habitats. Forest rejuvenation programs, better management practices, successful reintroductions, public awareness and support, and the animal's innate adaptability to changing environments have helped increase white-tailed deer populations.

*Food:* White-tailed deer are primarily browsers. They feed on the tips of twigs, branches, and new shoots and leaves of selected shrubs and trees because these parts are the most nutritious, most palatable, and easiest to bite off. Depending on the region of the Great Plains, deer diets range from 40 to 60 percent woody plants. Forb species are an important diet component during the spring and early summer, making up as much as 50 percent of the diet in some areas. In the Plains states where agriculture is widespread, farm crops provide an important source of food. It is estimated that the diet of deer in Kansas consists of from 50 to 60 percent farm crops during the fall and winter.

In general, succulent vegetation is used in the spring with a shift to browse during the summer and fall months. Acorns, fruits, and cultivated crops are also used in the fall, and evergreen browse is important during the winter. Grass and grass-like plants are utilized when they are green but comprise only a minor part of the diet. Naturally, diet changes may occur as forage availability increases or decreases with environmental fluctuations.

*Cover:* Both thermal and escape cover are important to deer. They will usually remain within a one-quarter mile radius of cover patches, even when feeding. In the Plains areas, where cover is scarce, whitetails concentrate in small groups close to available cover. In the summer months, deer move out of these concentration areas but will not usually be found further than 400 yards from cover. Whitetails are most abundant in the Great Plains along creeks and rivers where elm, ash, cottonwood, hackberry, oak, and boxelder are common overstory.

*Water:* Throughout the Great Plains, white-tailed deer inhabit areas where water is available and will change ranges when water becomes unavailable. In general, water availability is not a problem to whitetails on the Great Plains. In the summer, 2 to 3 quarts of water per day are

required for each 100 pounds of body weight, while in the winter, 1½ quarts per 100 pounds of body weight per day are required.

*Home Range:* A deer's home range will vary with age, sex, season, and availability of forage. Estimates of home range size vary from 1 to 12 square miles and deer will expand or contract their range as forage becomes available or scarce, respectively. As with many big game species, environmental fluctuations can and do alter an animal's habitat use patterns.

### ***Management Practices***

While the possible rate of increase in deer herds is surprisingly high, this rate is seldom reached. Many factors, chief among which is man, tend to hold numbers down. In order to successfully manage deer populations, the following factors should be considered:

- (1) Key areas of habitat
- (2) Size and distribution of cover
- (3) Direct habitat improvements
- (4) Habitat influence on other associated wildlife
- (5) The landowner

*Key Areas:* Wooded and brushy riparian areas represent the most important white-tailed deer habitats in the Great Plains. Thus, the management of these areas is extremely important to the maintenance of healthy populations of whitetails. Agriculture has been the most important man-associated activity affecting whitetails in the past. The expansion of agricultural crops into native grasslands and woodlands may have increased the ability of the Plains to support deer. However, management of riparian habitat has had the opposite effect. The conversion of wooded river bottoms to agricultural crops, and the heavy grazing of the remaining native riparian areas has caused deterioration of some whitetail habitat.

*Size and Distribution:* White-tailed deer need cover for security from predators and disturbance. Thermal cover is also important in maintaining body temperature. Hiding cover may be provided by dense stands of brush, while thermal cover usually requires coniferous or deciduous cover 5 feet tall or taller with a 75 percent canopy.

Patches of hiding cover should be from 6 to 25 acres or more in size. Thermal cover should be in patches of 2 to 5 acres minimum. As a general rule, deer range should have a minimum of 30 percent cover and 70 percent foraging areas.

*Direct Improvements:* As with all other wildlife species, the best management for key areas in the case of white-tailed deer is protection of woody cover.

In the case of deteriorated range, there are several habitat management practices that can benefit white-tailed deer. The following is a list of management practices applicable to private lands:

1. Develop or maintain woody cover. If you have

mature stands of woodlands, consider a timber management program that results in selected harvest or culling of some trees. This will open up the tree canopy and allow understory vegetation (forbs, shrubs, and grasses) to become established. In developing new woody plantings, consider species that have economic as well as wildlife values. Incorporate low-growing, woody species along field borders.

2. Create edge and interspersed cover types. Encourage those stages of natural succession that provide an abundance of deer browse and forage. Periodic mechanical disturbance, such as cutting or using a brush-hog and use of controlled fire, can help to maintain desired species composition and densities. Natural variations in topography can be used effectively. Either maintain existing plants or establish new clumps of low-growing, woody species with occasional larger-growing trees added. Fruit and nut producing species are particularly desirable.

3. Fence all or selected portions of woodlands to eliminate grazing. Brushy, ungrazed draws leading from bottomland timber into adjacent pastures provide excellent habitat.

4. Plant small (.5 to 3 acres) corn and sorghum food plots in the immediate vicinity of deer wintering areas to supplement natural foods. Green winter wheat, alfalfa, and sweet clover are heavily used by deer.

5. In pasture areas, protect clumps of existing woody vegetation. These are normally associated with hillsides, draws, intermittent streams, and other "odd areas." Perimeter control of invading woody plants can be accomplished by mechanical means through use of controlled burns or by selected use of herbicides.

6. Establish a grazing program that maintains grassland vigor and quality. In the end, it will benefit both livestock and deer.

7. Do not fall plow agricultural lands associated with deer wintering areas, because this destroys nutritious crop residues.

In addition to the above suggestions, prescribed burning can perpetuate early stages of succession. Prescribed burning can rejuvenate woody understory plants while protecting trees in the overstory.

*Influence of White-tailed Deer Habitat Upon Associated Wildlife:* Maintenance of white-tailed deer habitat in Kansas assures habitat for other species depending on early successional woodlands and riparian areas. This includes more than 300 species of songbirds and dozens of species of small mammals.

*The Landowner:* In Kansas, where most of the land is privately owned, the landowner's ability to control hunter access is of paramount importance. Private landowners should assist wildlife managers in maintaining deer numbers at objective levels by allowing access during the hunting season; and by the same token, land managers must avoid

providing too much access in important deer habitats. Sound management thus implies reaching an optimum equilibrium between landowner tolerance of hunters during the season and the number of deer inhabiting the land year around.

### **Summary**

White-tailed deer management involves planning for and understanding the population, deer habits and habitat, landowner preferences, and the socio-economic benefits the resource provides to the public. Poor information or a communication breakdown may be detrimental to the resource, which man is trying to manage.

## **Elk**

The North American elk has been well-known since the westward movement of man. Many historical accounts tell how elk, or wapiti, roamed freely with the bison. As man began to settle areas of elk winter range in the latter 1800s, however, elk populations began to dwindle and many became extinct. Now, because of regulated hunting, propagation and translocation programs, elk have increased and inhabit portions of their historical ranges. This recovery onto historic ranges has included small herds in Kansas.

### **Habitat Requirements**

It is generally assumed that with adequate cover, water, and space, physical herd condition will relate directly to forage quality and quantity. Since elk spend 90 to 95 percent of their day foraging and resting, food seems to be a very important habitat requirement.

Elk are primarily grazers, with up to 85 percent grasses in their spring diet, although they are opportunistic and will alter their diets as grasses and other forage becomes unavailable or unpalatable. Basically, elk feed on grasses in the spring, forbs, agricultural crops, woody plant twigs, and leaves in the summer, dried grass and browse in the fall, and browse plus available grass during the winter.

Cover is related to food in that elk utilize cover for thermal protection to help maintain their body temperature. Elk seek various stands of cover in response to changing

environmental conditions. Besides escaping high and low temperature extremes, elk have been known to avoid rainfall by entering dense timber stands. Stands with a dense understory provide greater protection from winter winds and summer heat.

Water is metabolically important to all warm-blooded animals. Throughout most of the year, elk are found between one-third and one-fourth miles from water sources. Only lactating cows seem to show a seasonal dependency on water, and snow is utilized during the winter, while available succulent vegetation helps to satisfy water needs during the remaining months.

*Home Range:* Elk are sometimes forced to change their home ranges in response to human development, competition with other species for preferred habitat, or changing weather conditions. Therefore, it is difficult to give a universal definition for an elk's home range and must be considered on a site-specific basis.

### **Management Practices**

*Key Areas:* Throughout most elk range, the factor controlling elk use of feeding habitat is the availability of some dense stand of tall vegetation associated with suitable feeding habitat.

Because of elk dietary preference, food is usually not a limiting factor in Kansas. Nevertheless, the similarity of cattle and elk diets make these species potential competitors for food. Conflicts may also occur when elk herds forage in crop fields.

*Direct Improvements:* Little in the way of short-term improvements can be made for elk in Kansas.

### **Influence of Elk Management Upon Associated Wildlife**

Maintenance of elk habitat in Kansas assures habitat for a variety of other species. This includes raptors, such as red-tailed hawks, goshawks, and sawwhet and great horned owls, as well as a great number of songbird species. Because of their generalistic food habits, elk can compete with deer when occupying common winter ranges.





## Chapter 34

# Tree Squirrel Management

Jeffery D. Sole

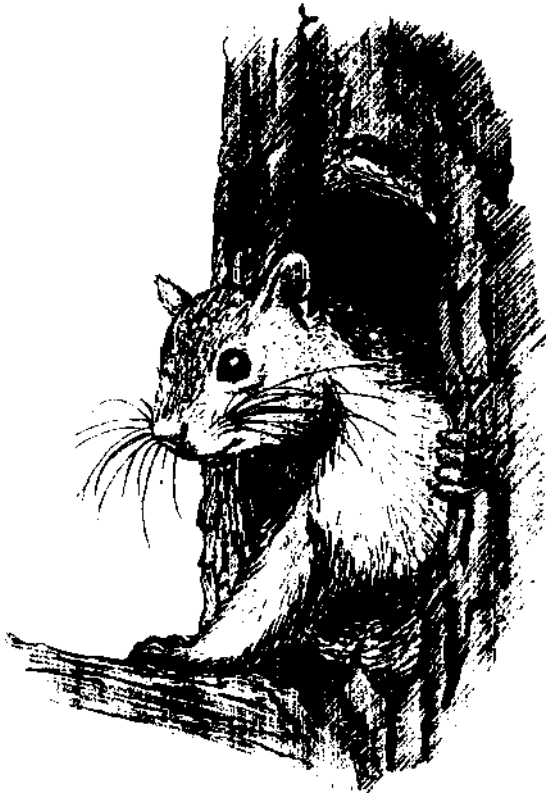

Tree squirrels at one time were the number one game animals in eastern Kansas. They also rank high as a species enjoyed by appreciative nature lovers, who may make a habit of feeding squirrels in their yards, much to the dismay of neighbors more interested in feeding birds.

Kansas has three species of tree squirrels: eastern gray, northern fox, and southern flying. Gray and fox squirrels are game species, whereas flying squirrels are not.

## What Makes a Squirrel a Squirrel

Gray, fox, and flying squirrels are members of the rodent order (*Rodentia*) and can be easily distinguished from each other. The gray squirrel is the smaller of the three species, weighing between 14 to 24 ounces and measuring 17 to 20 inches long. Fox squirrels are larger, weighing one to two pounds and measuring 18 to 27 inches long.

Gray squirrels vary in color from gray to brownish gray with a white belly. Some color variation does occur, and completely black (melanistic) are more common in fox squirrels than in other Kansas mammals. Fox squirrels are

typically grizzled salt-and-pepper gray with a touch of yellow or orange upper body parts and pale yellow to bright orange underparts. The fox squirrel's tail usually has numerous yellow-tipped hairs, while gray squirrels have white-tipped tail hairs.

Flying squirrels cannot be confused with gray or fox squirrels. Flying squirrels are much smaller than the other squirrels (measuring 9 to 18 inches long and weighing 2 to 6 ounces). They have a flattened bushy tail and a loose fold of skin connecting the forelimbs and hindlimbs. Other distinctive characteristics include thick, silky, soft fur which appears glossy olive-brown above and white underneath. The two colors are separated by a black line along the edge of the skin fold.

## Distribution and Range

All three of these species can be found throughout most of eastern Kansas where appropriate habitat exists. Gray squirrels can be common urban residents in the eastern one-fifth of Kansas. Squirrels have adapted to urban environments and are some of the more common wildlife likely to be found in city parks and backyards.

## Cover, Food, Water, and Space Needs

### Cover

The habitat requirements for these squirrels are similar enough so that the bushytails can be found living side by side in some areas. Squirrels are woodland species requiring an ample supply of soft and hard mast-producing trees for their food supply. Old mature trees (cavity trees) are necessary for nesting and denning. The main difference between good gray squirrel and good fox squirrel habitat is woodlot size (in acreage) and the age of trees that make up the woodland.

The favorite haunts of gray squirrels are the more extensive forests and woodlands with dense understory vegetation. Gray squirrels do not spend much time on the ground and prefer woods thick enough to travel from one treetop to the next. Southern flying squirrels require habitat similar to gray squirrels, and their abundance may be controlled more by the amount of hollow trees and limbs for nesting and available food rather than particular tree species.

The fox squirrel spends a considerable amount of time feeding on the ground and has no qualms about living in open



lands. Fox squirrels can be found in a lone tree in the middle of a huge open area. The fox squirrel, therefore, is more common to farm woodlot and fencerow types of habitat than the gray squirrel.

All three squirrels are cavity nesters, preferring to nest and den in hollow tree cavities. Optimal habitat should have two to three suitable nest cavities per acre. Abandoned woodpecker holes are important for flying squirrels because they are large enough to admit flying squirrels and small enough to keep gray squirrels out. Gray and fox squirrels will build and use leaf nests for reproduction and summer denning. Fox squirrels appear to use leaf nests more for reproductive purposes. Leaf nests are also used for emergency cover and for cool resting sites during the summer. An adult squirrel may have several leaf nests in addition to a cavity den.

**Food and Water**

Gray and fox squirrels are almost entirely vegetarians (Table 1), whereas flying squirrels are more carnivorous, eating insects, invertebrates, birds, bird nestlings, eggs, and carrion. Squirrels eat approximately 1 to 2 pounds of food a week. Their major food sources include acorns and hickory nuts. Squirrels will also eat the seeds and fruit of pines, maples, elm, dogwoods, hackberry, wild cherry, and mulberry. In the winter they also eat buds and the inner bark of maples, elm, and oaks. Mushrooms, an occasional insect, and lichens round out their diet. Because fox squirrels are found in more agricultural areas, corn can be an important component of their

**Table 1. Important food plants for tree squirrels in Kansas**

Pines	Blackberries	Dogwoods
Hickories	Cherries	Hackberry
Oaks	Maples	Mulberry
Hornbeam	Grapes	Pecan
Black walnut	Blackgum	

diet. Squirrels store abundant fall mast crops by burying nuts, seeds, and grain or storing these in tree cavities.

Squirrels are not dependent on free-standing water and can derive their water needs from the moisture content of the foods they eat. They will drink freely from open water sources, such as creeks, ponds, or other water structures. These free-standing water sources are an attractive feature in squirrel habitat.

**Space**

Squirrels are relatively stationary animals, and their normal home range rarely covers more than 10 acres during any one season. Over the course of a year, fox and gray squirrel home ranges do not exceed 40 acres. Flying squirrels are even more stationary and have a normal home range of 4 to 5 acres.

Food gathering and storing dominate daily activity patterns for squirrels. Gray squirrels are most active at first light in the morning and in the late evening as darkness approaches (crepuscular). Gray squirrels are active after dark on bright moonlit nights. Fox squirrels are most active at mid-morning and mid-afternoon, although they may remain active throughout the daylight hours (diurnal). Flying squirrels are strictly nocturnal (active at night) and are active throughout the night during the warmer months. Flying squirrels are also active during the winter and become very social, with many individuals sharing a common nest.

Seasonal movements of squirrels are generally confined to a small area; however, there are astonishing records of gray squirrel “migrations” that occur during the fall. These movements are not true migrations for these reasons:

- *they are not a predictable annual occurrence,*
- *they do not involve the return of the animals, and*
- *they seem to occur for no apparent reason.*

Old reports describe movements by gray squirrels that rival the flights of passenger pigeons, with one report of a wave of squirrels 130 miles wide and 150 miles long. Because these movements occur when populations are at peak levels (fall), the most plausible explanation is overpopulation in any one geographic area.

**Reproduction**

Squirrels have two breeding seasons, winter and summer. The winter breeding season begins in December and peaks in early January (February for flying squirrels). The peak of the summer breeding season occurs during early July. Three to four nearly hairless, blind young are born 40 to 45 days later in the nest. The tiny young squirrels weigh about half an ounce. They open their eyes after 32 days and emerge from the nest when they are about 45 days old (April or October). The youngsters are then weaned and are on their own at 2 months of age.

Gray squirrels are more promiscuous than fox squirrels. Gray squirrel males give pursuit to any available female, whereas fox squirrels pair together for the breeding season. Male and female fox squirrels share the same nest until the young are born. The female then drives the male from the nest.

Female squirrels are fiercely protective and chase any other squirrels away from the nestlings. The female does not bring food to the nest; rather, she continues to nurse the young until they are moving around the nest and eating solid foods at about 6 weeks of age. Some adult females produce young during both breeding seasons, whereas others produce young during only one season. The tendency to produce two litters in a year generally depends on the mast crop the preceding winter and the general condition of squirrels coming into the winter breeding season.

Squirrels are solitary animals that live quite socially with

other squirrels in suitable habitat. Family groups (a female and her young) can be found living together until the young leave. Males and females may share living quarters during the mating season. There is a social order where males are dominant over females, and females are dominant over young. Squirrels are not highly territorial; however, a female is intolerant of other females around her nest site.

### *Population Dynamics*

Squirrel populations periodically rise and fall and are linked to the quantity and quality of available habitat. Like most small game species, squirrels have high reproductive and death rates. Normally, more than 50 percent of the squirrels in a population die each year. Squirrels are a favorite food of many predators, including hawks, owls, snakes, foxes, house cats, and dogs. Squirrels are also susceptible to a variety of parasites and diseases. Most squirrels in the wild never reach 4 years of age.

The fox squirrel's original range was limited to the edge of the eastern forest and along woodland habitats associated with river and creek drainages that broke up the original prairie landscape. Forest cutting, grazing, and the planting of agricultural crops by settlers created ideal fox squirrel habitat where it had once been in short supply, causing populations to flourish.

In recent times, continued land clearing and intensive agriculture have eliminated much of the prime fox squirrel habitat. The woodlots, timbered creek drainages, and fencerow habitat that fox squirrels require were largely modified or eliminated. Gray squirrel habitat has also suffered during recent times. The extreme eastern Kansas forests have been cut, and these cuttings have eliminated prime gray squirrel habitat by breaking up the forests into smaller tracts and removing trees old enough to have suitable nesting cavities.

Some of this loss of nesting sites can be replaced by installation of squirrel nest boxes.

### *Houses for Fox and Gray Squirrels*

Tree squirrels such as the fox and gray squirrels readily use man-made houses. In areas lacking den trees, these houses can help to increase squirrel populations.

The squirrel house is identical to the wood duck house except for the size and location of the entrance hole and location of ventilation holes. Drill the vent holes on the side opposite the entrance. A smooth inside surface below the entrance hole is permissible.

The entrance hole should face south or east—away from prevailing winter winds—because squirrels will utilize houses not only for raising a family but also for winter shelter. The house can be half filled with dry leaves to make it more attractive to squirrels.

Houses in dense woods will be more apt to attract gray squirrels. Houses in open stands and on woods edges will probably attract fox squirrels. One or two houses per acre in a woodland is usually sufficient to achieve a maximum squirrel population.

### *Mounting*

Place houses at least 20 feet above the ground in trees that are at least 10 inches in diameter. Use a lag screw and washer at both top and bottom of back piece.

### *Tire Shelters*

The Maryland Game and Inland Fish Commission developed a design that uses one-half of a car tire to make a durable, weatherproof squirrel house. Squirrels seem to like them, and they are fairly inexpensive and vandal-proof. However, steel-belted radials do not work well due to the cutting involved.

### *Materials*

House—One 14- to 16-inch automobile tire (one tire will make two houses). Steel-belted radials are not recommended.

Hanger—18 inches of sturdy, bendable metal rod.

Nails—Six 2-inch galvanized roofing nails.

Equipment—Carpet knife, electric jigsaw with knife edge blades, electric drill with bits, pliers, cord with weight, rope, and metal tubing.

### *Construction*

1. Remove both beads and cut the tire in half (Figure 1a). You can use a modified hacksaw blade or linoleum or carpet knife if you're only cutting a few tires. Be careful when cutting tires with a carpet knife to prevent slips due to hand and wrist fatigue. If you have to cut a lot of tires, an electric jigsaw fitted with a knife-edge blade may prove handy. Drill starter holes for the jigsaw blade. The knife-edged blades tend to overheat and break, so plan on replacing blades after cutting five to 10 tires.

2. Make cuts and drill the holes in each tire half as shown in Figure 1b. A carpet knife may give better control for making these small cuts.

3. Bend the lower end up and inside the upper end. Match the appropriate holes and fasten the sides together using the roofing nails. If you have trouble matching the sides, fold the tire and use the outer holes as guides to mark the inner holes.

4. Fasten holes so that the upper side overlaps the lower side to keep rain out (Figure 1c).

5. Drill the hole for the hanger so that the entrance tilts slightly downward to exclude rain, and drill four or five  $\frac{3}{8}$ - to  $\frac{1}{2}$ -inch holes in the bottom of the house for drainage.

6. Bend one end of the hanger rod into a tight loop or crimp. Slide a roofing cap, followed by a 2- × 2-inch rubber square, down to this crimp. This will help prevent the hanger from pulling through the top.

7. Insert the rod through the top of the shelter and bend it to form an open loop to fit over a tree limb (Figure 1c).

### Mounting

Hang the shelter from a tree limb at least 20 feet up. Unless you're very sure of your tree-climbing abilities, use a ladder or sectional pole to hang it.

Figure 1a.

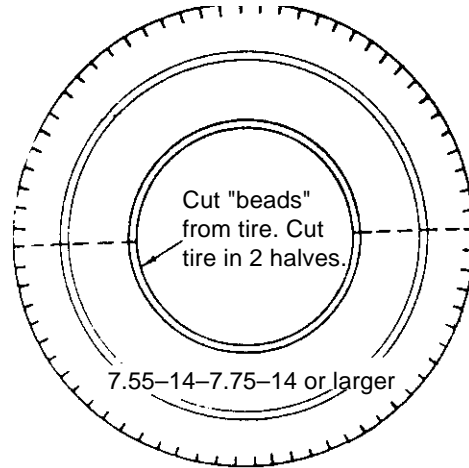

Figure 1b.

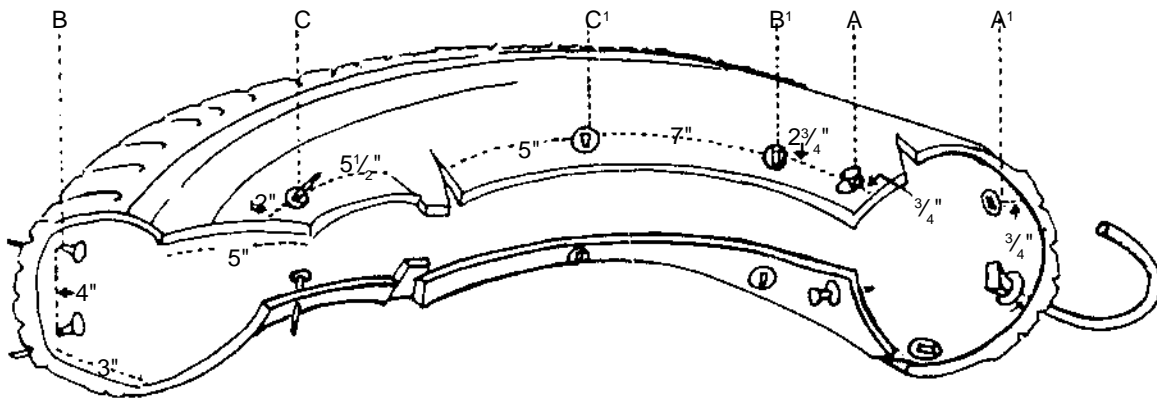
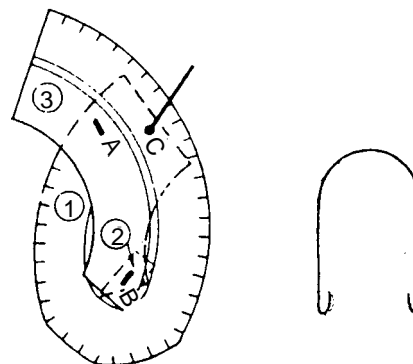

Figure 1c.







## Chapter 35

# Cottontail Rabbit Management

Jeffery D. Sole

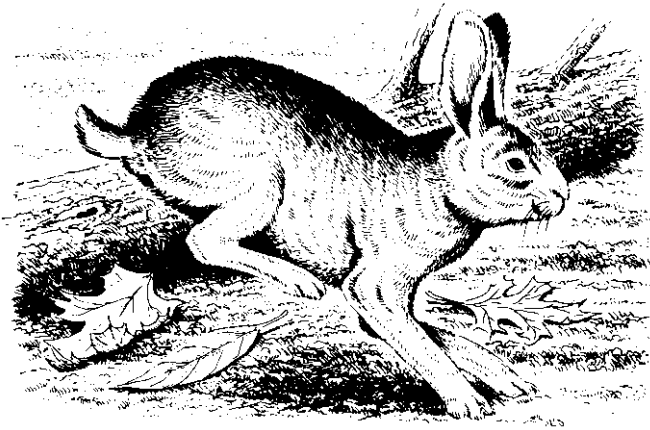

**T**hree species of rabbits are found in Kansas. The eastern cottontail, found throughout the state, is the most numerous. The desert cottontail, can be found in the southwestern region. The swamp rabbit is the largest cottontail in Kansas and is restricted to the extreme southeastern part of Kansas. All rabbits belong to the mammalian order *Lagomorpha*.

## *What Makes a Cottontail Rabbit a Cottontail Rabbit*

Eastern cottontails are grayish-brown on the sides and back with a white underside. The stubby white puffball tail gives the cottontail its name. Their large, oversized ears and large eyes are also characteristic, and they help protect the cottontail from the numerous predators constantly seeking to dine on them. Cottontails also have large hind feet and powerful haunches that aid them in their quick-sprinting escapes to protective cover. Adult cottontails weigh about 3 pounds, and they measure 21 inches long.

## *Distribution and Range*

Eastern cottontail rabbits are agricultural lands animals. Good cottontail populations are found in all areas of the state with suitable habitat. Highest rabbit populations have traditionally been tied to active agricultural lands or reverting farmlands.

## *Cover, Food, Water, and Space Needs*

### **Cover**

Prime eastern cottontail habitat consists of farmland with a mixture of young woodlands, brushy fencerows,

grass/legume hayfields or pastures, and croplands.

Woodchuck burrows, hollow logs, brush, or rock piles are extremely important to cottontails because these structural habitat components provide refuge from inclement weather and predators. Croplands are not essential to rabbits; however, the habitat created by fallowed or abandoned croplands provide excellent cottontail habitat. Cottontails use dense, woody ground cover for escape and occasionally for feeding cover. Reverting farmland, with its briars and brambles, often have excellent cottontail populations.

Food is generally not limiting to cottontails in Kansas, whereas escape or feeding cover (woodlots with substantial understory, brushy fencerows, woodlot edges, tall grass) in the winter is the factor limiting cottontail abundance. Cottontail habitat still exists across most of Kansas, and there is little chance rabbits will be eliminated to any large extent. Changes in farming practices (from small family operations to agri-corporations) have had a serious effect on cottontail rabbits. The result of this change has been the loss of many woodlots, fencerows, and shrubbery so essential to quality rabbit habitat.

Another serious factor affecting cottontail rabbits has been the widespread use of tall fescue and brome grasses for pasture conversions and renovations. Nonnative grasses form a dense, thick mat of vegetation so a rabbit cannot seek shelter under it. In addition, most tall fescue is infected with an endophytic fungus which has been associated with fescue toxicosis (summer syndrome). In cattle, this condition causes depressed feed intake, decreased growth, lower milk production, poor reproductive performance, elevated body temperatures, higher respiratory activity, and low blood serum prolactin. Diets of endophyte-infected fescue have been shown to reduce reproductive performance in horses, sheep, rats, and mice. A study in Kentucky showed a relationship between cottontail abundance and the amount of fescue in the landscape. Areas dominated by fescue had fewer cottontails.

### **Food and Water**

Cottontails are opportunistic vegetarians and depend on succulent green plants for nutrition and water. More than 100 items have been identified in cottontail diets, and diet variation is influenced by plant moisture content, growth stage of the plants, palatability, and relative abundance of various plant species. A high-quality grass/

legume (not fescue) pasture close to suitable escape and winter cover will provide nutritious food throughout most of the year.

Three distinct feeding seasons have been identified for cottontails. In spring and summer, the rabbits prefer succulent vegetation, including numerous grasses, sedges, and forbs. During this period, grasses may constitute up to half the rabbit's diet. As fall progresses, the diet shifts to the bark and fruits of woody vegetation until late winter when rabbits depend on woody vegetation. During this period, rabbits make extensive use of sumac bark because of its high fat content.

Rabbits are unusual in that they eat their own pelleted excrement. A cottontail produces two types of droppings, dark brown pellets and green pellets. Because the green pellets are only partially digested, they can be re-eaten and the nutrients absorbed by the rabbit. Brown pellets have all the nutrients extracted from them.

Eastern cottontails will freely drink open water; however, they are not dependent on free-standing water. Their water needs are generally met by the moisture content in the foods they eat.

### **Space**

Rabbits are relatively stationary animals, and a cottontail may spend its entire life on an area as small as an acre. Most cottontail home ranges are in the neighborhood of 5 to 10 acres, and the average is around 13 acres. Female home ranges vary from 1 to 8 acres, whereas males have been observed roaming over 2 to 49 acres. Winter ranges are greatly reduced for both sexes with animals living in areas close to dense cover.

Young rabbits may move two to three miles in an effort to find suitable habitat. After they become established in a new home territory, cottontail rabbits lead a fairly solitary life. Although rabbits live in close proximity to one another, they live quite independently of each other. Daily movements generally center around feeding activities at dawn and dusk. At this time, numerous rabbits are attracted to the same feeding area although there is little contact among individuals.

### **Reproduction**

Eastern cottontail rabbits are prolific and promiscuous breeders giving rise to a very high biotic potential. A female rabbit (doe) has the potential to produce up to seven litters a year (four to five is the average). Each litter will have an average of five young in the nest.

Breeding season for eastern cottontails usually begins in January. Three to eight young are born 30 days later in a fur-lined nest cavity. Cottontail nests are cup-shaped cavities dug into the ground near the edge of a grassland

area. The nests generally have an overhanging "roof" of grass to cover the cavity. The female cares for the blind, nearly hairless young for 15 days. The young begin exploring the area surrounding the nest at this time. The nest is abandoned shortly after the nursing period, and the young rabbits begin feeding on vegetation.

Young rabbits reach maturity at approximately 8 months of age. A doe rabbit can become pregnant the day she gives birth or while she is nursing her litter. Breeding activity can continue into November, and the size of late litters depends on the condition of the female.

### **Population Dynamics**

#### **Eastern Cottontail**

The yearly population cycle for cottontail rabbits is one of extraordinary fluctuation. Less than 20 percent of the rabbits live until 1 year of age. Only one out of every four or five young produced in a breeding season will survive until the fall hunting season. If a rabbit makes it through one year, the mortality rate decreases considerably. A 3-year-old rabbit in the wild is rare. Population densities on exceptional rabbit range may be as high as five rabbits per acre. On small tracts with excellent habitat, one rabbit per acre is a reasonable density. On areas exceeding 1,500 acres, one rabbit per 3 acres is considered an excellent density.

Probably the most well-known disease affecting rabbits is tularemia (rabbit fever). This disease is caused by a virus transmitted to rabbits by ticks and mosquitoes. Tularemia is deadly to rabbits and can decimate a population in a matter of days. As with most diseases and parasitic infections, the higher the population, the easier the infection spreads. Other natural population controls include various liver flukes, lungworms, tapeworms, roundworms, and pinworms.

Rabbits are also one of the most highly sought-after prey of many furred and feathered predators. Cottontails are a regular constituent in the diets of great horned and barred owls, red-tailed and red-shouldered hawks, red and gray foxes, coyotes, weasels, skunks, and numerous other animals. Remember that the rabbit's high biotic potential is an adaptation to these typically large losses.

Rabbits can withstand heavy predation if suitable habitat is present in the area. Heavy predation in any local area is a sign of inadequate habitat for the rabbits. As long as the habitat is suitable, predation cannot significantly decrease populations beyond their normal fluctuations due to other environmental factors.

## Questions for Chapter 35

1. Describe good habitat for the eastern cottontail.
2. Describe the food, cover, water, and space requirements of the cottontail.
3. Why are cottontail rabbits considered an annual crop?
4. What appears to be the major factor limiting cottontail rabbit populations from increasing in Kansas?

Name \_\_\_\_\_





## Chapter 36

# Furbearer Management

Lloyd Fox

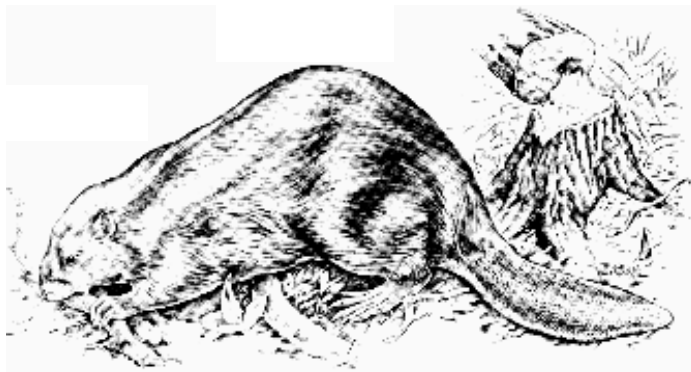

**F**urbearers are a diverse group of 18 species in Kansas that have been or are currently valued for their pelts, which are used for making clothing or felt or have been classified as fur-bearing animal to provide increased protection to their populations in Kansas or elsewhere. Most people prize the opportunity to observe a mink, bobcat, fox, beaver, or any other furbearer in the wild, and trappers, hunters, and photographers spend many hours pursuing these elusive creatures. Furbearers also provide a direct and indirect source of income to many Kansans who sell the hides. Many furbearers are also some of nature's best pest control agents because they eat large numbers of mice, rats, and other small mammals.

Because furbearers represent seven different mammal families, and occupy a variety of habitats ranging from wetlands to mature forest, it is difficult to adequately present all the habitat requirements and life-history strategies for each species in a short chapter. Furbearer management is further complicated by:

- *the varying amounts of land that different species need,*
- *their relationship with other furbearers and wildlife, and*
- *man's relationship to them.*

Some furbearers like the beaver, river otter, and muskrat are considered aquatic furbearers because they require surface water in sufficient size to meet their food, cover, and space needs. Other furbearers like the raccoon and mink are classified as semi-aquatic furbearers because they are usually "water-associated." However, they can and do spend much of their lives on upland or terrestrial areas with little surface water. Terrestrial or upland furbearers like the red or gray fox, coyote, North American badger, opossum, striped or spotted skunk, bobcat, and long-tailed or least weasel require some

drinking water but are not associated with water as a general habitat requirement.

This chapter on life-history descriptions of each species is intended to provide you with a better understanding of their habits and requirements. It will explain some of the similarities and complexities of managing this diverse resource.

## Beaver

The beaver is one of the most important North American mammals from historical, economic, and aesthetic perspectives. Just like wild turkeys, white-tailed deer, and wood ducks, the restoration of beaver in this country can be considered one of America's great modern wildlife management success stories.

The pursuit of beavers, primarily for their fur which was used to make hats in Europe, led to the exploration and colonization of the majority of North America. The period from 1550 to 1840 has been called the *era of beaver trade* in North America. The fur trade, based largely on the sale of beaver pelts, greatly influenced the economic and political development of this country. Before the arrival of European settlers in North America, beavers could be found in almost every stream, creek, or river throughout the United States and Canada.

Early explorers and fur trappers exploited this resource and sent large numbers of beaver pelts to Europe to make hats and coats. As the supply of beavers in an area dwindled, the trappers moved into unexplored country to meet Europe's growing demand for finished goods made from beaver pelts.

This pattern of pioneer exploration and beaver exploitation followed until most of North America had been explored. During the 1700s and 1800s, the beaver was this continent's most important natural resource. However, by the early 1900s the beaver was almost extinct throughout much of its range because of this uncontrolled harvest.

It was not until state conservation and wildlife agencies were established in the 1920s that the historic comeback of the beaver began. During this period, the beaver received complete protection from trapping and hunting in many areas. This protection and subsequent natural population growth provided the important beginning of beaver restoration. From the 1920s through the 1950s, beavers were live-trapped and released into suitable habitat. This restocking program and protection were important factors in returning the beaver to its historic range and population levels. Other contributing factors

were a reduced predator population (wolves, mountain lions, and bears) and an increase in food sources that recovered during the beaver's absence. Many authorities believe the beaver is more abundant today than at any other time in history.

As throughout the rest of the country, the beaver population was reduced through most of Kansas with the exception of a few isolated populations. During the late 1940s and early 1950s several beaver releases were made in the eastern portion of Kansas. From these releases and the natural movement of the animal from within the state and other bordering states, the beaver can now be found in every Kansas county where there is permanent surface water.

Beavers are generally considered beneficial in situations where they do not compete with people for the use of the land, water, or timber. Harvesting beaver pelts may be a source of income. While fur prices vary from year to year based on fashion trends, recent information collected by the KDWP nearly showed that more than 15,000 beaver pelts, valued in excess of \$200,000, were sold during the 1986-87 trapping season. Beaver ponds also attract a wide variety of other furbearing animals, including mink, muskrats, and raccoons. The value of these pelts, based on the same survey, was more than \$2.2 million.

The unique dam- and pond-building attributes of beavers create favorable habitat for a variety of wildlife species, including fish, ducks, shorebirds, amphibians, and reptiles. The variety of wildlife attracted to these ponds can be used for recreational, scientific, or aesthetic purposes.

Other benefits of beavers include ponds created by their dams that help stabilize water tables, reduce rapid runoff from heavy rainfall, and reduce soil erosion by depositing silt in the pools. Beaver castoreum is used in perfumes and cosmetics and in numerous trapper's lures. Finally, beaver meat is excellent table fare if properly prepared.

### ***What Makes a Beaver a Beaver***

Beavers are the largest rodents in North America. They belong to the family *Castoridae*. Adult beavers weigh between 30 and 64 pounds and measure 25 to 31 inches in length. They are large-boned and heavily-muscled animals with short hindlegs and with large webbed feet adapted for swimming. Their hindlegs are webbed, whereas their forefeet are heavily clawed. They use their nimble forefeet to turn and hold small twigs while they peel the bark with their teeth.

The beaver is most recognized by its large, flat, hairless tail, which it uses when swimming and as support when standing on land.

Beaver fur is comprised of soft, downy underfur and long, coarse guard hairs. The fur is brown, but individual coloration may range from a creamy blond to nearly black. Beavers comb and groom their fur with the aid of a doubled or split toenail on their hindfeet.

The sexes are indistinguishable, except for nursing females with swollen mammary glands.

Like many other rodents, beavers have large, orange front teeth (incisors) that grow continuously throughout their life. Located directly behind these incisors is a set of lips that seal when the beaver dives under water. The animal also has valves inside the ear and nose that close when it is under water. These closed valves and lips allow the beaver to cut and gnaw on woody or herbaceous plant material under the water.

### ***Cover, Food, Water, and Space Needs***

The beaver is one of a few mammals, other than man, capable of modifying the habitat to suit its needs. When beavers move into an area, they quickly begin building dams to modify the habitat more to their liking. Once the dam has been built from surrounding trees, the subsequent flooding causes the trees to die and other aquatic plants to begin growing. Often, the new plant growth around the edge of a pond (willows, cottonwood, silver maple, and green ash) are preferred beaver foods.

Beavers are found in a wide variety of wetland habitats, ranging from small streams to large lakes or reservoirs that have stable water levels. Any water source near a suitable food supply is a potential beaver site. Thus, good beaver habitat can be almost any place with a year-round source of water. Appropriate habitat can include streams, rivers, ponds, lakes, swamps, wetlands, and drainage ditches. Beavers living in habitat with good winter food resources appear to have larger litters. The winter food resource also influences the age when the young move from the den or lodge and thus affects the age when young beavers breed.

Beavers feed on the cambium layer (just under the bark) of woody plants and a variety of aquatic and upland vegetation. Preferred woody foods include willows and cottonwood, although they can and will feed on the leaves, twigs, and bark of more than 40 woody species. During the summer, they also eat water lilies, pond weeds, and cattails. Sometimes beavers travel substantial distances from the pond or stream to corn or soybean fields where they cut the entire plant off at ground level and drag it back to the water. What they do not eat, they use for constructing dams and lodges.

Beavers are highly territorial and stationary animals. They actively defend their colony's territory against outsiders by using scent marking. Annual home ranges usually vary from one-half to one and a half miles of stream length. However, home range size varies greatly by the water system where the beaver lives.

"Busy as a beaver" appropriately describes beaver behavior. Beavers are active for about 12 hours each night, feeding and working on the dam. Most daily movements are centered around the pond and lodge. The female parent in the colony is relatively stationary during the spring and summer as she cares for the young. When young beavers move to another

location to establish their own territory, they may travel five to six miles. Other travels by individual beavers include wanderings by yearlings and adults who have lost their mates.

### **Reproduction**

Beavers are social animals and live in family units called colonies that range in size from two to eight, with an average size of five to six. A colony consists of the adult pair, the current year's offspring (kits), the previous year's offspring, and occasionally a 2-year-old offspring. When beavers become sexually mature, usually at about 18 months, they leave their home colony to form a colony of their own.

Beavers are monogamous and mate in January and February. Two to four 1-pound kits (similar in appearance to the adults) are born in March and April. The kits grow rapidly, nursing for about 60 days. By 6 months of age they weigh between 8 and 10 pounds. The female does all of the kit-rearing.

Beavers have a relatively long life-span for a wild animal. Most beavers do not live beyond 10 years of age although some may live 20 years or more. Historically, wolves, lions, bears and aboriginal man preyed on beaver. Predation by river otter has been documented, but it is rare. Predators today include coyotes, bobcats, and free-ranging dogs. Man is still an important predator. However, neither wild nor human predators are considered a limiting factor in most cases.

Beavers also die from starvation during the winter. In the northern portion of their range, sudden rises in water level during iced-over periods can result in mass drownings. Tularemia is a disease that can cause widespread population declines.

## **River Otter**

No other North American furbearer inspires such a wide variety of images as does the North American river otter. The river otter is one of the most playful members of the weasel family (*Mustelidae*). The media has used this playfulness to make the river otter one of America's most popular wildlife species. However, a variety of television programs depicted domestic otters, giving rise to several misconceptions about the life of otters in the wild. The following description provides you with a realistic view of the life of a wild otter.

### **What Makes a River Otter a River Otter**

The North American river otter is a long, cylindrical, semi-aquatic mammal. It has small ears and eyes and a flattened head with a prominent nose pad. The animal's size surprises most people. Otters weigh between 11 and 30 pounds and measure 36 to 50 inches long. The long, heavy tail, tapering from the body to its tip, comprises about one-third of the animal's length. Otters have short legs with fully webbed toes. Male otters are generally larger than females.



River otters have a thick, durable, and luxurious pelt, which was once the standard to which all other North American furs were compared. Pelt coloration on the back and sides ranges from light to dark chocolate-brown. The belly is usually lighter in color with the neck region appearing to have a silvery sheen when observed in bright sunlight.

Historically, otters could be found in every major river system throughout the United States and Canada. The river otter was only absent from the arid southwest and extreme northern Canada and Alaska. Currently, otters are found in 45 states and all of the Canadian provinces. This sounds as if they are still widespread; however, some midwestern states have only small, isolated populations that are present due only to restoration efforts. During the early to mid-1980s the following states began river otter reintroduction or restoration programs: Arizona, Colorado, Iowa, Kansas, Minnesota, Missouri, Nebraska, Oklahoma, Pennsylvania, Tennessee, and West Virginia. The greatest river otter densities probably occur in Louisiana's swamps and marshes, while lowest densities occur in Rocky Mountain streams.

In Kansas, the river otter was thought to be extinct by 1904. The KDWP, with the financial aid of the Kansas Fur Harvesters Association, conducted an experimental river otter restoration effort on the South Fork of the Cottonwood River in 1983-84. Nineteen otters were released. Eleven of 13 radio-marked otters were known to survive. Numerous young have been produced by this restoration project. After the restoration project, reports of otter sightings, accidental trappings, and roadkills indicated that natural populations have developed.

Historical records are incomplete, but the information available suggests river otters were abundant before the arrival of European settlers on this continent. At the peak of land settlement in this country, around the late 1800s and early 1900s, river otters were at their lowest population levels. The otter was totally eliminated from a large portion of its historical range as a result of:

- 1) *unregulated hunting and trapping,*
- 2) *changing land-use patterns,*
- 3) *water pollution, and*
- 4) *more recently, acid rain.*

Thus, man, through environmental degradation and overexploitation, has been the primary threat to otters.

### ***Cover, Food, Water, and Space Needs***

Otters prefer a wide variety of aquatic and wetland habitats. In general, otter habitat consists of any area that has a stable water level, an ample food supply (primarily fish), and no water pollution. Home to an otter is a beaver lodge, overhanging bank and previously excavated burrow, or root wads. Information collected from the restoration project indicated that most river otter den sites were of beaver origin, either bank dens or lodges. The otters would frequent these sites even when beavers were present in the dens.

Chemical, industrial, and agricultural pollution has altered many of our pristine streams. In Kansas, the major factor limiting otter abundance is water quality. Habitat destruction (wetland drainage), decreased water quality, and the increase of pesticides in the water have all resulted in population declines. Although no harvest is planned for the otter in Kansas, carefully managed seasons in other states have been conducted, and stable otter population have been maintained.

The feeding habits of river otters have been extensively studied. Otters are primarily fish eaters although crayfish are also a favored food. Snakes, frogs, salamanders, snails, insects, clams, earthworms, and a variety of mammals and birds have been recorded in otter diets. Otters' feeding preference is usually based on what is available at the specific location. In the southern portion of their range, where fish productivity is high, otters eat fish but eat crayfish when it is available. The relative abundance of various fish species and their maneuverability determine which fish species are eaten. This means that otters prey more on slow-moving fish than on faster-moving species.

River otters are solitary animals although a family group of a female and her young are occasionally seen. Sometimes, when food is abundant, otters gather in large concentrations. For the most part, otters are active at night but occasionally may be active during the day. The seasonal movements of otters vary between sexes and individuals.

The most important factor in determining home range size is the presence of an activity center. Activity centers have adequate water, cover, and food. Otter home range size is determined by the distance between activity centers. Daily travels may range from 1 to 1.5 miles of stream. Over the course of a year, otters may range up to 10 miles, and during their lifetime they may travel up to 100 miles. Males generally have larger home ranges due to increased activity during the breeding season.

River otters do not seem to be territorial in the usual sense. Several otters can use the same home range area and activity center, but they avoid each other within that area by scent marking. When otters defecate, they deposit a musky smelling secretion from a gland located at the base of their tail.

They also make a mark at the junction of stream tributaries, crossings at beaver dams, and other areas where otters travel.

### ***Reproduction***

Otters become sexually mature at 2 years of age. Breeding season begins in late winter and early spring. Otters are promiscuous, and a male will travel great distances to breed with as many females as he can. Like other members of the weasel family, river otters exhibit delayed implantation. After insemination, the fertilized egg will develop slightly. It then enters a period of suspended animation when no further development occurs until it implants in the uterine wall 7 to 10 months after fertilization. The egg then continues to develop, and the active stage of pregnancy lasts only about 60 days.

One to six blind and helpless young (the average litter size is two to three) are born January through May. The young open their eyes between 21 to 35 days after birth, and at 2 months of age they are introduced to the water. Young otters begin eating solid food by 2 weeks of age and are totally weaned at 3 months. The mother is their sole caretaker. The family group of mother and young will begin to break up about 3 months after weaning. The cycle begins again when mating occurs immediately after the birth of the young.

Today, the recovery of river otter populations in Kansas offers us an opportunity to wisely manage this species for the enjoyment of future Kansans. The success of river otter in Kansas is dependant upon our willingness to maintain clean, abundant water in our streams and rivers. The success of river otter is also dependent upon the tolerance of Kansas landowners for this species and support of trappers and other people who enjoy wildlife.

## **Muskrat**

Muskrats are generally considered the most valuable furbearer in the North American fur trade. This is due to their broad distribution and high densities in localized areas. They also hold a special place in the wildlife community because much of the scientific theory relating to compensatory mortality was derived from studies with muskrats. Paul Errington, who conducted extensive studies of muskrats from the 1930s through the 1960s, authored four books based on his studies of muskrats, marshes, and predation. Errington found that when large numbers of muskrats are removed from a population (by trapping, predators, disease, etc.), the remaining muskrat population responded by increasing its litter size and the number of litters produced each year.

### ***What Makes a Muskrat a Muskrat***

Muskrats are the largest *microtine* (meadow mice-vole family of rodents) rodent in the United States. Muskrats are stocky animals with a broad head and short legs. They have a flattened tail, which is scaly and sparsely haired. Their pelts

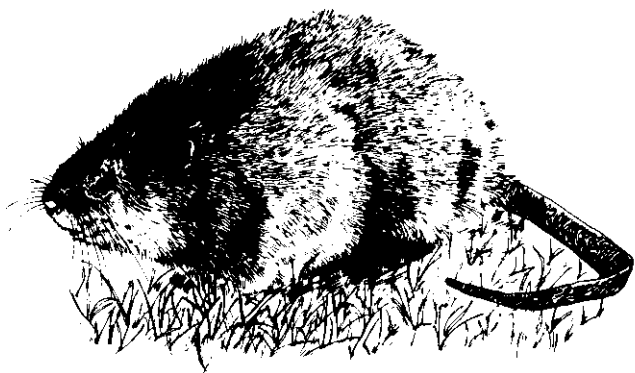

consist of soft, thick underfur with long, glossy dark-red to dusky-brown guard hairs. Their unwebbed front feet have four sharp-clawed toes and a small thumb. Their large hind feet are webbed or partially webbed with stiff hairs along the toes. Muskrats measure 16 to 25 inches in length, with the tail measuring 7 to 11 inches. Adult muskrats weigh between 1 and 4 pounds.

Muskrats get their name from the pair of musk glands located at the base of their tails. These glands are used during the breeding season when musk is secreted to mark logs or other areas around houses, bank dens, or trails on the bank. Muskrats can be found from near the Arctic Circle in Canada to the Gulf of Mexico. They are found in every state except Florida. They can be found throughout Kansas wherever there is appropriate habitat.

### ***Cover, Food, Water, and Space Needs***

Muskrats live in a large variety of habitats. The habitat for muskrats is almost anywhere they can find a year-round supply of food and water. They are found in ditches, streams, marshes, lakes, beaver ponds, mine pits, farm ponds, or any wetland area. For shelter, they use bank burrows, houses built of vegetation, and feeding huts. Bank burrows are usually 6 inches by 8 inches in diameter and are up to 60 inches long. Muskrats use bank dens mostly during the summer.

Muskrat houses are cone-shaped and measure up to 2 yards in diameter. They are usually constructed of cattail or bulrush stems. Their height varies, and each house will have one or two separate raised internal chambers. Muskrats usually begin house construction in October, which peaks in November. Feeding huts are platforms of marsh vegetation where the muskrat brings food to eat. These circular huts are usually smaller than houses.

The key component of muskrat habitat is slow-moving or non-flowing water that allows the growth of aquatic vegetation. Ideally, the water should be 2 to 3 feet deep. Cattails, bulrush, sedges, and arrowhead (excellent for food and house construction) should be present around the bank.

Muskrats are vegetarians and relish cattails, bulrush, smartweed, duck potato, horsetail, water lily, sedges, young

willow sprouts, and pickerel weed. Muskrats will eat almost any aquatic vegetation, including the bulbs, roots, tubers, stems, and leaves of numerous wetland plants. They occasionally eat corn, soybeans, grain sorghum, and small grains. At times, particularly during periods of low food supply, muskrats will eat animals, including crayfish, mussels, turtles, frogs, or fish.

Muskrats are not great travelers, and the average home range varies from a 66- to a 200-foot circle in optimal habitat. During the spring or fall, and at times of crisis (flooding, drought, food shortages), muskrats can move considerable distances. Muskrats disperse in the spring, beginning in February and March and lasting about a month, when males begin moving. The distance moved varies, and it appears that all ages of muskrats, not just the young, disperse every spring.

### ***Reproduction***

Muskrats are prolific breeders. They can produce an entire generation in about 30 days. Litter size and the number of litters per year are related to latitude. Muskrats produce fewer and smaller litters the farther north they live. In Kansas, muskrats have three to four young per litter and may have three or more litters per year. Muskrats may breed year-round, but the breeding season usually runs from March through October, with a peak in March through June. Males are promiscuous and will mate with as many females as possible. The decline in the number of litters throughout the breeding season is due to the decline in sexual activity of the males. Mating usually occurs while the muskrats are under water.

Twenty-eight to 29 days after mating, 3 to 11 kits are born. The young weigh about three-quarters of an ounce and are 4 inches long. After one week, they are covered with a coarse gray-brown fur. Their eyes open at 14 to 16 days, and at this time they begin to swim, climb, and dive. The female cares for the young (kits). The kits are weaned by about the 24th day and fend for themselves by the end of their first month. The mother should be ready to give birth again by this time. The first litter may stay in the nest; then the mother will add another nest chamber to accommodate the new litter. Males become sexually mature by 6 to 7 months of age, and females born in early spring may be bred in the fall of the same year. The litter size of females bred in their first year will usually be small.

Muskrat populations appear to follow a cycle. This cycle reflects how muskrats influence their food supply. In general, the cycle follows this pattern:

- 1) *muskrat numbers are low,*
- 2) *a large food supply develops,*
- 3) *overpopulation occurs due to good breeding condition of muskrats,*
- 4) *habitat is damaged with "eatouts" occurring,*
- 5) *starvation occurs as a large number of muskrats compete for a limited food supply,*

### 6) muskrat numbers are low.

These cycles vary from five to six years in some areas to 10 years in other areas.

Muskrat densities vary depending on the phase of the population cycle, habitat type and its condition, social pressure by other muskrats, competition, harvest, predation, and geographical area. It appears the amount of shoreline is more important than pond size in determining muskrat population levels. Maximum breeding densities appear to be five pairs per 2 acres.

Muskrats are eaten by a host of predators, including hawks, owls, raccoons, mink, fox, coyote, and even largemouth bass and snapping turtles. Muskrats also prey upon other muskrats. During periods of overcrowding, other muskrats may kill entire muskrat litters. During a drought year, when overcrowding problems are magnified, muskrats are particularly susceptible to being eaten by other muskrats and a variety of species already mentioned. Trapping accounts for a high percentage of muskrats being removed from the population each year. Diseases such as tularemia and hemorrhagic disease can devastate an entire population.



## Mink

Mink are semi-aquatic furbearers of the *Mustelidae* or weasel family. Nine of the 18 species of furbearers in Kansas belong to this family. Mink are one of the most popular weasel-like animals and historically one of North America's most important furbearing animals. Mink fur is still one of the major wild furs produced in North America. In 1982-83, the harvest of wild mink on this continent was valued at more than \$11 million.

### What Makes a Mink a Mink

Mink have an elongated body with the tail comprising one-third to one-half of the total length. Males measure 22 to 28 inches in length and weigh 2 to 3 pounds. Females are about 10 percent smaller. Both sexes have a luxurious, dark chestnut-brown pelt for which they are widely sought. The fur is relatively short. The coat consists of a soft, dense underfur concealed by glossy, lustrous guard hairs. Mink usually have

white spots and patches on their chin, chest, and belly. The tip of the tail is usually black.

Mink are found in every state except Arizona. In Canada, mink are found everywhere south of the treeline with the exception of a few islands.

### Cover, Food, Water, and Space Needs

Mink are mainly associated with wetland or aquatic habitats; however, they may move considerable distances from wetlands in search of food. They are shoreline dwellers, and their basic habitat requirements are a permanent source of pollution-free water and shoreline areas free of grazing or development. The shoreline areas should have adequate vegetation (brushy or grassy areas) to conceal their movements. The availability of den sites (muskrat and beaver lodges or bank burrows, holes, crevices, or log jams) appears to limit mink populations. Mink prefer productive waters with high fish, frog, and aquatic invertebrate populations. The water may be turbid or nutrient-rich; however, the wetland habitat must be pollution-free. Mercury, polychlorinated biphenyls (PCBs), and pesticides, such as DDT, DDE, and dieldrin, are known to accumulate in the mink's body tissue and may cause death or complete reproductive failure. It is suggested that areas with high levels of these pollutants act as population sinks for mink. Heavily mink disperse into these areas only to die or become unable to reproduce.

The mink is strictly a carnivorous animal, and because of its semi-aquatic habits, it is adapted for preying on both aquatic and terrestrial prey. Feeding studies have indicated that mink are opportunistic predators and eat mice and rats, frogs, fish, crayfish, rabbits, insects, muskrats, amphibians, reptiles, and birds or bird eggs. Availability of any particular food item determines its frequency in the diet. This varies by season and geographical location.

Mink are active mainly at night although they may be seen during the day. Mink are generally solitary animals, except during the breeding season or when females have kits. Mink home range size is variable and depends on habitat quality, especially the abundance of the food supply and the number of denning sites. Male mink are great travelers, and their home range may include 1 to 4 miles of shoreline (an average of 1 mile of stream). Females move in a small area during the breeding season, and their home ranges may vary from one-quarter to 2 miles of shoreline (average of 1 mile of stream).

### Reproduction

Mink are polygamous, and males may roam extreme distances in search of receptive females. Males may fight ferociously with other males during the breeding season, which extends from late February through April. The female remains in heat throughout the entire breeding season with a peak in receptiveness every 7 to 10 days. This allows the

female to be mated several times during the breeding season. Mating triggers ovulation, which usually occurs 33 to 72 hours after mating. It is possible for females to have eggs fertilized by two or more males if the remating occurs so that there are six or more days between ovulations.

Like other members of the weasel family, mink exhibit delayed implantation. The embryos do not implant in the uterine wall nor do they complete their development until about 28 to 30 days before birth. The total gestation period for mink averages 51 days but varies from 40 to 75 days. In late April and May, one to eight blind, naked, helpless young are born (the average litter size is four). Young mink weigh about one-third of an ounce at birth and exhibit tremendous growth. By 7 weeks of age, they will have obtained 40 percent of their adult weight and 60 percent of their adult length. Their teeth appear at 2- to 3-weeks-of-age, and their eyes open during the third week. The mother raises the young by herself until late summer or early fall when the young leave.

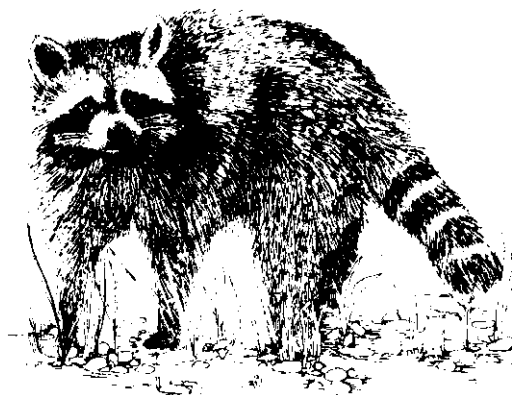

## Raccoon

Raccoons are one of the most adaptable, widespread, and successful furbearer species in North America. They are also one of the most economically and recreationally important furbearers in this state. The harvest of wild North American raccoons for their pelts in 1982-83 was estimated to be worth more than \$90 million. This crafty animal also provides many hours of enjoyment for raccoon hunters.

### *What Makes a Raccoon a Raccoon*

The raccoon is a common and easily recognized furbearer. The combination of a black-mask and ringed-tail makes this species unmistakable. Raccoons have stocky bodies measuring 2 to 3 feet with a broad head and pointed snout. Coloration is generally black above with black-and-white-tipped guard hairs and a pale underfur. Pelts may be variable shades of browns and yellows, with an occasional cinnamon or albino reported. Nearly as rare as the albino is the solid black raccoon, sometimes referred to as a fisher raccoon.

Raccoons have five long, slender toes on each foot that make readily identifiable tracks. Male raccoons are larger than females and weigh between 15 and 18 pounds. Females weigh between 12 and 16 pounds. The heaviest raccoon ever recorded was a 61-pound male taken in Wisconsin.

The raccoon can be found in every part of the United States except parts of the Rocky Mountains. Raccoons can also be found in Mexico and southern Canada. Over the past 40 years this adaptable animal has been expanding its range northwards into Canada. It is estimated that the North American raccoon population is 15 to 20 times larger today than it was before a population explosion in the 1930s and 1940s helped the raccoon expand its range. Although the raccoon is native to North America, it has been introduced into the Soviet Union and Germany.

The raccoon can be found in every Kansas county. Population densities are highest in the eastern counties and lowest in the western counties. Raccoons are most abundant in counties with large amounts of water resources, riparian forests, and grain fields.

### *Cover, Food, Water, and Space Needs*

This adaptable animal can occupy a wide variety of habitats although it prefers mature hardwood forest areas with numerous den trees close to water. Since raccoons are water-associated animals, water is a very important habitat requirement. Raccoons depend on wetland and aquatic habitats for a large portion of their food. They are seldom found far from water.

Raccoons select a variety of different types of dens to give birth and raise their young. The most common den is in a tree. Tree dens may be found in any hollow limb or tree trunk that is large enough for a female raccoon and her litter. Ground dens are important for raccoons, especially in areas that are lacking tree dens. Abandoned fox or woodchuck burrows are most often used as ground dens. Other types of dens include rock crevices, caves, drains, abandoned buildings, barns, and brushpiles. Dens of all types are located near water.

Management practices such as leaving den trees could increase populations in some areas. Also the protection of raccoon habitat, especially wetland habitat, is needed to ensure stable populations.

Raccoons also need brush thickets, ground dens, hollow logs, or trees for cover to escape predators and for daytime resting sites. During the day, raccoons may rest on bare tree limbs or squirrel nests.

Feeding areas vary according to the time of year and the types of food available. Raccoons use aquatic habitat, such as streams, rivers, and ponds, when feeding on crayfish, fish, and amphibians. They use overgrown fields, corn, and other grain fields mainly in the fall and summer when berries, grains, and insects are the mainstay of their diets. Hardwood forests



provide important hard and soft mast, such as persimmons, acorns, and wild grapes.

Raccoons are opportunistic animals and have been known to feed on a variety of food items, which vary seasonally and with different locations. Some known foods include carrion (dead animals), garbage, birds, mammals, insects, crayfish, mussels, a wide variety of grains, and many different types of fruits. Only in the spring do raccoons eat more animal than plant food. During the spring, their diet consists of crayfish, insects, and small vertebrates. Fruits and berries along with corn are most prominent in their diet during late summer. In autumn, fruits, corn, milo, and crayfish are important food sources. Acorns are an important food during the winter in areas dominated by woodlands.

Raccoons are mostly active from sunset to sunrise and den up during daylight hours. Peak feeding is generally over before midnight. Raccoons are least active during the winter months. During periods of low temperatures and snow cover, raccoons will typically sleep for several days in their dens. When temperatures climb above freezing for several days during late winter, raccoons may leave their dens to feed.

During the breeding season, adult males may be territorial. Females are not territorial, and their home ranges may overlap. Several female home ranges may be located within one male home range. Raccoons may have home ranges up to 2 miles long although most are about 1 mile. Home ranges vary depending on habitat conditions and population densities. Raccoons will move long distances when food is scarce or populations are low. Raccoon densities vary from one raccoon per acre to one raccoon per 100 acres.

### Reproduction

Breeding season for raccoons in Kansas ranges from January through April, with peak activity occurring in February. Although males may mate with several females each spring, there is some evidence of pair bonding between males and females. Female raccoons may form a bond with a familiar male about one month before mating. The female will also mate with other males at the peak of estrus. Any type of bond terminates after breeding season, leaving the female to care for the young.

Sixty-three to 65 days after mating, two to eight deaf, blind, and helpless kittens (an average of three per litter) are born between March and June. The young weigh less than half a pound. Their eyes and ear canals open when they are 18 to 24 days old, and permanent teeth are in place by their third month. Infant raccoons feed on the mother's milk until they leave the den at around 10 weeks of age. The mother may move the kittens to ground dens when they can walk. The mother and kittens travel together until the young leave in the fall or winter. In northern areas, young raccoons may delay dispersal until spring.

Female raccoons may become sexually mature and breed at less than 1 year of age. Breeding by kittens depends on food availability as this affects body condition.

Raccoons die from a variety of causes. Canine distemper and rabies are the only two diseases likely to affect their numbers significantly. Starvation can be a major mortality factor for young raccoons during the winter months. Human-induced mortality is thought to be the primary cause of death in raccoons.



### Opossum

Everyone has heard the phrase "playing possum." This phrase originates from the Virginia opossum's habit of paralyzing itself when it is gripped or shaken. The Virginia opossum is the only marsupial and member of the *Dedelphidae* family in North America. Being a marsupial, the opossum carries her young in a pouch or on her back and is in essence a "moveable nest." This has advantages because the opossum is not restricted to any one area and can move as available food supplies shift.

### What Makes an Opossum an Opossum

Opossums are about the size of a large house cat, measuring 25 to 33 inches in length and weighing between 6 to 13 pounds. Females are usually smaller than males. The opossum has a whitish to pale gray cone-shaped head with a white cheek bordered above with a gray or black eye stripe and ring. The back and sides are silver-gray with long, white guard hairs and black-tipped underfur. The ears are naked and black or white with pinkish tips. The lower legs and feet are black, and the toes are white. The first toe on the hind foot is large and opposable, lacking a claw and a nail. The long tail is almost naked and scaly. Sex determination is easy because females have an external, fur-lined belly pouch called a **marsupium**. The teats are enclosed within this pouch.

The opossum is found in two discrete areas of North America. The eastern population is found from southern Ontario, Canada, south to Costa Rica, and east of a line extending from western Nebraska south to Texas. The western population is found along the Pacific coast from British

Columbia south to Baja California. The opossum has been expanding its range in recent years. Using timbered river corridors, the opossum is now established throughout Colorado east of the Continental Divide. Opossums may be found in every county in Kansas.

### ***Cover, Food, Water, and Space Needs***

Opossums are found in every habitat type that exists within its range. However, they prefer woodlands and streams associated with woodlands. Opossums do well in a variety of habitats although the presence of open water is an important factor determining abundance and distribution. The opossum appears to be limited by the accessibility of water and the availability of denning sites. Food is not limiting except where the winter climate is sufficiently severe to hamper feeding.

Opossums are active at night, except during the winter when they may be observed during warm spells in the middle of the day. During the day, they use a variety of den sites, including holes, stumps, crevices, hollow logs, or any other opening they can get into. During the winter, they use ground burrows for dens. It is common to find abandoned squirrel nests enlarged by opossums and made into a suitable home.

What do opossums eat? Just about anything. The opossum is omnivorous and eats a wide variety of food items. Availability of an item determines its frequency in the opossum's diet. Opossums appear to prefer insects, animal flesh, and fruits in that order. The list of insects eaten is impressive and long. Grasshoppers, beetles, crickets, squash bugs, and stink bugs are preferred. Opossums are great scavengers, and much of the bird and mammal flesh they eat is probably carrion (dead animals), especially when remains of cow, dog, domestic cat, raccoon, and skunk are found in fecal material. Fruits are important during the summer and fall. Some of the more common fruits they eat are mulberries, pokeberries, persimmons, wild grapes, apples, ground cherries, and field corn.

Opossums are unique mammals in that they do not establish or defend a home range. They are nomadic wanderers, sleeping during the day and wandering at night. They have been known to wander more than two miles in a single night. Studies have shown they will use areas ranging in size from 10 to 40 acres. Opossum densities vary from one per four acres to one per 105 acres. Males, especially young males, appear to wander more than females.

### ***Reproduction***

The opossum breeding season runs from January through November in Kansas. There are two distinct breeding periods. The first is a six to seven week period of high breeding activity followed by a less intense period beginning two weeks after the end of the first period. Female cycles vary from 12 to 38 days although the female is in heat only 36 hours. Fertile matings occur during the first 12 hours. Females come into

heat numerous times during the breeding cycle but breed only once each cycle.

After a 12-day gestation period, the young opossums are born. The young move to the marsupium by grasping the female's belly hair. Once in the marsupium, the young either attach to a teat or die. The average number of teats for opossums is 13, but only seven to 10 of these are functional. The number of functional teats determines litter size.

The maximum number of litters per female is two per year. Newborn young are one-half inch long and weigh less than one ounce. Young opossums grow rapidly, and by the time they are weaned, at about 96 days of age, they measure 8 inches long and weigh about 6 ounces. Males are sexually mature at 8 months of age, whereas females are sexually mature at 6 months of age.

The average life expectancy of an opossum in the wild is about one year. A total turnover in a population of opossums is produced every five years. Opossums are eaten by a variety of predators, including dogs, coyotes, foxes, raccoons, hawks, owls, and large snakes. Dogs and great horned owls are the major predators. Roadkills are also a major cause of death.

There is little need for managing opossums, other than regulating the harvest, because opossums are abundant, have a high reproductive rate, and are very adaptable, living almost any place that is dry and protected from the weather or predators. Opossums are generally considered beneficial because they eat large amounts of insects, many of which are pests. Occasionally an individual will raid a hen house.

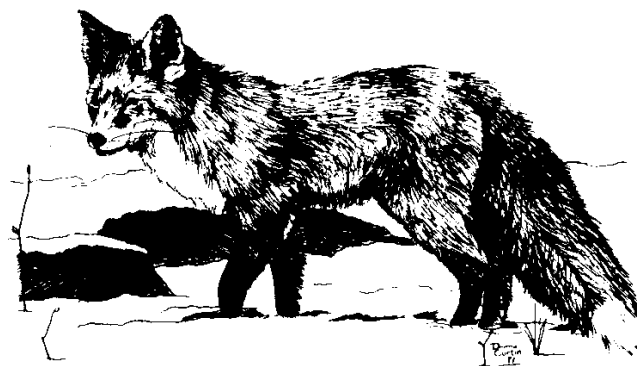

### **Foxes**

Like many members of the dog family (*Canidae*), foxes are either beneficial or harmful depending on your perspective. Many people believe foxes are harmful to game bird populations although this claim is largely unsubstantiated. Others who think that foxes are major carriers of rabies believe foxes are a threat to humans and domestic livestock. Still others believe foxes are cunning, ruthless predators destroying valuable poultry. To this end, millions of dollars have been spent in this country on fox bounties in an effort to reduce their populations.

On the other hand, foxes are beneficial because they capture numerous mice, rodents, and other agricultural pest animals. They are also highly prized for their luxurious fur. Red fox furs sold in North America during 1978-79 were valued at more than \$25 million. This number dropped to \$8.5 million in 1983-84 as the number of pelts and the price per pelt dropped. The value of the gray fox harvest in 1982-83 was estimated to be worth more than \$13 million dollars. Red foxes have been part of this country's legends, folklore, and literature since it was settled. Current information shows that the red fox's lifestyle differs dramatically from what these sources have suggested.

### ***What Makes a Fox a Fox***

There are three fox species in Kansas, the red fox, the swift fox, and the gray fox, and they are easily distinguished. The red fox is a small, slender, long-legged canine weighing between 6 and 12 pounds. Red foxes measure about 36 inches in length. They have a 12-inch tail that they use for balance and for warming the face while sleeping. The white tip on the red fox's tail distinguishes it from the other two foxes. The upper body of a red fox is reddish-yellow and is darkest on the shoulders and back. The legs have black stockings. The belly and chin are white. The ears are often trimmed in black, and there are varying amounts of black on the tail. Several color phases of red fox are found, especially in colder regions. Red foxes may be black, silver, cross (dark cross on the shoulders), bastard (bluish gray), or Samson (no guard hairs).

The gray fox is slightly smaller than the red fox. It weighs 7 to 11 pounds and is 24 inches long plus a 12-inch tail. There is little color variation in gray foxes. They have a salt-and-pepper coat with buff underfur and rusty yellow sides, legs, feet, and backs of the ears. The reddish sides will occasionally cause people to refer to the gray fox as a red fox. However, the primary color of the coat is gray, and the bushy tail has a conspicuous black stripe and black tip. The ears are also black-tipped.

The swift fox is the smallest species of fox in Kansas. It weighs 4 to 6 pounds, stands about 12 to 14 inches high and is 28 to 32 inches long from tip of nose to end of tail. This species has a buffy gray to yellow-tan coloration. Like the gray fox, it has a black-tipped tail. Unlike either the red fox or gray fox which have dark-colored feet, the swift fox has tan-colored feet. Swift fox also have a characteristic black spot on the side of the snout.

There is some question whether the red fox is native to North America. Some believe the red fox was native in the northern part of this country but scarce or absent in most of the vast hardwood forests where gray foxes were common. Others believe the North American red fox originated from the European red fox, which was introduced into North America around 1750. Nonetheless, the red fox is the most widely distributed carnivore in the world. It occurs throughout the United States and Canada. Red foxes are also native to Europe,

Asia, and the Soviet Union. Red foxes have been introduced into Australia.

The gray fox occurs in much of eastern North America. Its range extends into Mexico, Central America, and Venezuela. Gray foxes are not found in mountainous areas in the northwestern United States and Canada, parts of the Great Plains, and eastern Central America.

The swift fox is the native fox of the short-grass prairies of North America. The historical distribution of the species extended from Alberta, Canada to northwestern Texas. Historically, the swift fox occurred on the high plains of western Kansas. Occasionally dispersing animals were observed in the mixed-grass prairies of central Kansas. Extensive conversion of the short-grass prairie to cropland has fragmented the distribution of the species and eliminated it from some areas. The scavenging behavior of the swift fox also makes it susceptible to poison baits used in coyote control programs.

Swift fox are a creature of the open plains. Their habitat preference is for short-grass prairie on level or moderate rolling terrain. Unlike the other canids of Kansas, swift fox use ground dens year-round. They therefore occur on sites suited for burrowing and avoid extensive areas of sandy soil, shallow soils, or rocky areas. They also tend to avoid areas with dense brush or areas with rough terrain, which provides cover for their major predator in Kansas, the coyote.

### ***Cover, Food, Water, and Space Needs***

Red foxes are adapted to a variety of habitat types. They prefer diverse habitats consisting of intermixed cropland, rolling farmland, brush, pastures, mixed hardwood forests, and edges of open areas that provide suitable hunting ground. They select areas where there is a diversity of habitats with plenty of edge. Red foxes may also inhabit suburban areas, particularly parks, golf courses, cemeteries, and large gardens. Thus, red foxes are generally animals of open land and forest edges.

Gray foxes have similar habitat preferences in that they prefer a diversity of fields and woods rather than a large tract of homogeneous habitat. The basic difference between the two species is that gray foxes prefer woodlands and brushlands more than red foxes do. Gray foxes like 200 to 300 acres of mixed hardwood forests, woodlands, and brush areas interspersed with open fields or croplands. Large dense stands of timber should have patches of open areas to be useful for gray foxes.

Swift fox feed on a variety of small mammals, birds, reptiles, and insects. Cottontail rabbits and jackrabbits are frequently an important prey resource for swift fox. Insects may comprise half of the diet during August and September. Carrion may be critical during the winter when much of their warm season prey is unavailable.

An adequate number of denning sites is important for good fox habitat. Red foxes may dig their own dens. However, they usually use an abandoned woodchuck or badger burrow.

The same den may be used for generations. In some cases, red foxes prefer strip cover for den sites. Gray foxes use rocky outcrops, hollow trees, brushpiles, or rockpiles for dens.

Foxes are opportunistic carnivores but will feed on a wide variety of animal and plant material depending on what is available in a local area. Small mammals, birds, fruits, and insects comprise the bulk of the fox's diet. When rabbits and mice are plentiful, they make up the bulk of the red fox diet. Red foxes often store food in caches. Caching is necessary when their prey become scarce because they must feed on a regular basis.

Besides rabbits and mice, the red fox may eat squirrels, young opossums, raccoons, skunks, housecats, woodchucks, weasels, mink, muskrats, shrews, moles, songbirds, crows, quail, grouse, ducks, turkeys, chickens, geese, hawks, owls, bird eggs, turtles and their eggs, and insects. The red fox also eats plant foods, such as grasses, sedges, nuts, berries, pears, apples, grapes, and other fruits as well as corn, wheat, and many other grains.

Gray fox food habits are similar to but not as well-known as those of the red fox. Availability plays a major role in what is eaten. Animal matter appears to be most important during the winter, whereas insects and fruits are important summer foods. Cottontail rabbits and rodents are the usual dietary staples.

Home range for the red fox is the area used by a family unit consisting of a mated pair and the pups. The size of the home range for the red fox varies from 500 to 2,000 acres, and the territory used by red fox families is usually within 1 mile of the den. The den is the focal point of all activities until the end of the denning season. The male red fox assumes responsibility for territory defense. Scent markings play a role in defining the territory and reinforces the male's familiarity within its own home range.

Gray fox home ranges vary among areas ranging from 35 to more than 6,000 acres. The average is about 1 to 2 square miles. Home ranges are a function of prey availability, population density, and the diversity of habitats present.

The home range of swift fox varies with swift fox density and prey availability. Home ranges as small as 200 to 500 acres have been recorded for swift fox in Colorado, while the movement pattern of swift fox on a study area in Nebraska ranged from 2.6 to 11.1 square miles. Swift fox disperse during the fall or early winter of their first year of life.

## ***Reproduction***

The breeding season for the red fox occurs between December and March, whereas the breeding season for the gray fox occurs between January and April. Breeding occurs earlier in the south and later in the north. The gestation period is between 51 and 54 days for red fox, 63 days for gray fox. One to ten pups (the average is five for red fox, four for gray fox) are born April through May. Newly born pups remain at the den for the first month of life. Red fox parents may move

the pups from one den to another as many as three times before the pups are 6 weeks old. Litters are sometimes split, with half the litter in one den and half in another. By the 12th week, the pups begin to explore different parts of their parents' home range during daylight hours. By mid-September or early October the young begin to disperse.

Swift fox in Kansas probably breed during February or March. The gestation period is approximately 50 days. An average litter size is four to five pups. The pups do not emerge from the natal den until they are about a month old.

During the breeding season, the male and female remain in the territory until the pups are raised. The male defends the territory and brings food to the vixen until the pups can be left alone for short periods of time. Both the parents hunt for food, with the vixen returning to nurse the pups during the day. Both parents remain with the pups until they leave in the fall.

Red and gray foxes live about four to five years in the wild. They are subject to a variety of mortality factors. The three most prevalent causes of death are hunting, trapping, and roadkills. Mange occurs in red fox populations and can result in death. Two viral diseases, rabies and distemper, can also result in death. Gray foxes appear to be especially vulnerable to canine distemper. When contracted, distemper is suspected to be nearly 100 percent fatal to this species.

Much remains to be learned about survival and mortality of wild swift fox. Predation by coyotes has been a significant factor in some restoration projects and at studies of established populations. Other predators include golden eagles, badgers, and bobcats. Activities of man may lead to significant mortality. Shooting and trapping may be important in some areas, however, these activities can be regulated. Activities like poisoning programs directed toward other species, introductions of new diseases and parasites from dogs, roadkills, and conversion of short-grass prairie to cropland are more difficult to evaluate but potentially more serious to the swift fox population.

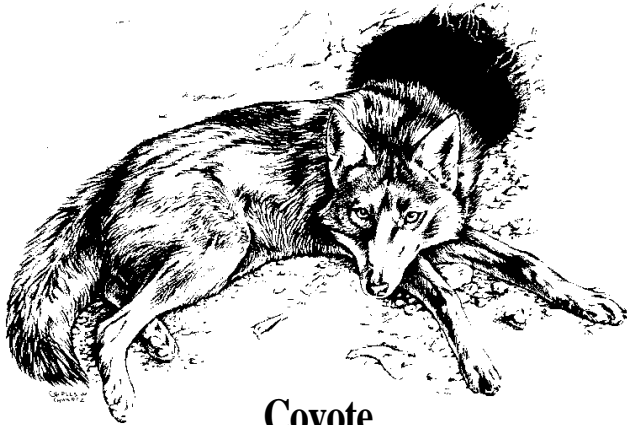

**Coyote**

The word coyote means “barking dog” and is derived from the Aztec word coyote. The Native American people called the coyote the “song dog” because of its characteristic howls. In recent years coyotes have been a valuable fur resource in northern states. It is estimated that about 500,000 coyotes are harvested in this country each year. At an average pelt price of \$20, this resource is worth more than \$10 million each year. Coyotes are also beneficial in catching numerous mice, rats, and other agricultural pests. Although the ability of coyotes to control populations of mice and rats is not proven, they probably help moderate extreme fluctuations in prey populations. Many people also enjoy seeing coyotes and listening to the call of the song dog.

Coyotes can be predators of domestic sheep. It has been estimated that the federal government spent \$8 million to control coyotes in 1971, and individual states spend up to \$1 million each per year for coyote control. However, studies have shown that producers who use good animal husbandry techniques, such as fencing, guardian dogs, and corralling at night, can reduce domestic livestock losses by as much as 90 percent.

### ***What Makes a Coyote a Coyote***

Coyotes are sometimes confused with other wild animals such as foxes. Coyotes can be distinguished from these two members of the dog family by their larger body size. They may also be confused with dogs because adult coyotes may resemble a German shepherd with some noticeable differences. Coyotes have a thin muzzle, a bushy tail usually carried at a downward angle, and constantly erect ears. Although coyotes occasionally breed with dogs producing the “coydog” hybrid, research has shown that this phenomenon is rare. Thus, most coyote-looking animals observed in the wild are probably coyotes.

The size and weights of coyotes are commonly overestimated because their long furry coat masks a bone structure lighter than that of a dog. Kansas coyotes weigh between 20 and 40 pounds (the average female weighs 29 pounds, and the average male weighs 33 pounds) and measure between 48 and 60 inches long.

There is great variation in the coloration of coyotes. They range in color from almost pure gray to rufous (red). Pure black (melanistic) coyotes are rare but have been documented. Coyote coats usually vary from buff-yellow to reddish-yellow brown. The belly and throat areas are light gray or white. A mane of black-tipped hairs is typical among coyotes as are black-tipped hairs over the upper tail and rump.

Before the 1940s, the coyote was an animal of the deserts, mountains, and plains of the west and southwestern United States. Today, coyotes are found throughout the United States, Canada, and Mexico. Coyotes are very adaptable and opportunistic animals. The coyote occurs in every county, and densities are highest in counties having large areas of pastures, agricultural cropland, and reclaimed strip-mined areas intermingled with woodlots.

### ***Cover, Food, Water, and Space Needs***

Coyotes are flexible and adaptable in their habitat requirements. They will live almost anywhere adequate food is available. Coyotes use a variety of cover types to escape from dogs or man, to protect their pups, or to use as daytime resting sites. These cover types include brush-thickets, tall grass, or wooded areas. Woodlots in association with creek drainages are most often used by coyotes during daylight hours. These woodlots are thought to be the center of activity for coyotes in large areas of open farm country. Thus, the number and location of woodlots in this habitat might determine the numbers of coyotes there.

Coyote dens may be found in a wide variety of places, such as brush-covered slopes, steep banks, rock ledges, thickets, and hollow logs. Denning sites are usually in a remote area away from human activity.

Coyote feeding areas are as varied as the prey they consume. Since coyotes are opportunistic feeders, the type of feeding habitat changes according to the abundance and availability of prey. Cropland, pastures, hayfields, and overgrown fields are used extensively by coyotes when feeding on mice and rabbits, an important coyote food source.

Coyotes will eat whatever is easiest to obtain and consistently present. Rodents, rabbits, and similar-sized mammals, and carrion make up the bulk of the coyote winter diet. Livestock carrion is an important winter food source. Carrion is thought to support higher coyote densities that might not exist if livestock producers regularly practiced proper disposal techniques. Coyotes eat vegetable matter, fruits, and insects in substantial amounts in the summer. Other food items they eat include deer, pronghorn, birds, ground squirrels, cats, and fish.

Coyotes will drink water from any available source, such as ponds, stock tanks, creeks, rivers, or lakes. Water must be readily available for these animals.

Coyotes are basically solitary. In most cases, coyotes travel and feed as individuals or in pairs, hunting small prey.

Family groups of six to eight coyotes may be seen. Coyote pairs or family groups live in distinct, nonoverlapping territories. Territory size is thought to be influenced by coyote densities and prey availability. Territory boundaries are maintained by scent marking. Fighting between coyotes is not a common means of territorial defense; however, coyotes will occasionally attack and kill intruding coyotes. Coyotes that are unable to establish a territory may continue to travel in a nomad manner until an area becomes available. A small percentage are nomads and do not respect territorial boundaries. Territory size varies from 1 to 10 square miles. Most activity is confined to a much smaller area.

Coyotes are active day and night but will travel more extensively and for long periods during night hours. Most activity occurs around sunrise and sunset. This is also the time when most feeding and social interactions occur. During the daytime, coyotes usually rest or bed in different locations each day. In good habitats with plenty of prey, coyote densities during the pup-rearing season can vary from one to five coyotes per square mile. Average population density is usually one adult coyote per square mile.

### ***Reproduction***

Coyotes mate in February or early March and give birth to three to seven young 60 to 63 days later. Female coyotes may breed with one or more males but form a pair bond with only one male. The same pair may breed from year to year but not necessarily for life. Pups are born in late March through May. The pups weigh about one-half pound at birth. An average litter is four to six pups. Pups are cared for by the mother and possibly other "helpers," usually young of the previous year. The male helps by providing food for the young. Pups nurse for five to seven weeks and begin eating regurgitated food at 3 weeks of age. Their eyes open at about 14 days, and their teeth erupt at about the same time. Pups reach adult size by 9 months of age.

Pups begin leaving the areas of their birth in August through December. In the fall, many young coyotes move from their birth territories in search of a place to settle. These movements often cover 10 to 50 miles. During this time, mortality is high, and as many as 70 percent of the young coyotes may die.

Food supply appears to determine the number of females that breed and particularly affects the number of yearling females that breed. If the food supply is good, more females will breed due to their healthier condition. Many female coyotes do not breed until their second year.

Coyotes die from many natural and man-made causes. People are responsible for the majority of deaths among coyotes older than 5 months of age. Coyotes are also susceptible to a number of canine diseases, including canine distemper, hepatitis, mange, parvovirus, and rabies. Average annual mortality rates are of 30 to 40 percent for adults and 70 percent for juveniles.



### **Skunks**

We are all familiar with the unmistakable odor that skunks discharge when provoked. This obnoxious odor causes humans to fear and avoid skunks. The word skunk originates from the Algonquin Indians and refers to the spraying of musk. However, despite our dislike for them, skunks are, for the most part, beneficial to us because they feed on insect and rodent pests. The value of wild-captured skunk pelts in the North American fur trade during 1982-83 was estimated to be more than \$870,000.

### ***What Makes a Skunk a Skunk***

Two species of skunks live in Kansas, the striped and the eastern spotted skunk. The striped skunk is the most abundant. Skunks are often referred to as polecats, civet cats, hydrophobia cats. The spotted skunk is incorrectly called a civet cat because of its similarity to Old World civets. Skunks are not closely related to either true civets or to cats.

Skunks are members of the weasel family. All members of this family (skunks, river otters, long-tailed weasels, least weasels, badgers, and mink) have characteristic musk glands, which in the skunk are responsible for its obnoxious odor. The scent, produced by two internal musk glands located at the base of the tail, is usually released for self-defense. Before spraying the thick, volatile, oily, sulfur-containing compound, skunks usually stamp their front feet rapidly and growl or hiss. They generally raise their tail as a warning before releasing any scent. The fluid is released in a fine spray directed accurately up to 10 feet, but they can spray up to 20 feet. Skunks can discharge the spray several times within a short period. The fluid is painful if it gets in a person's eyes and may cause temporary blindness for up to 15 minutes.

Few animals can be confused with these typically black-and-white spotted or striped animals. Striped skunks are short, stocky mammals about the size of a domestic house cat. They typically have a triangular-shaped head tapering to a blunt nose, a large bushy tail, and large feet equipped with well-developed claws. Their color pattern is

typically characterized by two prominent white stripes down the back in a coat of jet black fur. The amount of white on the back varies tremendously from just a patch on the head to stripes covering the entire back. Adult striped skunks weigh between 4 and 10 pounds although individuals weighing more than 12 pounds have been recorded. Striped skunks measure between 23 and 28 inches in length.

Spotted skunks are about one-half the size of striped skunks. They measure 10 to 27 inches long and weigh 1 to 4 pounds. Males are generally larger than females. The animal appears to be much more weasel-like and is readily distinguishable by white spots in front of each ear and on the forehead and four to six broken white stripes on the back. These animals are much more agile than striped skunks, and they are capable of climbing trees.

The striped skunk can be found throughout the southern half of Canada, the United States except the desert southwest, and northern Mexico. Opening up of forest lands and the increase in agricultural lands in the early 1900s benefited the striped skunk and allowed the animal to expand its range. The striped skunk can be found in every Kansas county. Skunks are most abundant in areas that have tracts of riparian forests.

Eastern spotted skunks range from northeastern Mexico through the central United States to the Canadian border. They can be found throughout the southern United States. They were abundant during the early 1900s but are now classified as a threatened species in Kansas.

### ***Cover, Food, Water, and Space Needs***

Skunks favored haunts include rolling hayfields, fencerows, brushlands, woodland edges, weedy fields, rocky outcrops, wooded ravines, stone walls, abandoned buildings, and drainage ditches. Home to a skunk is an underground den that may be found in vacant buildings, under house porches, culverts, brushpiles, tree stumps, lumber piles, or in abandoned fox or woodchuck burrows. The dens are lined with leaves, hay, or grasses. Skunks use a variety of dens for loafing during the day, for giving birth and raising young, and for periods of inactivity during the winter. During the day, skunks usually sleep in the den although during the warmer months they may bed in vegetation along fencerows, hayfields, or pastures. During the winter months, skunks may remain inactive in the den for a period of days or weeks. Skunks do not hibernate but become inactive during cold weather, relying on stored body fat to get them through the winter. Several skunks may share the same den during winter to conserve body heat.

Skunks must have free drinking water available in their home range. Striped skunks may also use aquatic habitats when they feed on crayfish, fish, frogs, or snakes.

Skunks are opportunistic feeders, feeding on both plant and animal material. Favorite skunk foods are grasshoppers, crickets, beetles, wasps, cutworms, and insect larvae. When insects are not available, skunks will eat mice, rats, shrews,

moles, chipmunks, and other small mammals. They will also eat reptiles, amphibians, fish, fruits, and garbage. Occasionally they will feed on poultry and the eggs of ground-nesting birds. Most of a skunk's diet consists of small mammals and insects considered injurious to man.

Skunks are nocturnal, becoming active from sunset to slightly after sunrise. Female skunks are not great travelers, whereas male skunks may travel up to four or five miles a night during breeding season. Normal skunk home ranges vary from 1 to 1.5 miles. During the breeding season, males extend their activity to include times during the day. They are reluctant to flee when disturbed. This is the time when skunks are often struck by cars. Skunks are not territorial and tolerate other skunks in their range. This nonterritoriality allows for concentrations of breeding skunks in localized areas.

### ***Reproduction***

The breeding season for skunks in Kansas begins in late January when males begin searching for females near winter dens. Males are polygamous and will mate with several females, sometimes in succession. Females are receptive to males during their one heat period which lasts nine to 10 days. Mating triggers ovulation about 42 hours after insemination.

After a 62- to 66-day gestation period, young striped skunks are born in May and June. Usually five to nine young striped skunk kits are born in a litter. After a 45- to 60-day gestation period, spotted skunks give birth to one to six young (the average is four). The kits are blind, wrinkled, thinly furred, and totally helpless at birth. The kits weigh about 1 ounce at birth. After two to four weeks, their eyes open, and the young skunks are able to discharge fluid from their scent glands. Kits will nurse for six to seven weeks and follow the female on hunting trips until they are 2 months old. Young skunks are weaned at about 2 months of age. Families break up during August and September when the young leave to find their own homes.

Skunks die from a variety of causes. Coyotes, foxes, bobcats, great horned owls, and barred owls relish skunks. Starvation may also cause some skunks to die over winter. A variety of diseases and parasites are common to skunks. Rabies and leptospirosis are the primary diseases responsible for deaths in skunks. Skunks are a primary source of infection for other species of animals involving these two diseases.

Skunks are very susceptible to rabies. Because they can become locally abundant and can transmit rabies to other mammals, skunks cause concern for human health and livestock safety. Rabies is a serious viral disease that infects many types of warm-blooded animals. Rabies is generally spread by direct contact with an infected individual, usually by biting.

When a skunk becomes infected with the rabies virus, it may go unnoticed for a period of time. Symptoms may not appear for weeks or months. During this time, the infected

animal may transmit the virus to the other animals it contacts. In the final stages of the disease, skunks may seem tame or listless, show signs of excessive salivation, become unusually aggressive or nervous, wander about during the daytime, and show little fear of humans.

Skunks are usually docile, slow-moving animals, and their main period of activity is from sunset to sunrise. If you notice a skunk acting strangely (aggressive or nervous, wandering in the daytime, or tame and listless), do not approach it. Parents should warn children never to approach or pet a skunk or any other wild animal. If you live in an area with a large skunk population, all pet dogs and cats and important livestock should be vaccinated for rabies. Do not keep skunks or other wild animals as pets because they cannot be effectively immunized against the disease. Furthermore, they may have contracted rabies at an early age and be infected, yet fail to exhibit symptoms for some time.



## Weasels

The weasel is an absolutely fearless hunter. It will attack a man or any other creature that tries to interfere with feeding. Weasels are generally considered beneficial because they are efficient predators and a terror to rats and mice. Only the occasional individual is a nuisance that will invade a henhouse and kill all the poultry it can find.

### *What Makes a Weasel a Weasel*

The only two weasels known to occur in Kansas are the long-tailed and the least weasels. The long-tailed weasel is the most common and widely distributed weasel in North America. It is easily recognized as a long, slender animal with rather large, rounded ears. Pelt color is a rich brown on the sides and back with a light-colored neck and belly. The tip of the tail is black. Long-tailed weasels measure 11 to 17 inches in length, and the tail may account for one-quarter to one-half

of that length. Adult male weasels weigh between 5 and 16 ounces, whereas adult females weigh between 3 and 9 ounces. The long-tailed weasel can be distinguished from the least weasel which has a short tail without the distinctive black tip.

The least weasel is best recognized by its small size (less than 10 inches) and its extremely short tail (about 1 inch in length). The least weasel is the smallest member of the weasel family weighing between 1 and 3 ounces. Other than the differences noted above, the least weasel resembles the long-tailed weasel in general appearance.

Long-tailed weasels are found throughout the United States and southern Canada except in parts of the desert southwest. Neither species is abundant in Kansas. The least weasel is a northern animal, ranging from Alaska and Canada southward into northern Illinois and Indiana, Ohio, and in the higher Appalachians to North Carolina. Records of least weasels in Kansas are rare; however, recent information suggests least weasels can be found in the northern and eastern parts of the state.

### *Cover, Food, Water, and Space Needs*

Long-tailed weasels are more adaptable than other weasel species. They can be found along forest edges, brushlands, fencerows, stream banks, and agricultural areas where there are adequate den sites, food, and water. Dens are often modified chipmunk burrows, a crevice or hole in a stone wall, a cavity beneath a stump, or some other secluded place. The nest is made of densely packed grass and lined with mouse and shrew fur. The burrow may contain skins and bones of animals that were eaten. As with most weasels, food abundance (particularly small voles and mice) is important in determining the abundance of weasels.

Long-tailed weasels are more food generalists than are least weasels. Long-tailed weasels eat chipmunks, voles, deer mice, and an occasional snake, frog, insect, fruit or berry, or ground-nesting bird and their eggs. Least weasels specialize in eating very small prey. Voles and deer mice are most frequently eaten although shrews may be eaten when other prey are not available. Least weasels have a different hunting technique compared to long-tailed weasels. Least weasels, small enough to chase small voles and mice into runways and burrows, spend a great deal of time hunting in these areas. Weasels have voracious appetites and will eat one-third of their body weight every day. Free-standing water also appears to be an important habitat component as long-tailed weasels have been recorded as "great drinkers."

Weasels are generally active at night; however, they can be seen hunting for chipmunks or meadow voles in daylight hours. They are active summer and winter. Their gait is a bounding gallop with the back arched so that the hind feet are placed just behind or on top of the prints of the front feet. This makes a distinctive track of groups of four prints or occasionally two prints side by side with the next tracks 12 to 30 inches away. A weasel will climb a tree when chasing its



prey but does not seem at ease there. Weasels are inquisitive creatures, emerging from hiding to investigate the slightest noise and often standing erect to get a better view.

Home ranges of long-tailed weasels are larger than those of least weasels. Home range size depends on prey availability. In areas with plenty of food, home ranges typically vary from 25 to 60 acres. If food is scarce, home range size may increase up to 200 to 400 acres. Least weasels have smaller ranges. If food is readily available, home range size can be as small as 5 acres; however, typical ranges vary from 10 to 40 acres. Good habitat with an abundant prey source can support up to 25 or more long-tailed weasels per square mile.

### **Reproduction**

Long-tailed weasels breed in July through August. Least weasels breed year-round. The time of breeding and the number of litters that least weasels produce per year is related to prey abundance. If prey are abundant, least weasels may have two or three litters in a year. Long-tailed weasels exhibit delayed implantation like other members of the weasel family. Least weasels do not exhibit delayed implantation. Long-tailed weasels have a long gestation period (205 to 337 days) and give birth to six to eight young in April. Least weasels have a gestation period of about 35 days and give birth to four to five young.

Young weasels are born naked, blind, and helpless. Their eyes do not open until they are 35 days old. By 3 months of age the young are nearly mature. Young females may breed in their first summer; males do not breed until 2 years of age.

Little information is available on the mortality of weasels. Great horned owls, barred owls, rough-legged hawks, foxes, coyotes, and domestic cats have been observed eating weasels. Weasels are also susceptible to a variety of parasites, including fleas, ticks, mites, and worms. Weasels are also susceptible to canine distemper.



## **North American Badger**

The North American badger is generally associated with prairies, parklands, and arid lands of Kansas.

Although badgers provide some assistance to farmers by eating rodents, problems associated with digging may overshadow those benefits. Badgers cause problems similar to those caused by prairie dogs, groundhogs, and other burrowing animals. This may include destruction of earthen water structures and damage to farm machinery (resulting from machinery contacting burrows).

### **What Makes a Badger a Badger**

Badgers are uniquely adapted for digging. Badgers dig to feed on burrowing rodents, to escape from predators, and to den. Because of their unique adaptations for digging, badgers are unlikely to be mistaken for any other mammal. This stout, compact, loose-skinned animal has short muscular legs with long-curved foreclaws (which can measure up to 2 inches long) and short, shovel-like hind claws. The toes are partially webbed and adapted for removing loose soil while digging. Badgers have small rounded ears located on a wedge-shaped head. Adult badgers weigh between 16 and 24 pounds (the average is 18 pounds). Adult females are smaller and average 14 pounds. Male badgers are larger than females and measure 23 to 35 inches in length.

The coloration of a badger varies from silverish gray to yellow on the back and sides with a gray or light cream-colored belly. The lower legs and feet are black. Badgers have a conspicuous white stripe extending from the nose to the end of the neck. The side of the face is white with a black triangular patch in front of the ears. The resulting black-and-white color pattern is called the “badges.”

The North American badger ranges across the western and north-central United States, southwestern Canada, and into south-central Mexico. Although the badger is limited to this continent, other badgers closely related to this species can be found throughout the world.

### ***Cover, Food, Water, and Space Needs***

The badger is an animal of open country where cover is usually limited. Thus, the animal uses ground dens instead of vertical cover as a means of escape. Badgers are usually found in pastures or on rangelands with light to moderate cover that are occupied by burrowing rodents. Food abundance and availability may be important in how plentiful badgers are in an area.

Dens play an important role in the ecology of the badger. Dens serve as a central site for food storage, daytime resting, birthing, and feeding. Badgers avoid soil types, such as extremely rocky or sandy soil, that prevent burrowing. Dens vary in their characteristics but generally the dens in which females give birth and raise young are more complex than other types of dens. These dens usually have a main tunnel with multiple branches. Two rejoining secondary tunnels are used for animals to pass each other; several dead-end side tunnels are used to deposit droppings; and chambers layered with vegetation house the kits.

Badgers are efficient predators adapted for preying on burrowing and semiburrowing animals, such as ground squirrels, chipmunks, prairie dogs, woodchucks, and rabbits. They also eat mice, insects, and occasionally reptiles, birds, and bird eggs. When feeding, badgers use their highly sensitive nose to locate prey in burrows and then dig these animals out. Badgers are such efficient predators that animals they prey on may show periodic population crashes.

Badgers are usually active at night, feeding from sunset to sunrise. They usually remain underground during daylight hours. Badgers are not hibernators but will limit their aboveground activity to warmer winter periods. Badgers may remain 2 to 12 days underground during the winter. Territoriality of badgers is not completely understood. Females do not appear to be territorial because their home ranges overlap those of other females and males. Home ranges of adult males may or may not overlap one another. Home range size varies from 300 to 500 acres although home ranges as large as 2,100 acres have been reported. Badger densities vary with habitat, geographical regions, and the seasons. Densities range from 1 per 13 square mile.

### ***Reproduction***

Like other mustelids, badgers have delayed implantation. Thus, the breeding season for badgers ranges from May to August, peaking in late July and August. Badgers are polygamous breeders. Short mating bonds may occur during the breeding season but will dissolve after breeding, leaving the female to care for the young. Females give birth to one to five young in late March or April after a true gestation period of about six weeks.

Young badgers feed on milk for 5 to 6 weeks after birth. Cubs may leave the den for short periods when they are 4 to 5 weeks old. The family remains together until breakup in summer. A majority of juvenile females breed, but juvenile

males do not breed until the following year.

Although young badgers are occasionally preyed upon by bears, coyotes, dogs, golden eagles, and cougars, man seems to cause the greatest mortality among badgers through roadkills, shooting, farming accidents, and trapping.

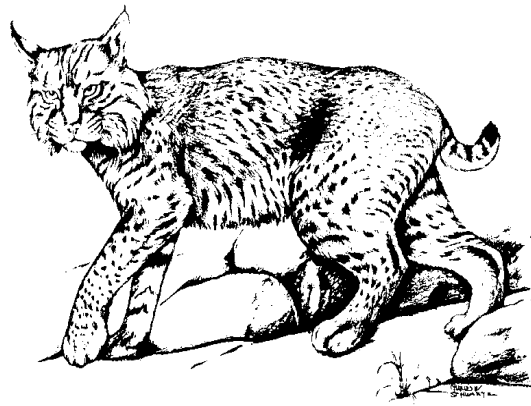

### **Bobcat**

Often called a bay lynx, barred bobcat, catamount, lynx cat, wildcat, or cat of the mountains, the bobcat is one of the most elusive of all furbearing animals. Before the 1970s, bobcat pelts were relatively worthless, and most bobcats were killed in the name of predator control. However, fashion trends changed, and larger spotted cats, such as the jaguar, were protected by several laws, creating a demand for bobcat pelts. During 1982-83 bobcat pelts sold for more than \$11.5 million.

### ***What Makes a Bobcat a Bobcat***

The bobcat slightly resembles a housecat but is about twice its size. The bobcat also has longer hind legs and a shorter tail. Male bobcats are larger than females and weigh between 16 and 35 pounds. Males measure about 34 inches long complete with a about a 5-inch tail. Females measure about 31 inches in length and weigh between 8 and 33 pounds. The height of a bobcat at the shoulders varies between 20 and 23 inches.

The bobcat's general coloration is yellowish or reddish brown streaked or spotted with black or dark brown. The guard hairs are black-tipped. Its belly is white with black spots, and there are several black bars along the inside of the forelegs. The tail has several dark bands that become more distinct at the tip. The underside of the tail is whitish. Bobcat fur is dense, short, and very soft. No true color phases occur, but all-black (melanistic) bobcats have been reported. There is tremendous individual color variation within the bobcat's range.

Bobcats have a short, broad face with ruffs of fur on each side. The ears are prominent and pointed with a tuft of black hair at the tip. The back of the ear is black with a central white spot. The bobcat has sharp, retractable claws. There are four

toes on the hind feet and five on the front. The tracks show only four toes on the front feet because the fifth toe is raised.

Historically, the bobcat could be found in all the lower 48 United States, parts of southern Canada, and northern Mexico. It was eliminated from many densely populated and heavily farmed midwestern states by the early 1900s. The animal appears to be doing well in the United States, except in the midwest and central Atlantic coast around Delaware and New Jersey. It seems to be expanding its range into many areas that previously supported only lynx.

Bobcats occur throughout Kansas. The highest densities occur in the southeast and central parts of the state in the Chautauqua Hills, Flint Hills, and Osage Plateau regions.

### *Cover, Food, Water, and Space Needs*

The bobcat is adapted to a wide variety of habitat types, from swamps to deserts and mountain ranges. The only habitat type not used is intensively farmed agricultural land where rocky ledges, swamps, and forested tracts do not occur. They prefer areas with a dense understory vegetation and a large prey base. Prey abundance, protection from severe weather, availability of rest areas, dense cover, denning sites, and freedom from disturbance are the key features in bobcat habitat.

In some areas, ledges are critical habitat. Ledges appear to be activity centers that provide protective cover, protection from harassment, and an area for courtship activities. These areas may also serve as gathering grounds for these normally solitary cats.

Another important feature of bobcat habitat is denning sites. Bobcats use cliffs, rocky ledges, or rock piles as denning sites. The animals use these areas for refuge from harassment, for breeding and raising young, and for shelter. Brushpiles, hollow trees, and logs may also serve as rest areas and dens. Bobcats need more than one den site within their home range because females with young often use more than one denning site.

Bobcats, like many predators, are opportunistic and will attempt to take almost anything available. Insects, fish, reptiles, amphibians, birds, and mammals have been reported in bobcat diets. Mammalian prey is the most important group, and the bobcat is best adapted to prey on rabbits. The cottontail rabbit appears to be its principal prey throughout its range.

The bobcat most frequently kills prey weighing between 1 to 12 pounds (rabbits, large rodents, opossum-sized animals). The second most frequently taken prey weighs more than 12 pounds (beaver and deer). The final groups of prey weigh between one-third to 1 pound (squirrels and rats) and less than one-third pound (mice, shrews, and voles).

The size of bobcat home ranges varies according to prey availability and abundance, sex, season, climate, and topography. However, bobcat ranges tend to be large, dictating low densities throughout much of its range. Typical densities average about one animal per 3 to 5 square miles. Home ranges typically vary from 1 to 80 square miles.

Bobcats are territorial, and resident animals confine their movements and activities to specific ranges. Transient bobcats (young or sexually immature adults) may exhibit long-range, erratic movements but move into home ranges that are vacant due to the death or removal of a resident animal. Male home ranges are usually larger than those of females (two to five times as big) and may overlap several female home ranges. Females tend not to overlap ranges of other females. Nevertheless, bobcats appear quite adaptable; female ranges have overlapped each other, and some resident bobcats have even shifted home ranges altogether.

The animal's social structure and territory boundaries are maintained in part by a complex system of scent marking using urine, feces, the anal glands, and scraping with the feet. As part of this system, bobcats may use "scratching trees" (dry, barkless snags) to help define territories.

### *Reproduction*

Female bobcats generally come into heat once a year during the spring (February or March) although bobcats may breed from January through July. Females may breed their first reproductive season, whereas males generally do not become sexually mature until 2 years of age. About 62 days after breeding (the range is 50 to 70 days), female bobcats give birth to one to four (usually two) kittens in a crude nest made of leaves and moss located in a rock crevice, hollow tree, or similar shelter. At birth, bobcat kittens' eyes are closed; they begin suckling immediately while the mother licks their fur dry. They open their eyes at about 10 days of age. The female does not leave the young for two days, sustaining herself by eating the placenta, feces, and any stillborn kittens. By the end of the fourth week, the kittens begin eating solid food. The kittens are weaned by the seventh or eighth week but remain with the mother until autumn or winter.

Most mortality in bobcat populations is in the juvenile age class. Forty to 50 percent of all juvenile bobcats do not reach 2 years of age. The most important factor affecting this mortality is food availability. These young cats are most susceptible to death during the period when they leave their mother and the establishment of their own home range. Bobcats are not commonly preyed upon although foxes, coyotes, owls, and adult male bobcats will prey on kittens. Because of the solitary nature of bobcats and their propensity for changing denning and resting areas frequently, bobcat populations have not succumbed to die-offs as a result of heavy parasitic infections.

## Questions for Chapter 36

1. What are the cover requirements for beavers, muskrats, and river otters?
2. Briefly outline the ups and downs of beaver numbers since America was settled, and explain how the beaver has affected the settlement of this country.
3. What appears to be a major factor limiting raccoon abundance in Kansas?
4. Describe the different habitat requirements of red, swift, and gray foxes.
5. What are the differences in bobcat and coyote habitat requirements? What types of foods do bobcats and coyotes eat?
6. How are the food habits and cover requirements of opossums, foxes, skunks, weasels, and badgers different (or similar)?

Name \_\_\_\_\_



## Chapter 37

# Predators

*F. Robert Henderson*

**E**ach of us can probably recall a place that supported high populations of game but now only small numbers remain. The place may look the same, but we don't remember seeing so many hawks then as now. So we decide the hawks cleaned the game out of our favorite hunting place. There are all sorts of ideas like this one. Predators and predation is simple enough. Predators are animals that eat other animals. The act of one animal killing another is predation. Not all animal predators are thought of by people as true predators. Take for instance a field rodent, like the cotton rat. Cotton rats break and eat the eggs of many ground-nesting birds. There are many types of animals that are predators, not just coyotes, bobcats, and hawks.

We've learned that management of wildlife is a very complicated undertaking and so is the understanding of predators and predation. All living organisms are dependent upon the environment for their existence. Generally, the best way people can make things better for wildlife is to provide as large a block of native habitat as possible, and let nature take its course. Habitat is the place where animals live, including the land, water, and plants. If people have an interest in trying to increase one kind of animal more than another kind native to that habitat, then it gets more complicated. When we change the habitat by introducing food, plants, or building a pond, some wild animals may flourish while others may be negatively effected.

The smaller habitat blocks become, the greater affect predation can have on a single species. A good example of this was taught to me when greater prairie chickens were studied in northern Nebraska, and it was determined that over-grazing by domestic livestock had depleted the prairie chickens' nesting habitat. People wanted to have more of these birds, so it was decided to fence cattle out of small blocks of native grass rangeland to give the chickens a place to nest. It worked, the prairie chickens went to the patches of grass, but so did a lot of different kinds of predators. The bull snake population jumped 300 percent on the fenced sites compared to unfenced, adjacent grasslands. These high-quality nesting sites were chosen by many hungry predators as prime spots for food-searching forays. As a result, the greater prairie chicken and their nests and/or their broods were more frequently detected and taken as was previously possible in the larger, over-grazed blocks. Within a short time, no prairie chickens could be found in that area.

Many years passed and prairie chickens returned to that area but only after people started using grazing systems that

allowed enough grass for ground-nesting birds. The new grazing system also resulted in more pounds of beef being produced than before. Had we declared war on the bull snakes, coyotes, skunks, and several other predators that found and ate prairie chicken eggs, we would still be killing these animals and still not have prairie chickens.

A "predator problem" can be increased by people with good intentions who seek to reduce one kind of animal being killed by another kind of animal. This is true because predators affect not only prey but also other predators within a given area. Prior to their extreme suppression by people, the large predators like the Plains grizzlies, the wolves, and pumas held medium-sized predators like foxes, coyotes, and bobcats at relatively low-density levels. But, some people decided these medium-sized predators were "varmints" and launched massive programs to reduce their numbers. Then, small predators like raccoons, opossum, badgers, and striped skunks increased.

It is usually true that ground-nesting birds in small blocks of prime nesting habitat are subject to heavy nest predation. Furthermore, predator control can reduce nest and brood losses, but such an undertaking should be well thought-out and the cost and benefits weighed carefully.

First, a person should determine what species are being lost. Along with this determination, the person should set a goal as to what is to be accomplished and for what purposes. Since, undoubtedly, dollars are going to be involved, how much can be spent, and how many dollars return will this expenditure bring back? Another way to evaluate the control effect is to ask how many additional hours of recreational hunting might result from the gain in bird numbers compared to hours lost to trapping for furbearers and/or hunting for coyotes. Very few people who embark on missions of predator control consider these points.

A problem in studying predation is that predation is seldom witnessed by humans. Until recently, the chances were small of seeing the pursuit, capture, and kill of prey animals. Such sightings were dependent upon occasional observations. With the advent of high-tech devices like Trail Master® remote cameras, and video, it is now possible to record predation as it occurs. A device such as one of these could help a person identify which species are responsible for a decline in a favorite species.

How much do predators need to sustain life for one day? I know a lot of sheep producers who believe that every coyote spends every hour looking for a sheep to kill. Some

stockmen claim coyotes can eat a 500-pound steer in one night. How many coyotes? This is most often left to speculation. It is a good idea to learn as much as you can about the predator and as much as you can about the prey animal as well.

Predators are many things; most are opportunistic. That means they will eat whatever they can find when they are hungry. Many predators are also omnivorous feeders. That means they eat a wide variety of foods. Coyotes are both opportunistic and omnivorous; they eat watermelons, grasshoppers, June bugs, other insects, other fruit, grass, grains, fish, frogs, rats, calf droppings, and just about everything else. Coyotes can hold around 7 pounds of material in their stomach at one time and may stuff their stomachs after several days without food. People who have kept coyotes in captivity tell me that about 1 pound of food a day will keep a coyote in good health. Coyotes in the wild don't eat every day, they are adapted to "wait out" storms or other periods when food is scarce.

Availability of prey is a strong factor in determining what most predators eat on a given day. Once they locate a ready source of seasonally abundant food, predators will return often to that source. That reminds us about the story of the prairie chickens. If an individual predator is able to rely on a particular kind of food over an extended period of time, that individual predator may become a specialist in catching and killing that kind of prey. To carry this point further, a predator that develops specialization will tend to teach their off-spring how to obtain that same food.

A few kinds of predators are more specialized in taking prey than the typical opportunistic predator. The black-footed ferret is thought to be one such predator, because they typically prey only on prairie dogs.

One of the biggest drawbacks to humans' efforts to artificially reduce the population of one kind of predator is the high likelihood that another kind of predator will increase as a result. In areas of the northern Great Plains, studies have shown that red foxes increased when coyotes were decreased by people's direct efforts.

There can be more red fox numbers in a given area under natural conditions than there can be numbers of coyotes. The home ranges of red fox are smaller than the coyote's home range. Therefore, a red fox will have a greater chance of hunting out more ground-nesting birds than a coyote, since the coyote typically covers more area without searching it as intensely as the fox. Foxes, having a smaller home range, would be more likely to learn and take advantage of behavior patterns of their preferred prey.

As we study this manual, we learn of ways to change habitats for purposes we feel are good. We always need to remember when we do this we may also create habitat for

other species, including predators and prey species. That, in turn, could result in even greater losses of a preferred species to predators than was the case originally.

Understanding the habits of predators helps us protect the kinds of wildlife we want. The impact of hawks and owls on game bird populations in Kansas have been discussed a lot. When we develop the protective cover for game birds, we need to remember that birds of prey are sight-hunting. The sight of birds of prey is somewhat comparable to the nose-hunting land predatory mammals. One of the most limiting factors to ring-necked pheasants in western Kansas is good winter cover. Prime cover that protects against winter snow storms and hides them from predators. Removing dead trees near travel lanes, roosting fields, or feeding areas would help reduce predation by hawks and owls by eliminating their perching platforms.

As people can see, a medium-sized predator, such as a coyote, is much easier to see than a cotton rat. Very few people realize the coyote is a foe of cotton rats and that cotton rats destroy more quail nests than coyotes. By destroying the coyote, more cotton rats survive, and they, in turn, may destroy more quail nests than the coyotes would have destroyed.

There might be times when predator control could be beneficial when undertaken for a short time to remove an individual wild house cat, coyote, or other animals. However, predation of game is normal and necessary. Your best bet is to provide large blocks of native habitat, changing it only when you are confident the change will directly help the species you intend to increase. Look at predation more as a secondary factor, a factor that often you cannot do much about. A good rule of thumb is to carefully consider a predator control action to be sure you do not do more harm than good. The severity of predation on native wildlife populations seems to depend more upon the number of individuals present and on the quality of the habitat.

You will find over time that good habitat does not always produce abundant populations of wildlife. But without habitat, you can be sure of very low to zero populations of wildlife. Observations of predators usually indicate high numbers of prey animals, therefore, good habitat. Just remember it is difficult to have abundant prey species without predation, and you can't have either without good habitat. The ideal approach is to provide good habitat to support abundant populations of both prey animals and predators.

If you encounter a situation where you decide to take direct action against a predator, a good reference book for you is titled, "Great Plains Handbook on Prevention and Control of Wildlife Damage," Scott Hygnstrom, Editor, Room 202, Natural Resources Hall, University of Nebraska, Lincoln, NE 68583-0819.

## Questions for Chapter 37

1. What are predators?
2. How does habitat size impact predation?
3. What factors influence what predators eat?
4. What is an opportunistic predator?
5. How does habitat minimize predation?

Name \_\_\_\_\_





## Chapter 38

# Mussels, Madtoms, Bats, and Darters: Kansas' Endangered Species

Richard Hannan

The term “wildlife” is defined differently by each person hearing or using the word according to their experience and interest. To the child growing up on a Kansas farm, the term may bring to mind the pesky woodrat living under the barn, the white-tailed deer that bounds out of the timber when startled, or the bullfrog croaking on a summer night from the pond. To the person living in a suburb outside one of our cities, wildlife may be the brilliant male cardinal visiting a bird feeder, the fox squirrel scampering up a backyard tree, or the occasional cottontail rabbit raiding their newly planted garden. The city-dweller, on the other hand, may not really think much about wildlife because to them animals are seen only on an infrequent trip to the zoo or hiding in library books.

The term wildlife encompasses all of these images and more. But in most cases, whoever is defining the term generally uses examples of animals that are relatively common or familiar to them. This chapter will present an aspect of wildlife that is not as well understood or familiar—endangered species. The discussion will not be limited to animal species but will include the plight of all plants and animals that are in danger of being lost from Kansas or the world.

Before we begin, let's first set the stage by defining some terms and providing some background about the diversity of living organisms on Earth. Throughout this chapter the term **species** will be used. For our purposes, the term means all of the different kinds of plants, animals, and microorganisms living on our planet. Another term commonly used in this chapter is **extinction** or the permanent loss of a species from Earth.

Biologists estimate that somewhere between 5 and 30 million species of plants, animals, and microorganisms

share the Earth with us today. Unfortunately, only about 1.5 million species have been identified and described. These include mostly the larger, more obvious organisms like fish, amphibians (frogs and salamanders), reptiles (snakes and lizards), birds, mammals, and flowering plants. The majority of the unrecorded species are smaller, less understood organisms like insects and microscopic plants and animals.

A breakdown of the organisms documented by scientists includes 20,000 fish species, 9,100 amphibian and reptile species, 8,600 bird species, 4,100 mammal species, 1,200,000 insect species, and 250,000 flowering plant species, as well as millions of microorganisms and other plants and invertebrates (Table 1).

A quick glance at Table 1 shows the approximate number of plant and animal species known to exist in the United States and in Kansas. Kansas is a very diverse state that harbors a great wealth of habitats and, consequently, is home to a great number of plant and animal species. More than 13 percent of the total number of freshwater fish, amphibians and reptiles, and birds found in the United States call Kansas home.

## *Isn't Extinction a Part of Life on Earth?*

If there are millions of species of plants, animals, and microorganisms on Earth, why does it matter if a species becomes extinct? This commonly asked question can be answered in a number of ways, but we first should look at the nature of life on Earth. Ever since life began on Earth, new species have developed and others have become extinct. New species may develop relatively rapidly or through a gradual process, but in any case, the result is a transformation of one

**Table 1. Number of species known in the world, the U.S., and Kansas.**

	Fish	Insects	Amphibians/ Reptiles	Birds	Mammals
Number species on earth	20,000	1,200,000	9,100	8,600	4,100
Number species in U.S.	950 <sup>1</sup>	92,600 <sup>2</sup>	454	1,683	800
Number species in Kansas	123	>15,000	97	424	86
Percent of U.S.	12.9%	16%	20%	25%	10%

<sup>1</sup> Freshwater fish

<sup>2</sup> Includes the United States and Canada

organism into two or more new or different kinds of organisms. This process, called **speciation**, normally occurs over the course of tens of thousands, or even millions, of years as a result of **selective environmental pressures**, changes in the world to which an organism must adapt or perish.

The development of new species and their extinction are both natural processes that have always occurred. Some scientists estimate that more than a half billion species have lived at one time on our planet. If this estimate is anywhere near correct, today’s stock of species represents about 2 percent of that total.

Scientists also believe that the percentage of species going extinct has generally remained constant except for periodic episodes where for some reason this rate was accelerated. These eras of mass extinctions have occurred at intervals of 26 million years over the last 250 million years.

Modern man has raised the rate of extinction dramatically (Table 2). This has generally not been caused by the direct destruction of species although there have been cases where unregulated hunting did contribute to the extinction of some animals.

The primary reason for extinctions caused by humans is habitat destruction. As the human population has grown and technology has increased our ability to modify the environment, the extinction rate has skyrocketed. If current trends continue, human-caused extinctions of animals will rival the greatest natural catastrophe of the last 65 million years—the loss of the dinosaurs. The current rate of loss of plant species is unprecedented in the history of the Earth. Based on work in tropical rainforests, research shows that losses may be up to 10,000 times the rate of extinction before human intervention. In real terms, this means that as much as 20 percent of all species on Earth today will vanish by the year 2000.

We have only to review the history of Kansas to see why the loss of species has increased. Our state was a vast unspoiled wilderness when first explored. Grasslands clothed nearly 50 million acres and contained some of the most

luxuriant native grass stands in North America. Additionally, nearly 1.6 million acres of wetlands completed the mosaic of landscapes that greeted settlers (see Chapters 10 and 11).

Today, Kansas is home to more than 2.4 million people, and homes, farms, towns, surface mines, and reservoirs have been carved out of the wilderness. Much of the prairie has been plowed and converted to cropland. Fifty percent of the wetlands have been destroyed.

It is no wonder that the herds of bison that made the ground quake, the flocks of passenger pigeons and Carolina parakeets that clouded the sky, and the hairlip sucker that required crystal-clear water to survive are now extinct or no longer exist in Kansas. The human pressures exhibited in our state have been multiplied thousands of times to produce the unprecedented rate of extinction now eroding the biological heritage of planet Earth.

### *What is an Endangered Species?*

The term “endangered species” became part of our language in 1973 when Congress passed the Endangered Species Act. This act was developed in an effort to curb the increasing rate of extinction of the world’s living organisms. The act and its amendments have been called the most comprehensive legislation ever passed to enhance the preservation of endangered organisms (Table 3). This act empowered our government to identify those species of plants and animals that should be classified as endangered or threatened based on scientific evidence. **Endangered species** are those that will probably become extinct unless protected, and **threatened species** are likely to become endangered in the foreseeable future.

The act prohibited anyone from harassing, capturing, or killing any protected species. It also required that federally authorized, funded, or implemented actions not jeopardize the continued existence of a listed species. Other sections of the act provided guidelines for the recovery of

**Table 2. Why species become threatened and extinct and the percentage of extinctions and enthratenments attributed to each cause.**

Cause	Percentage of Species			
	Birds		Mammals	
	T*	E**	T	E
Habitat destruction and modification	15	30	19	29
Unregulated hunting	42	24	33	43
Introduction of exotic predators	15	11	17	8
Introduction of nonpredatory exotic animals	4	3	6	6
<b>Total percentage</b> of extinctions and enthratenments as a result of human actions	76	68	75	86
Natural causes	24	32	25	14
<b>Total</b>	100	100	100	100

\*T = Threatened

\*\*E = Extinct

**Table 3. Important provisions of the Federal Endangered Species Act of 1973 as amended.**

Section	Intent, Purpose, Action
2	defines the purpose and intent of the law to include the following: a) various species of fish, wildlife, and plants have been rendered extinct because of economic growth and development without adequate conservation. b) many species are in danger of extinction. c) these species are of aesthetic, ecological, educational, historic, recreational, and scientific value to the nation. d) the United States has pledged within the international community to conserve species facing extinction. e) the federal government needs to encourage, through incentives, activities by states and others to develop and maintain conservation plans.
3	defines the terms used throughout the act
4	defines the process of listing a species as threatened or endangered; designates critical habitat for the species; after a species is listed, the U.S. Fish and Wildlife Service is responsible for adopting a recovery plan that is not legally binding but acts as a management framework.
5	authorizes the acquisition of land.
6	directs the federal government to cooperate and consult with the states concerning the management and preservation of a listed species.
7	directs federal agencies to conserve species and to ensure that their activities do not jeopardize the continued existence of a listed species or adversely modify its critical habitat. The U.S. Fish and Wildlife Service (USFWS) must review proposed activities and if an activity will jeopardize a listed species or its habitat, the USFWS must recommend reasonable and prudent alternatives.
8	defines the role of federal agencies in cooperation with foreign countries in conserving, preserving, and managing endangered or threatened species.
9	defines prohibited acts including removal or destruction on federal lands and interstate transport.
10	describes exceptions to the law including undue economic hardships, Alaska natives, and experimental populations.
11	provides for civil and criminal penalties; civil penalties of not more than \$25,000 or imprisoned for not more than 6 months, or both for each violation. Criminal penalties of not more than \$50,000 or imprisoned for not more than one year, or both.

**Remaining**

**Sections** administrative details.

listed species and encouraged the development of complementary programs by the states.

It was Congress's intent not only to stem the tide of species extinctions but to recover listed species to the point where protection was no longer needed. The intent has never been to stop any commercial, urban, or industrial development or management activities.

To date, approximately 1,100 species have been designated as endangered or threatened worldwide (Table 4). However, more than 3,600 have been identified as candidates for endangered or threatened status and are awaiting official action. Unfortunately, the listing process is hampered by inadequate funding and staff shortages, and at least 34 plant and animal species have become extinct while awaiting review for protection under the act.

Passage of the act has brought the plight of endangered species to daily newspapers and popular magazines and elevated public awareness about the consequences of extinction to man. This recognition has also resulted in the

development of endangered species programs or laws to protect rare plants and animals in nearly all states.

The Nongame and Endangered Species Conservation Act, a Kansas Endangered Species Law, was enacted in 1975 to comply with the federal law. In 1979 a federal-state cooperative funding agreement was established to cost share endangered and threatened species project.

The Kansas Department of Wildlife and Parks (KDWP) establishes the rules, regulations, and programs (including acquisition of land or aquatic habitat) necessary for the conservation of Threatened and Endangered (T&E) Species and Species In Need of Conservation (SINC). Specifically, the Department determines whether a species of wildlife indigenous to the state is threatened or endangered because of any of the following factors: 1) the present or threatened destruction, modification, or curtailment of its habitat or range; 2) overuse of the species; 3) disease or predation; 4) inadequacy of existing protective regulations; or 5) other natural or artificial factors affecting its continued existence within Kansas.

**Table 4. Federally protected endangered and threatened plants and animals found in the U.S. and foreign countries as of June 1991.**

Species Type	Endangered		Threatened		Total
	U.S.	Foreign	U.S.	Foreign	
<b>Animals</b>					
Mammals	55	249	8	22	334
Birds	73	153	12	0	238
Reptiles	16	58	18	14	106
Amphibians	6	8	5	0	19
Fish	53	11	33	0	97
Snails	4	1	6	0	11
Clams	39	2	2	0	43
Crustaceans	8	0	2	0	10
Insects	13	1	9	0	23
Arachnids	3	0	0	0	3
<b>Plants</b>	190	1	60	2	256
<b>Total</b>	460	484	155	38	1137*

\* Separate populations of a species that are listed both as endangered and threatened are tallied twice.

**Table 5. Threatened (T) and endangered (E) species status.**

Common Name	Scientific Name	Federal	State
<b>Invertebrates</b>			
Flat floater mussel	<i>Anodonta suborbiculata</i>		E
Rabbit's foot mussel	<i>Quadrula cylindrica cylindrica</i>		E
Western fanshell mussel	<i>Cyprogenia aberti</i>		E
Neosho mucket mussel	<i>Lampsilis rafinesqueana</i>		E
Elktoe mussel	<i>Alasmidonta marginata</i>		E
Bleedingtooth mussel	<i>Venustaconcha pleasi</i>		E
Slender walker snail	<i>Pomatiopsis lapidaria</i>		E
Scott riffle beetle	<i>Optioservus phaeus</i>		E
American burying beetle	<i>Nicrophorus americanus</i>	E	
Rock pocketbook mussel	<i>Arcidens confragosus</i>		
Fluted-shell mussel	<i>Lasmigona costata</i>		
Butterfly mussel	<i>Ellipsaria lineolata</i>		
Ouachita kidneyshell mussel	<i>Ptychobranthus occidentalis</i>		
<b>Fish</b>			
Arkansas River shiner	<i>Notropis girardi</i>		E
Pallid sturgeon	<i>Scaphirhynchus albus</i>	E	
Sicklefin chub	<i>Hybopsis meeki</i>		E
Speckled chub	<i>Macrhybopsis aestivalis tetranemus</i>		E
Arkansas darter	<i>Etheostoma cragini</i>		T
Chestnut lamprey	<i>Ichthyomyzon castaneus</i>		T
Flathead chub	<i>Hybopsis gracilis</i>		T
Hornyhead chub	<i>Nocomis biguttatus</i>		T
Neosho madtom	<i>Noturus placidus</i>	T	
Redspot chub	<i>Nocomis asper</i>		T
Silverband shiner	<i>Notropis shumardi</i>		T
Blackside darter	<i>Percina maculata</i>		T
Sturgeon chub	<i>Macrhybopsis gelida</i>		T
Western silvery minnow	<i>Hybognathus argyritis</i>		T
<b>Amphibians</b>			
Cave salamander	<i>Eurycea lucifuga</i>		E
Graybelly salamander	<i>Eurycea multiplicata griseogaster</i>		E
Grotto salamander	<i>Typhlotriton spelaeus</i>		E
Central newt	<i>Notophthalmus viridescens louisianensis</i>		T
Dark-sided salamander	<i>Eurycea longicauda melanopleura</i>		T
Eastern narrowmouth toad	<i>Gastrophyrne carolinensis</i>		T
Green toad	<i>Rana clamitans melanota</i>		T

**Table 5. Threatened (T) and endangered (E) species status. (Continued)**

Common Name	Scientific Name	Federal	State
Northern spring peeper (frog)	<i>Pseudacris crucifer crucifer</i>		T
Strecker's chrous frog	<i>Pseudacris streckeri streckeri</i>		T
Western green toad	<i>Bufo debilis insidiosus</i>		T
<b>Birds</b>			
Bald eagle	<i>Haliaeetus leucocephalus</i>	E	E
Black-capped vireo	<i>Vireo atricapillus</i>	E	E
Eskimo curlew	<i>Numenius borealis</i>	E	E
Least tern	<i>Sterna antillarum</i>	E	E
Peregrine falcon	<i>Falco peregrinus</i>	E	E
Whooping crane	<i>Grus americana</i>	E	E
Piping plover	<i>Charadrius melodus</i>	T	T
Snowy plover	<i>Charadrius alexandrinus</i>		T
White-faced ibis	<i>Plegadis chihi</i>		T
<b>Mammals</b>			
Black-footed ferret	<i>Mustela nigripes</i>	E	E
Gray myotis (bat)	<i>Myotis risescens</i>	E	E
Eastern Spotted Skunk	<i>Spilogale putorius interupta</i>		T
<b>Reptiles</b>			
Broadhead skink (lizard)	<i>Eumeces laticeps</i>		T
Checkered garter snake	<i>Thamnophis marcianus marcianus</i>		T
Common map turtle	<i>Graptemys geographica</i>		T
New Mexico blind snake	<i>Leptotyphlops dulcis dissectus</i>		T
Northern redbelly snake	<i>Storeria occipitomaculata occipitomaculata</i>		T
Texas longnose snake	<i>Rhinocheilus lecontei tessellatus</i>		T
Texas night snake	<i>Hypsiglena torquata jani</i>		T
Western earth snake	<i>Virginia valeriae elegans</i>		T

**Table 6. Species in need of conservation in Kansas**

Common Name	Scientific Name	Common Name	Scientific Name
<b>Invertebrates</b>			
Cylindrical papershell mussel	<i>Anodontoides ferussacianus</i>	Texas mouse	<i>Peromyscus attwateri</i>
Snuffbox mussel	<i>Epioblasma triquetra</i>	Townsend's big-eared bat	<i>Plecotus townsendii pallescens</i>
Wartyback mussel	<i>Quadrula nodulata</i>	<b>Reptiles</b>	
Spike (Lady-finger) mussel	<i>Elliptio dilatata</i>	Alligator snapping turtle	<i>Macroclmys temminckii</i>
Wabash pigtoe mussel	<i>Fusconaia flava</i>	Rough earth snake	<i>Virginia striatula</i>
Fat mucket mussel	<i>Lampsilis radiata conspicua</i>	Western hognose snake	<i>Heterodon nasicus</i>
Yellow sandshell mussel	<i>Lampsilis teres</i>	Timber rattlesnake	<i>Crotalus horridus</i>
Washboard mussel	<i>Megaloniais nervosa</i>	Eastern hognose snake	<i>Heterodon plathirhinus</i>
Round pigtoe mussel	<i>Pleurobema coccineum</i>	Glossy snake	<i>Arizona elegans elegans</i>
Squawfoot mussel	<i>Strophitus undulatus</i>	<b>Birds</b>	
Fawnsfoot mussel	<i>Truncilla donaciformis</i>	Bobolink	<i>Dolichonyx oryzivorus</i>
Deertoe mussel	<i>Truncilla truncata</i>	Cerulean warbler	<i>Dendroica cerulea</i>
Ozark emerald dragonfly	<i>Somatochlora ozarkensis</i>	Curve-billed thrasher	<i>Toxostoma curvirostre</i>
Gray petaltail dragonfly	<i>Tachopteryx thoreyi</i>	Ferruginous hawk	<i>Buteo regalis</i>
Prairie mole cricket	<i>Gryllotalpa major</i>	Golden eagle	<i>Aquila chrysaetos</i>
<b>Fish</b>			
Banded darter	<i>Etheostoma zonale</i>	Short-eared owl	<i>Asio flammeus</i>
Banded sculpin	<i>Cottus carolinae</i>	Henslow's sparrow	<i>Ammodramus henslowii</i>
Yellow-throated warbler	<i>Dendroica dominica</i>	Ladder-backed woodpecker	<i>Picoides scalaris</i>
<b>Mammals</b>			
Eastern chipmunk	<i>Tamias striatus</i>	Long-billed curlew	<i>Numenius americanus</i>
Franklin's ground squirrel	<i>Spermophilus franklinii</i>	Mountain plover	<i>Charadrius montanus</i>
Pallid bat	<i>Antrozous pallidus bunkeri</i>	Chihuahuan raven	<i>Corvus cryptoleucus</i>
Southern bog lemming	<i>Synaptomys cooperi</i>	Black tern	<i>Chlidonias niger</i>
Southern flying squirrel	<i>Glaucomys volans volans</i>	Black rail	<i>Laterallus jamaicensis</i>
		Red-shouldered hawk	<i>Buteo lineatus</i>
		Whip poor will	<i>Caprimulgus vociferus</i>

To meet these responsibilities, an Endangered Species Steering Committee, with work groups of species experts, was established. This committee submitted 137 wildlife species as candidates for endangered or threatened status, with 26 species accepted in the final lists published in May 1978. The T&E lists, with advice from non-agency specialists, were amended to 24 species in 1980, 45 in 1987, 46 in 1989, and 57 in 1992. The state endangered list includes 24 species (see Table 5). The national Endangered Species List includes nine of these species. The State Threatened includes 32 species of which two of these species are on the national Threatened Species List. The SINC list includes 69 species (see Table 6). Plants are not included on the state T&E species or SINC lists since no statutory provisions allow for their consideration and placement. Two plants occurring in Kansas, the Western prairie-fringed orchid and Mead's milkweed, are on the federal Threatened list.

Activities related to T&E and SINC wildlife center around four main areas: research, education and information, regulations, and management. The Chickadee Checkoff is the primary funding source for research. Most projects focus on the biological status and distribution of species on the T&E and SINC lists. KDWP is authorized to protect critical habitats for listed T&E species potentially impacted by state or federally permitted or government funded projects.

### ***Why Do Species Become Rare and Extinct?***

How often have you heard your parents or grandparents say, "I remember when we used to get a lot of snow in the winter, but now we just don't get as much." Today, newspaper articles nearly each week mention global warming, hurricanes, volcanic eruptions, and devastating floods. The Earth is constantly changing: mountains are formed and slowly erode away, ice ages come and go, the oceans rise and fall, and continents drift apart and collide. Stability on Earth is short-lived and certainly not the rule.

A look at any roadcut shows how much our state has changed. The limestone rocks underlying much of Kansas were formed by the accumulation of tiny lime-bearing shells of oceanic organisms that lived in the shallow seas flooding our state millions of years ago. Oil and gas, important minerals in Kansas, were formed when much of our state was a humid, lush swamp. Kansas' rock formations provide evidence that the Earth and our state has changed much through time.

### **The Earth is an Ever-Changing Place**

What does all this have to do with why species become rare or extinct (Table 7). Extinctions occur because species cannot adapt to environmental changes. When the thermometer drops to zero during winter, we grumble as we turn up the thermostat in our homes and bundle up in thick sweaters and coats before going outside. Animals and

**Table 7. Factors that predispose a species to become endangered.**

<b>Factor</b>	<b>Example</b>
Narrow habitat requirements	Indiana bat
Restricted distribution (particularly islands or land separated by bodies of water)	Puerto Rican parrot
Economically important species	Javan rhinoceros
Species living in international waters	Atlantic green sea turtle
Species of large size (particularly carnivores)	Grizzly bear
Species that have limited reproductive potential (limited number of offspring, long gestation or incubation period, extensive parental care)	Virginia big-eared bats, California condor
Highly specialized species (due to physiological, behavioral, or physical specializations)	Giant panda

plants cannot protect themselves in the same ways from weather. They must be able to endure the cold, become dormant, or migrate to warmer climates, or they will die.

Every species adapts to its environment or perishes. Some have very broad tolerances and survive over large areas (see Chapter 3). Others have very narrow requirements and are restricted to small areas. In most cases, we cannot explain why such variation occurs, but it does. We do know that every species is the product of tens of thousands or millions of years of adaptation and interaction with the environment and that its characteristics and life requirements have become genetically programmed.

### **Factors in a Species' Vulnerability**

Some factors that determine the vulnerability of a species to extinction are total population size, geographical distribution, reproductive ability, ecological relationships with other species, habitat, and genetic characteristics. As is true throughout nature, all of these factors interact to determine the vulnerability of any species to extinction. Examples of some of these characteristics are highlighted in the following paragraphs.

Some species are naturally rare or uncommon. They may have always been uncommon and restricted to small areas. Other species may be rare because they have started down the path leading to extinction. Many people commonly argue that species now endangered were on their way to becoming extinct without man's help. This argument is wrong in all but a very few cases. One fish found in Kansas and nowhere else in the world appears to be naturally rare. The Neosho madtom is found only in the main stems of the Neosho watershed. This species lives in a very specific type of habitat in a very limited area. In all likelihood, this fish was rare before European settlers came to Kansas. The Neosho madtom is listed as a Federally Threatened species.

Freshwater mussels (clams) are vulnerable to extinction because of their unusual reproductive system and habitat requirements. Kansas streams historically harbored more than 100 species, more kinds than all other states except Alabama and Tennessee. Many streams were literally paved with mussels. Several species were restricted to certain river drainages and most required clean, well-oxygenated streams.

Mussels have a unique life cycle. At the appropriate time of year, males release sperm into the water which is then carried downstream by the current to fertilize egg-bearing females. Fertilized eggs develop into *glochidia*, parasitic embryonic mussels that must attach to fish to grow. This is very tricky because many mussel species apparently parasitize or attach to only one or two fish species. To help them attract this "host" fish, a select group of mussels have structures that resemble a potential mate or food item for the fish. If successful in attaching to the appropriate host, the glochidium will feed off the fish for a short period after which it drops off as a juvenile mussel. The young mussel will grow into an adult if it can avoid predation and find suitable habitat.

The environmental requirements of mussels and their complicated reproductive cycle are liabilities in habitats altered and degraded by humans, making these ecologically important animals vulnerable to extinction. Unfortunately, that is what has happened to much of Kansas' mussel fauna. Because of pollution, impoundment of our rivers, channelization, and habitat loss, half of our native mussels are rare or on the verge of extinction.

Many species that are rare in Kansas are common in other states. This happens because Kansas may be at the fringe of a species' range.

There are other examples where the reverse is true, where species are common in our state but rare elsewhere. In these situations, where the fate of a species may not rest with its status in a given state, protection is still warranted to retain the organism as part of a state's natural heritage.

Certainly, some species are rare by their nature. However, the majority of species are rare because humans have drastically altered their environment. Remaining natural lands are being bulldozed, plowed, paved, and permanently flooded daily. As humans continue to alter the world to suit their needs, other species have progressively less room to survive. It is no wonder that many species are rare or have become extinct.

### ***Why Care about Extinctions Caused by Humans?***

"Why should I care that species are going extinct?" is a universal question most people ask when confronted by the issue of endangered species. Discussions about this issue often become impassioned when they involve a controversial development project. Recently, a major controversy has developed in the Pacific Northwest over the cutting of our ancient forests and the loss of the northern spotted owl.

In Kansas, less publicized debates occurred regarding the listing of the Broadhead skink as a state threatened species and the proposed impoundments on the South Fork. The controversy in each of these issues centered around the fact that some people saw no value or reason to protect species that they believe add nothing to humans or their existence.

All species are valuable, and mankind should be concerned about the potential loss of even the lowest form of life. Most people acknowledge that humans are obligated to be good stewards of the planet. What right do humans, just one of perhaps 5 to 30 million species, have to extinguish other species? All too often we are good stewards only if it is convenient and apparently costs us nothing.

The beauty of organisms with which we share the Earth is another reason for their preservation. We spend billions of dollars to acquire, protect, and enjoy beautiful works of art and music. The world is outraged when vandals attack centuries-old sculptures and paintings. But have you ever looked closely at a dragonfly, a woolly worm, or a prothonotary warbler? Their beauty and intricacy certainly rival the finest works of arts.

Aside from arguments that species should be protected out of a sense of compassion or because of their beauty, there are economic reasons for preserving the Earth's species. In the mid-1980s, scientists isolated a compound called cyclosporine from a plant belonging to the mushroom family. It was found that cyclosporine had the ability to suppress the rejection response of people undergoing tissue transplants. Since the introduction of this drug, the success of heart, lung, liver, kidney, and bone marrow transplants has increased dramatically. This drug has saved thousands of people and has improved their quality of life. If we had eliminated the plant from which cyclosporine is produced, thousands of people now living normal lives would have died.

Every species is an encyclopedia of genetic information, a reservoir of biologically active compounds. If we consider that the lowliest bacterium may have 1,000 genes and that many flowering plants and some animals have 400,000 genes, every species is a hidden treasure chest of information that may be important to humans. Thus far, we have barely started to unlock the potential benefits of the world's plants and animals.

Current estimates suggest that one in three Americans will contract some form of cancer in their lifetime. Consider for a moment that only about 35,000 of the Earth's 250,000 flowering plant species have been screened for anti-cancer activity. We truly have just begun the quest that could save lives. Nearly 25 percent of all prescription medicines in the United States contain active ingredients originally extracted from plants. With the extinction of every species, we may be recklessly destroying the opportunity to cure diseases like leukemia, heart disease, multiple sclerosis, or AIDS.

Another of society's ills that plants and animals might be able to cure is world hunger. The majority of humanity relies on only three plant species (corn, rice, and wheat) for



their basic nourishment, and only about 20 species provide the major source of food for all of mankind. In human history, only about 3,000 plant species have been used for food, or about 1 percent of all plant species on Earth. Scientists estimate there are at least 75,000 edible plant species. If we consider animals, nearly all protein that humans consume from domesticated animals comes from less than a dozen species. How many more animals could be domesticated? While most people in the United States are generally well fed, many of our citizens and much of the world is starving. Again, we must ask, are we shutting the door on the starvation problem by accelerating the extinction of the world's plants and animals?

Perhaps the most compelling argument to conserve species is that all life is interwoven into the delicate fabric that supports life on Earth. It is impossible to eliminate one species without affecting the whole. All species are part of the food web that cycles nutrients and energy (Chapter 3). Each plays a role in maintaining the quality of our atmosphere and water, the productivity of our soils, and the moderation of our climate.

Each species can be likened to the bricks of a house. Every brick contributes to the support and integrity of the house. What would happen if you slowly and randomly started to remove bricks? A few bricks could be removed with minimal results. However, as more bricks are removed, cracks would develop in the walls, the roof would sag, and leaks would appear. At some point that we cannot predict, the entire structure would collapse, and the house would turn to rubble.

No one knows just how many species can be lost without the crumbling of our ecosystem and the end of life on Earth as we know it. No one can predict when the catastrophe will strike. However, it is certain that we are eroding the fabric of life with each species we push to extinction. The truly sad part of this situation is that all of the benefits these organisms provide man are free if we allow all species to survive and function in a healthy ecosystem.

### ***What Are Some of Kansas' Endangered Species, and Where Do They Live?***

Species currently protected under the Endangered Species Act and under review for possible protection under the act are listed in Tables 5 and 6. The plants and animals on these lists are rare, and you may have never heard of them, much less seen many of them. But if you wanted to see one, where would you look? In general, most of the rare and endangered species in Kansas are found in wetlands, rivers, and streams.

#### **Wetlands**

The United States Fish and Wildlife Service estimates that about one-third of Federally Endangered species depend on wetlands during some part of their life. In Kansas, approximately one-third of the species on T&E or SINC list

are associated with wetlands. Many wetland-dependent species are rare because humans have dramatically altered or destroyed much of our nation's wetland resources. These areas, known by such terms as bogs, bottoms, low ground, marshes, swamps, and a host of other local names, were viewed as "wastelands" for most of our nation's history. Federal and state programs were implemented to ditch, drain, and convert these areas to "productive land." We did a very good job. Today, it is estimated that less than 50 percent of our wetlands remain in the lower 48 states and less than 50 percent in Kansas. Thus, it is easy to understand that wetland plants and animals are rare because wetlands are rare.

Wetlands are now recognized as important ecosystems that provide significant benefits to society. Although federal laws encourage the protection of our remaining wetland resource, many of these laws are weak, and enforcement is often lacking. Wetlands continue to be degraded or lost. Many states have taken on the challenge of protecting wetlands by enacting laws and protective programs, but Kansas is not among these. Some of the rare species that inhabit our wetlands are:

- the whooping crane and hooded merganser, birds that nest in wetlands;
- the alligator snapping turtle, which may weigh up to 300 pounds;
- the eastern narrowmouth toad, found only in Cherokee County;
- a host of amphibians, birds, and reptiles.

Because of the importance of this endangered habitat, separate chapters (Chapters 10 and 11) on wetlands have been developed for this manual and should be referred to for more information.

### ***What Can Landowners Do to Help Endangered Species?***

Kansans interested in protecting rare plants and animals on their property first should determine the kinds of habitats present. If any of the habitats described earlier (wetlands, caves and cliffhines, prairies and glades, northern habitats, or rivers or streams) are found, rare or endangered species *may* live on your property. However, the presence of any of these habitats only suggests the potential for rare and endangered species.

#### **Have an On-Site Inspection**

Their presence can only be determined by an on-site inspection by a qualified biologist. In lieu of an examination of the property, the KDWP or Kansas Biological Survey can determine if rare organisms are known in your county or nearby area (their addresses are found at the end of this chapter). Any request for information should include a map and general description of the area of interest.

You should note that the distribution of plants and animals can be very complex and many times is poorly understood. Therefore, nearly all land that has not been developed intensively has some potential for harboring rare species. If these organisms are found on your land, technical advice will be provided to assist you in their protection.

### Be Aware of Pesticide Use

Because some pesticides may harm endangered and threatened species, the Environmental Protection Agency (EPA) has been developing an Endangered Species Protection Program (ESPP) to protect vulnerable species and their habitats from the effects of pesticides. EPA began developing this program in 1982 and published an initial proposal in 1987 and 1988. The proposal has since undergone revision and now concentrates on providing the best protection for threatened and endangered species themselves. This effort was begun to comply with Section 7 of the Endangered Species Act as amended. To minimize impacts on pesticide users, EPA will evaluate pesticides with emphasis on lower application rates as opposed to complete prohibition of use.

Kansas endangered and threatened species most likely to be affected by pesticide use include bats and mussels. Adverse pesticide use can affect these species for several reasons; thus, precautions should be taken when spraying pesticides. An example would be the hazard of pesticides contaminating streams which are homes to mussels. Under provisions of the Endangered Species Act, pesticide misapplication may be considered either harassing or harming wildlife in the context of definitions provided in the act.

The following is a general description of how ESPP will work (Table 8). The first component is called labels and bulletins. Generic label statements instruct pesticide users to consult county bulletins for use limitations. Bulletins will be updated as needed. These county bulletins are not yet available.

The next part of ESPP is state involvement. Some states are developing their own endangered species protection programs; others are developing education and training programs and maps which define affected habitats.

The third component of EPA's ESPP is a pilot program. Interim programs conducted from 1989 through 1991 will evaluate the feasibility of the program and determine the best methods for distributing information and gaining cooperation. Sometime during 1992, EPA will implement the enforceable measures to protect listed species from pesticides. At this time EPA will issue Pesticide Registration Notices to the registrants of affected pesticide products to modify their products' labeling.

The final component of the program provides an exemption for indoor uses in the case of a public health emergency where expeditious control of disease vectors, such as mosquitoes or fleas, is required.

**Table 8. How the Endangered Species Program will affect the pesticide user.**

<b>Read the label.</b>
<i>Does the label have use limitations due to endangered species?</i>
<b>Yes.</b> Obtain bulletin for the county in which the pesticide is to be applied. Detailed county maps show endangered species' locations.*
<b>No.</b> Use pesticide product according to label directions.
<i>Is the area where the pesticide is to be applied within an endangered species location?</i>
<b>Yes.</b> Determine pesticide use limitations from county bulletin.*
<b>No.</b> Use pesticide product according to label directions.

\*Note: County bulletins currently are not available.

### Consider Your Impact on the Environment

Finally, there are many things that individuals can do to protect endangered species wherever they occur. First, educate yourself about the problem. You can do this by reading about the subject or joining state or national conservation organizations that are concerned about the environment and loss of biological diversity.

- *Examine your life style and seek ways to minimize your impact on the environment.* Have you considered starting a home recycling program? You can get the whole family involved by separating newspaper and other paper products, engine oil, aluminum and steel cans, glass, and recyclable plastic containers, and taking them to a recycling center. You will be actively helping to save resources and earn some money too.

- *Have you thought of using a water-saving shower head or altering the tank on your toilet bowl so you use less water?* This will also save you money and protect our rivers and streams.

- *Become an educated consumer!* Buy products that are reusable, recyclable, environmentally safe, and energy efficient.

- *Talk to your elected officials about environmental issues.* Let them know that you will stand behind them to support environmental legislation.

- *Support the work of state and federal agencies that are attempting to protect the environment.* Did you realize that you can help protect endangered species in Kansas by contributing to the Chickadee Checkoff on your Kansas income tax form.

Another way of supporting the work of federal agencies is to purchase a Migratory Bird Stamp at your local post office. Monies received from the sales of these stamps goes toward purchasing valuable wetland habitats. Whether or not you own land that harbors endangered species, you can play an important role in protecting part of our natural heritage, endangered species.

***Where Can I Find More Information about  
Endangered Species?***

You can learn more about endangered species by contacting the following organizations and reading books.

Kansas Department of Wildlife and Parks  
RR 2, Box 54A  
Pratt, KS 67124

Kansas Biological Survey  
University of Kansas, Natural History Museum  
602 Dyche Hall  
Lawrence, KS 66045

United States Fish and Wildlife Service  
Endangered Species Field Office  
315 Houston Street  
Manhattan, KS 66502

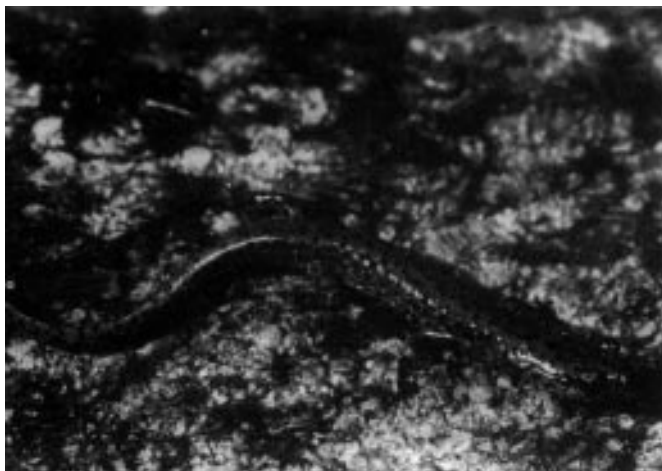

*The cave salamander is an animal that is restricted to habitats in southeastern Kansas.*



*The butterfly mussel and western fanshell mussel are state endangered species and are indicators of water quality in streams and rivers.*



*A variety of species including the state endangered least tern and peregrine falcon depend on specialized habitats.*



*The black-footed ferret is the rarest mammal in North America and historically was found in western Kansas.*



## Questions for Chapter 38

1. What is a species? an endangered species? a threatened species?
2. What is extinction?
3. What are the major reasons species become extinct, endangered, or threatened?
4. Briefly describe the intent and purpose of the Endangered Species Act of 1973 as amended.

